

ACCESSORI ACCESSORIES

Pinze DIN 6499 forma B - tipo ER <i>Spring collets DIN 6499 form B - ER type</i>	11-2
Pinze DIN 6499 <i>Spring collets DIN 6499</i>	11-2
Pinze di maschiatura con compensazione - tipo ET1 <i>Tapping collets with compensation - ET1 type</i>	11-3
Pinze di maschiatura senza compensazione - tipo ER <i>Tapping collets without compensation - ER type</i>	11-3
Pinze <i>Collets</i>	11-3
Pinze porta maschi DIN 6328 <i>Tap holder collets DIN 6328</i>	11-4
Pinze porta punte DIN 6329 <i>Tool holder collets DIN 6329</i>	11-4
Ghiere esagonali per pinze DIN 6499 <i>Exagon clamping nut for spring collets DIN 6499</i>	11-5
Ghiere equilibrate per pinze DIN 6499 <i>Balanced clamping nut for spring collets DIN 6499</i>	11-5
Ghiere per pinze DIN 6499 <i>Clamping nut for spring collets DIN 6499</i>	11-5
Insero HSK porta fresa <i>HSK mill adapters</i>	11-6
Insero HSK porta pinze per utensili a gambo cilindrico <i>HSK adapters with collet for cylindrical shank tools</i>	11-6
Chiavi per ghiere <i>Clamping nuts spanner</i>	11-7
Inseri registrabili DIN 6327/1 porta utensili a cono Morse <i>DIN 6327/1 adjustable adapters for morse taper shank tools</i>	11-8
Inseri registrabili DIN 6327/2 porta utensili a cono Morse <i>DIN 6327/2 adjustable adapters for morse taper shank tools</i>	11-8
Inseri registrabili porta utensili a cono Morse (Norma OMG) <i>Adjustable adapters for morse taper shank tools (OMG norm)</i>	11-9
Insero porta pinze per utensili a gambo cilindrico (DIN 6327) <i>DIN 6327 adjustable adapters for cylindrical shank tools</i>	11-9
Mandrini per maschiare con diametro ridotto <i>Tapping spindles with reduced diameter</i>	11-10
Mandrini a cambio rapido per maschiare con compensazione assiale <i>Quick change tapping chucks with axial compensation</i>	11-10
Mandrini a cambio rapido per maschiare con compensazione assiale e spostamento parallelo all'asse <i>Quick change tapping chucks with axial compensation and radial parallel floating</i>	11-11
Mandrini a cambio rapido per maschiare con spostamento parallelo all'asse <i>Quick change tapping chucks with radial parallel floating</i>	11-11
Mandrini a cambio rapido per maschiare con compensazione assiale <i>Quick change tapping chucks with axial compensation</i>	11-11
Bussole porta maschio a cambio rapido con frizione destra e sfere <i>Quick connection tap-holder bushes with ball right clutch</i>	11-12
Bussole porta maschio a cambio rapido <i>Quick connection tap-holder bushes</i>	11-12
Manicotti ad innesto rapido <i>Quick connection sleeves</i>	11-13
Ghiere ad innesto rapido <i>Ring nuts</i>	11-13
Trascinatori a cono Morse <i>Morse taper with driving dog</i>	11-13



FH

BAH

TA.CP

TA

MOX

HT

VH

TSI/TSX

T

MT-TC-TC3

Accessori
AccessoriesAppendice tecnica
Technical supplement

Pinze DIN 6499 forma B - tipo ER Spring collets DIN 6499 form B - ER type

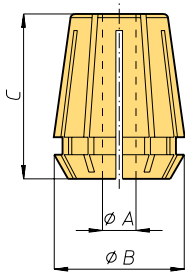

ER8		φB=8,5			C=15												
Codice Code	224400	224401	224402	224403	224404	224405	224406	224407	224408								
φA	1 - 0,5	1,5 - 1	2 - 1,5	2,5 - 2	3 - 2,5	3,5 - 3	4 - 3,5	4,5 - 4	5 - 4,5								
ER11		φB=11,5			C=18												
Codice Code	224411	224412	224413	224414	224415	224416	224417	224418	224419	224420	224421	224422	224423				
φA	1 - 0,5	1,5 - 1	2 - 1,5	2,5 - 2	3 - 2,5	3,5 - 3	4 - 3,5	4,5 - 4	5 - 4,5	5,5 - 5	6 - 5,5	6,5 - 6	7 - 6,5				
ER16		φB=17			C=27,5												
Codice Code	224426	224424	224425	224467	224436	224429	224430	224431	224432	224433	224434	224435					
φA	1 - 0,5	1,5 - 1	2 - 1,5	2,5 - 2	3 - 2,5	4 - 3	5 - 4	6 - 5	7 - 6	8 - 7	9 - 8	10 - 9					
ER20		φB=21			C=31,5												
Codice Code	224451	224437	224450	224409	224410	224440	224441	224442	224443	224444	224445	224446	224447	224448	224449		
φA	1 - 0,5	1,5 - 1	2 - 1,5	2,5 - 2	3 - 2,5	4 - 3	5 - 4	6 - 5	7 - 6	8 - 7	9 - 8	10 - 9	11 - 10	12 - 11	13 - 12		
ER25		φB=26			C=34												
Codice Code	224468	224469	224470	224471	224472	224454	224455	224456	224457	224458	224459	224460	224461	224462	224463	224464	
φA	1 - 0,5	1,5 - 1	2 - 1,5	2,5 - 2	3 - 2,5	4 - 3	5 - 4	6 - 5	7 - 6	8 - 7	9 - 8	10 - 9	11 - 10	12 - 11	13 - 12	14 - 13	
Codice Code	224465	224466	224550														
φA	15 - 14	16 - 15	16 - 17														
ER32		φB=33			C=40												
Codice Code	224473	224474	224476	224477	224478	224479	224480	224481	224482	224483	224484	224485	224486	224487			
φA	2,5 - 2	3 - 2,5	4 - 3	5 - 4	6 - 5	7 - 6	8 - 7	9 - 8	10 - 9	11 - 10	12 - 11	13 - 12	14 - 13	15 - 14			
Codice Code	224488	224489	224490	224491	224492	224551	224552										
φA	16 - 15	17 - 16	18 - 17	19 - 18	20 - 19	21 - 20	22 - 21										
ER40		φB=41			C=46												
Codice Code	224499	224500	224501	224502	224503	224504	224505	224506	224507	224508	224509	224510	224511	224512	224513		
φA	3 - 2	4 - 3	5 - 4	6 - 5	7 - 6	8 - 7	9 - 8	10 - 9	11 - 10	12 - 11	13 - 12	14 - 13	15 - 14	16 - 15	17 - 16		
Codice Code	224514	224515	224516	224517	224518	224519	224520	224521	224522	224523	224524	224525	224526				
φA	18 - 17	19 - 18	20 - 19	21 - 20	22 - 21	23 - 22	24 - 23	25 - 24	26 - 25	27 - 26	28 - 27	29 - 28	30 - 29				
ER50		φB=52			C=60												
Codice Code	224530	224531	224532	224533	224534	224535	224536	224537	224538	224539	224540	224541	224542	224543	224544	224545	224546
φA	6 - 4	8 - 6	10 - 8	12 - 10	14 - 12	16 - 14	18 - 16	20 - 18	22 - 20	24 - 22	25 - 23	26 - 24	28 - 26	30 - 28	32 - 30	34 - 32	36 - 34

Pinze DIN 6499 Spring collets DIN 6499

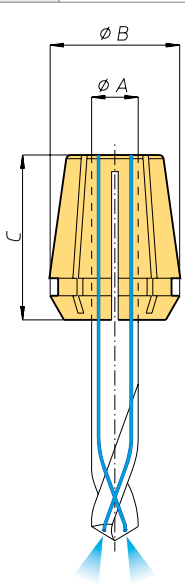

ER16 UPV		φB=17			C=27,5										
Codice Code	235205	235206	235207	235208	235209	235210	235211	235212							
φA	3	4	5	6	7	8	9	10							
ER20 UPV		φB=21			C=31,5										
Codice Code	235215	235216	235217	235218	235219	235220	235221	235222	235223	235224	235225				
φA	3	4	5	6	7	8	9	10	11	12	13				
ER25 UPV		φB=26			C=34										
Codice Code	235228	235229	235230	235231	235232	235233	235234	235235	235236	235237	235238	235239	235240	235241	
φA	3	4	5	6	7	8	9	10	11	12	13	14	15	16	
ER32 UPV		φB=33			C=40										
Codice Code	235246	235247	235248	235249	235250	235251	235252	235253	235254	235255	235256	235257	235258	235259	235260
φA	3	4	5	6	7	8	9	10	11	12	13	14	15	16	17
Codice Code	235261	235262	235263												
φA	18	19	20												
ER40 UPV		φB=41			C=46										
Codice Code	235266	235267	235268	235269	235270	235271	235272	235273	235274	235275	235276	235277	235278	235279	235280
φA	4	5	6	7	8	9	10	11	12	13	14	15	16	17	18
Codice Code	235281	235282	235283	235284	235285	235286	235287	235288							
φA	19	20	21	22	23	24	25	26							



Pinze di maschiatura con compensazione - tipo ET1*
Tapping collets with compensation - ET1 type*

ET 1-12	A=21,5			φB=11,5		C=5,5		CAPACITÀ M2 - M4		
Codice Code	224650	224651	224652	224653	224654					
φA	1,4	2,2	2,5	2,8	3,5					
ET 1-16	A=27			φB=17		C=7		CAPACITÀ M2 - M8		
Codice Code	224658	224659	224660	224661	224662	224663	224664	224665		
φA	1,4	2,2	2,5	2,8	3,5	4	4,5	6		
ET 1-20	A=31			φB=21		C=7		CAPACITÀ M2 - M10		
Codice Code	224670	224671	224672	224673	224674	224675	224676	224677		
φA	2,2	2,5	2,8	3,5	4	4,5	6	7		
ET1-25	A=34			φB=26		C=8		CAPACITÀ M2 - M12		
Codice Code	224682	224683	224684	224685	224686	224687	224688	224689	224690	224691
φA	2,2	2,5	2,8	3,5	4	4,5	6	7	8	9
ET 1-32	A=43			φB=33		C=10		CAPACITÀ M35 - M16		
Codice Code	224695	224696	224697	224698	224699	224700	224701	224702	224703	
φA	4	4,5	6	7	8	9	10	11	12	
ET 1-40	A=54			φB=41		C=13		CAPACITÀ M5 - M20		
Codice Code	224706	224707	224708	224709	224710	224711	224712	224713	224714	
φA	6	7	8	9	10	11	12	14	16	

*Not suitable for coolant through (tool)

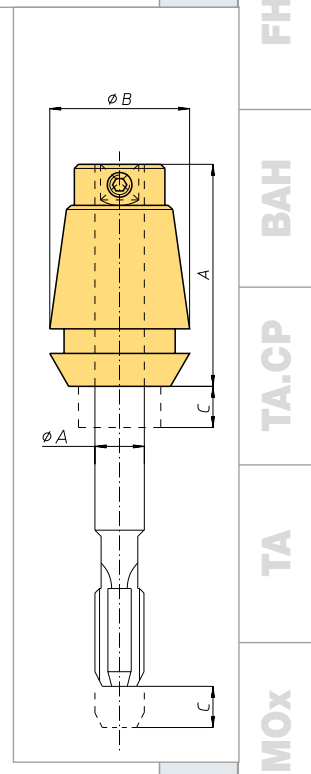

Pinze di maschiatura senza compensazione - tipo ER
Tapping collets without compensation - ER type

ER 16 GB	φB=16		C=27,5									
Codice Code	224585	224587	22458	224589	224590							
φA	4,5	6	7	8	9							
ER 20 GB	φB=20		C=31,5									
Codice Code	224593	224595	224596	224597	224598	224599	224600					
φA	4,5	6	7	8	9	10	11					
ER 25 GB	φB=25		C=34									
Codice Code	224604	224606	224607	224608	224609	224610	224611	224612	224613	224614		
φA	4,5	6	7	8	9	10	11	12	14	16		
ER 32 GB	φB=32		C=40									
Codice Code	224617	224619	224620	224621	224622	224623	224624	224625	224626	224627	224628	224629
φA	4,5	6	7	8	9	10	11	12	14	16	18	20
ER 40 GB	φB=40		C=46									
Codice Code	224634	224635	224636	224637	224638	224639	224640	224641	224642	224643	224644	224645
φA	6	7	8	9	10	11	12	14	16	18	20	22

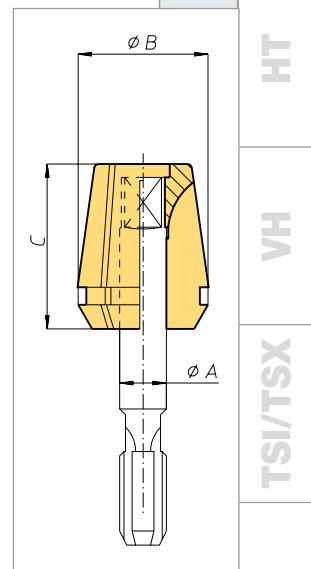

Pinze Collets

6023E	φB=6,5		C=20		D=M5x0,6		SW=5,5		β°=20°		Coppia serraggio (Nm)=3	
Codice Code	224740	224741	224742	224743	224746							
φA	1	1,5	2	2,5	3							
600E	φB=9		C=28,5		D=M6x0,75		SW=7		β°=20°		Coppia serraggio (Nm)=5	
Codice Code	224574	224575	224576	224577	224578	224579						
φA	1,5	2	2,5	3	3,5	4						
601E	φB=11		C=33		D=M8x0,75		SW=9		β°=20°		Coppia serraggio (Nm)=9	
Codice Code	224728	224729	224730	224731	224732	224733	224734	224735	224736	224737		
φA	1,5	2	2,5	3	3,5	4	4,5	5	5,5	6		

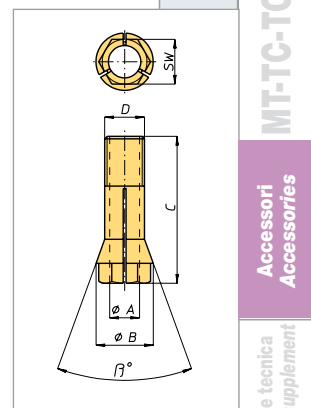

FH

BAH

TA.CP

TA

MOX

HT

VH

TSI/TSX

T

MT-TC-TC3

Accessori
Accessories

Appendice tecnica
Technical supplement

Pinze porta maschi DIN 6328
Tapholder collets DIN 6328

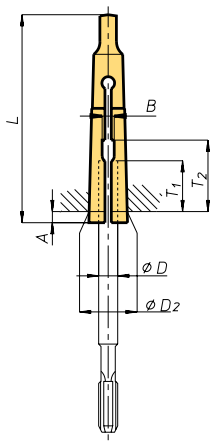

DIN 6328 - CONO MORSE 1									
D	2,5	2,8	3,5	4	4,5	6	7	8	9
Codice Code	224000	224002	224008	224010	224012	224018	224022	224024	224026
B	2,2	2,2	2,8	3,1	3,5	5,1	5,7	6,3	7,3
T1	15	15	16	16	18	19,5	19,5	22	25
T2	19	19	21	24	24	26	27	30	32

DIN 6328 - CONO MORSE 2									
D	6	7	8	9	10	11	12		
Codice Code	224112	224116	224120	224122	224126	224128	224134		
B	5,1	5,7	6,4	7,3	8,3	9,3	9,3		
T1	19,5	19,5	19,5	22	23	24	24		
T2	26	26	27	22	32	34	34		

Pinze porta punte DIN 6329
Toolholder collets DIN 6329

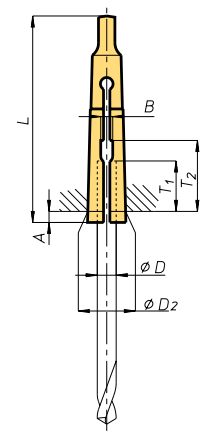

DIN 6329 - CONO MORSE 1																					
D	3	3,2	3,5	3,75	4	4,25	4,5	4,75	5	5,25	5,5	5,75	6	6,25	6,5	6,75	7	7,25	7,5	7,75	8
Codice Code	224164	224166	224168	224170	224172	224174	224176	224178	224180	224182	224184	224186	224188	224190	224192	224194	224196	224198	224200	224202	224204
B	1,8		2,2		2,4		2,7		3,2			3,8									
T1					20				22				22								
T2	25				26				29				29								

DIN 6329 - CONO MORSE 2																			
D	5,5	6	6,5	7	7,5	8	8,5	9	9,5	10	10,5	11	11,5	12	12,5	13			
Codice Code	224260	224262	224264	224266	224268	224270	224272	224274	224276	224278	224280	224282	224284	224286	224288	224290			
B	3,2		3,8			4,8			5,3			6,3							
T1	22				25				28										
T2	29				33				37				39						

FH
BAH
TA.CP
TA
MOX
HT
VH
TSI/TSX
T
MT-TC-TC3
Accessori
Accessories
Appendice tecnica
Technical supplement



Ghiere esagonali per pinze DIN 6499 Exagon clamping nut for spring collets DIN 6499

Ghiera Nut	Codice Code	φA	B	SW	Coppia serraggio Clamping force (Nm)
ER 11AE	224980	M18 x1	9	15	24 (30)
ER 16AE	224981	M24 x1	12	19	40 (50)
ER 20AE	224982	M28 x1,5	13	22	52 (65)
ER 25AE	224983	M32 x1,5	16,5	27	80 (100)
ER 32AE	224984	M40 x1,5	19	32	104 (130)

Tra parentesi valore massimo - Between brackets max. value

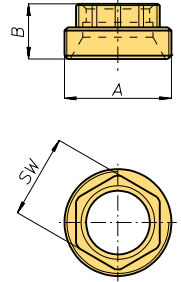

Ghiere regofix per pinze DIN 6499 Regofix clamping nut for spring collets DIN 6499

Ghiera Nut	Codice Code	φA	B	Wrench	Coppia serraggio Clamping force (Nm)	
					Pinze con scarico Spring collet with extractor	Pinze senza scarico Spring collet without extractor
HI-Q/ER AX 11	224951	M18 x1	7,5	E 11 AX	21 (25)	24 (29)
HI-Q/ER AX 16	224950	M24 x1	7,6	E 16 AX	40 (50)	40 (50)
HI-Q/ER AX 20	224952	M28 x1,5	8,5	E 20 AX	35 (42)	40 (50)
HI-Q/ER AX 25	224953	M32 x1,5	8,8	E 25 AX	64 (80)	64 (80)
HI-Q/ER AX 32	224954	M40 x1,5	9,8	E 32 AX	72 (90)	104 (125)

Tra parentesi valore massimo - Between brackets max. value

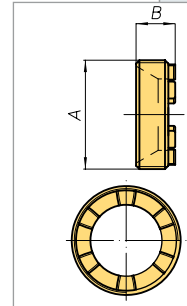

Ghiere per pinze DIN 6499 Clamping nut for spring collets DIN 6499

Ghiera Nut	Codice Code	φA	B	C	Coppia serraggio Clamping force (Nm)	
					Pinze con scarico Spring collet with extractor	Pinze senza scarico Spring collet without extractor
ER 8M	224900	11,8	10,8	M10 x 0,75	5 (6)	5 (6)
ER 11M	224902	16	12	M13 x 0,75	12 (15)	16 (20)
ER 16M	224904	22	18	M19 x 1	24 (30)	24 (30)
ER 20M	224906	28	21	M24 x 1	28 (35)	28 (35)
ER 25M	224908	35	20	M30 x 1	32 (40)	32 (40)
ER 11 S	224985	19	11,3	M14 x 0,75	16 (19)	24 (30)
ER 16 S	224932	28	17,5	M22 x 1,5	44 (53)	56 (70)
ER 20 S	224935	34	19	M25 x 1,5	35 (42)	80 (100)
ER 25 S	224974	42	20	M32 x 1,5	64 (80)	104 (130)
ER 32 S	224975	50	22,5	M40 x 1,5	136 (170)	136 (170)
ER 40 S	224976	63	25,5	M50 x 1,5	176 (220)	176 (220)
ER 50 S	224986	78	35,3	M64 x 2	240 (300)	240 (300)
HI-Q/ER 11	224933	19	11,3	M14 x 0,75	16 (19)	24 (30)
HI-Q/ER 16	224909	28	17,5	M22 x 1,5	44 (53)	56 (70)
HI-Q/ER 20	224910	34	19	M25 x 1,5	35 (42)	80 (100)
HI-Q/ER 25	224912	42	20	M32 x 1,5	64 (80)	104 (130)
HI-Q/ER 32	224914	50	22,5	M40 x 1,5	136 (170)	136 (170)
HI-Q/ER 40	224916	63	25,5	M50 x 1,5	176 (220)	176 (220)
HI-Q/ER 50	224918	78	35,3	M64 x 2	240 (300)	240 (300)

Tra parentesi valore massimo - Between brackets max. value

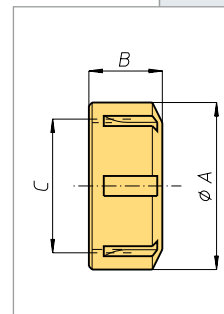
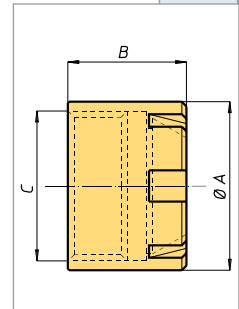

FH
BAH
TA.CP
TA
MOX
HT
VH
TSI/TSX
T
MT-TC-TC3
Accessori
Accessories



FH

BAH

TA.CP

TA

MOX

HT

VH

TSI/TSX

T

MT-TC-TC3

Accessori
Accessories

Appendice tecnica
Technical supplement

Inserto HSK porta fresa HSK mill adapters

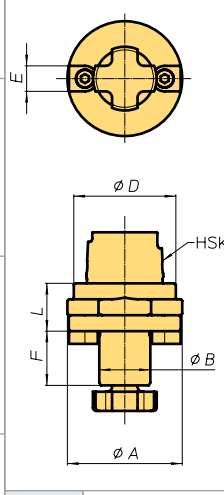

Codice Code	Grandezza Size	HSK	φA	φB	φD	E	F	L	Vite Screw	Chiave* Wrench*
009401	HSK 32-16	32	36	16	32	8	17	15	M8	097419
009419	HSK 32-22	32	54	22	32	10	19	22	M10	097415
009404	HSK 40-16	40	40	16	40	8	17	15	M8	097419
009405	HSK 40-22	40	54	22	40	10	19	22	M10	097415
009416	HSK 50-22	50	54	22	50	10	19	23	M10	097416
009406	HSK 50-27	50	64	27	50	12	21	23	M12	097416
009417	HSK 63-27	63	64	27	64	12	21	25	M12	097416
009408	HSK 63-32	63	74	32	63	14	24	25	M16	097417
009414	HSK 80-32	80	80	32	80	14	24	35	M16	097417
009413	HSK 80-40	80	80	40	80	16	27	35	M20	097591

* Le chiavi non sono comprese - * The wrench aren't included

Inserto HSK porta pinze per utensili a gambo cilindrico HSK adapters with collet for cylindrical shank tools

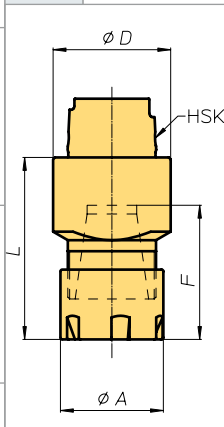

Codice Code	Grandezza Size	HSK	Pinza Collet	φA	φD	F	L	Ghiera Nut
009400	HSK 32-ER 20M	32	ER 20	28	32	37,5	49,5	ER 20M
009402	HSK 32-ER 25M	32	ER 25	35	32	41	53	ER 25M
009415	HSK 40-ER 20M	40	ER 20	28	40	37,5	49,5	ER 20M
009403	HSK 40-ER 25M	40	ER 25	35	40	41	54	ER 25M
009418	HSK 40-ER 32M	40	ER 32	50	42	47	59,5	ER 32UM
009407	HSK 50-ER 32	50	ER 32	50	50	47	64	ER 32UM
009409	HSK 63-ER 32	63	ER 32	50	63	47	65	ER 32UM
009410	HSK 63-ER 40	63	ER 40	63	63	53	71	ER 40UM
009411	HSK 80-ER 40	80	ER 40	63	80	53	73,5	ER 40UM
009412	HSK 80-ER 50	80	ER 50	78	80	69	91,5	ER 50UM

Inserto HSK Weldon/Whistle Notch Adapter HSK Weldon/Whistle Notch

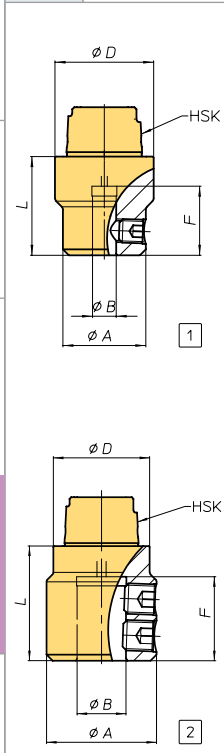

Codice Code	Grandezza Size	HSK	φA	φD	F	L	B	TIPO Type
228220	HSK 32 W8	32	28	32	30	45	8	1
228221	HSK 32 W10	32	32	32	30	45	10	
228222	HSK 32 W12	32	32	32	35	50	12	
228223	HSK 40 W8	40	28	40	30	45	8	
228224	HSK 40 W10	40	35	40	30	45	10	
228225	HSK 40 W12	40	40	40	35	50	12	
228226	HSK 40 W16	40	40	40	40	55	16	
228227	HSK 50 W8	50	28	50	30	45	8	
228228	HSK 50 W10	50	35	50	30	45	10	
228229	HSK 50 W12	50	42	50	35	50	12	
228230	HSK 50 W16	50	50	50	40	55	16	
228231	HSK 50 W20	50	50	50	45	60	20	
228232	HSK 63 W8	63	28	63	30	45	8	2
228233	HSK 63 W10	63	35	63	30	45	10	
228234	HSK 63 W12	63	42	63	35	50	12	
228235	HSK 63 W16	63	50	63	40	55	16	
228236	HSK 63 W20	63	52	63	45	60	20	
228237	HSK 63 W25	63	63	63	50	70	25	
228238	HSK 63 W32	63	72	63	55	75	32	

**Chiavi per ghiera
Clamping nuts spanner**

Chiavi Spanner	Codice chiave Spanner code	Per ghiera For clamping nut	Codice ghiera Clamping nut code
CE 8M	231300	ER 8M	224900
CE 11M	231302	ER 11M	224902
CE 16M	231306	ER 16M	224904
CE 20M	231309	ER 20M	224906
CE 25M	231313	ER 25M	224908

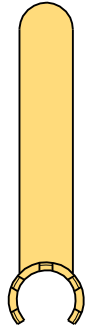

Chiavi Spanner	Codice chiave Spanner code	Per ghiera For clamping nut	Codice ghiera Clamping nut code
CE 20U	231315	ER 20UM	224973
CE 25U	231314	ER 25UM	224974
CE 32U	231320	ER 32UM	224975
CE 40U	231321	ER 40UM	224976
CE 50U	231323	ER 50UM	224986

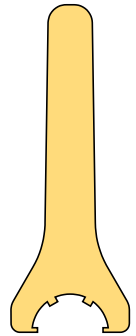

**Chiavi per ghiera
Clamping nuts spanner**

Chiavi Spanner	Codice chiave Spanner code	Per ghiera For clamping nut	Codice ghiera Clamping nut code
E 11 AX	231356	ERAX11	224951
E 16 AX	231357	ERAX16	224950
E 20 AX	231358	ERAX20	224952
E 25 AX	231359	ERAX25	224953
E 32 AX	231360	ERAX32	224954

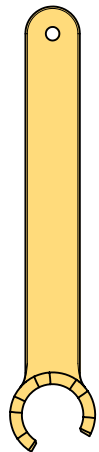

**Chiavi per viti
Spanner screw**

Chiavi Spanner	Codice Code	Inserito HSK HSK mill adapter
CM8	097419	HSK 32-16 HSK 40-16
CM10	097415	HSK 40-22 HSK 50-22
CM12	097416	HSK 50-27 HSK 63-27
CM16	097417	HSK 63-32 HSK 80-32
CM20	097591	HSK 80-40

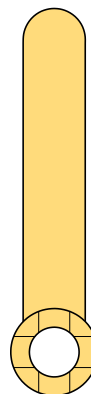

FH

BAH

TA.CP

TA

MOX

HT

VH

TSI/TSX

T

MT-TC-TC3

Accessori
Accessories

Appendice tecnica
Technical supplement



Inserti registrabili DIN 6327/1 porta utensili a cono Morse
DIN 6327/1 adjustable adapters for morse taper shank tools

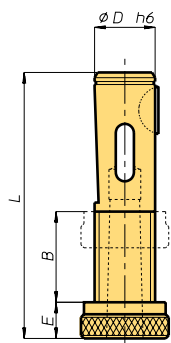

Codice Code	Grandezza Size	Cono Morse Morse taper	ϕD^{h6}	Filettatura Thread	B	E	L	Linguetta Woodruff key
009010	D 16 x 1	1	16	Tr 16 x 1,5	28	12	85	5 x 6,5
009012	D 20 x 1	1	20	Tr 20 x 2	28	12	88	5 x 7,5
009014	D 25 x 2	2	25	Tr 25 x 2	30	12	95	6 x 9
009016	D 28 x 2	2	28	Tr 28 x 2	30	12	95	6 x 9
009018	D 32 x 3	3	32	Tr 32 x 2	36	12	118	8 x 11
009020	D 36 x 3	3	36	Tr 36 x 2	36	14	118	8 x 11
009022	D 48 x 4	4	48	Tr 48 x 2	47	18	144	10 x 13

Inserti registrabili DIN 6327/2 porta utensili a cono Morse
DIN 6327/2 adjustable adapters for morse taper shank tools

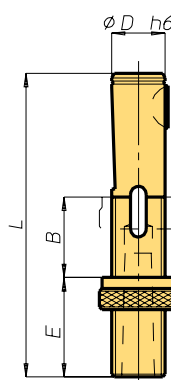

Codice Code	Grandezza Size	Cono Morse Morse taper	ϕD^{h6}	Filettatura Thread	B	E	L	Linguetta Woodruff key
009024	F 16 x 1 x 25	1	16	Tr 16 x 1,5	28	37	110	5 x 6,5
009026	F 16 x 1 x 50					62	135	
009028	F 16 x 1 x 75					87	160	
009030	F 16 x 1 x 100					112	185	
009032	F 20 x 1 x 25	1	20	Tr 20 x 2	28	37	113	5 x 7,5
009034	F 20 x 1 x 50					62	38	
009036	F 20 x 1 x 75					87	163	
009038	F 20 x 1 x 100					112	188	
009040	F 25 x 2 x 25	2	25	Tr 25 x 2	30	37	120	6 x 9
009042	F 25 x 2 x 50					62	145	
009044	F 25 x 2 x 75					87	170	
009046	F 25 x 2 x 100					112	195	
009048	F 28 x 2 x 25	2	28	Tr 28 x 2	30	37	120	6 x 9
009050	F 28 x 2 x 50					62	145	
009052	F 28 x 2 x 75					87	170	
009054	F 28 x 2 x 100					112	195	
009056	F 32 x 3 x 25	3	32	Tr 32 x 2	36	37	148	8 x 11
009058	F 32 x 3 x 50					62	178	
009060	F 32 x 3 x 75					87	208	
009062	F 32 x 3 x 100					112	238	
009064	F 36 x 3 x 25	3	36	Tr 36 x 2	36	37	148	8 x 11
009066	F 36 x 3 x 50					62	178	
009068	F 36 x 3 x 75					87	208	
009070	F 36 x 3 x 100					112	238	
009072	F 48 x 4 x 25	4	48	Tr 48 x 2	47	37	184	10 x 13
009074	F 48 x 4 x 50					62	224	
009076	F 48 x 4 x 75					87	264	
009078	F 48 x 4 x 100					112	304	

FH
BAH
TA.CP
TA
MOX
HT
VH
TSI/TSX
T
MT-TC-TC3
Accessori
Accessories
Appendice tecnica
Technical supplement



Inserti registrabili porta utensili a cono Morse (Norma OMG)
Adjustable adapters for morse taper shank tools (OMG norm)

Codice Code	Grandezza Size	Cono Morse Morse taper	ϕD^{h6}	Filettatura Thread	ϕA	B	E	L	Linguetta Woodruff key
009110	Tr 8 x 1	1	8	Tr 8 x 1	16,8	16	84	126	2 x 3,7
009116	Tr 10 x 1	1	10	Tr 10 x 1,5	19,5	18	89	138	3 x 5
009122	Tr 12 x 1	1	12	Tr 12 x 1,5	22	18	91	138	3 x 5

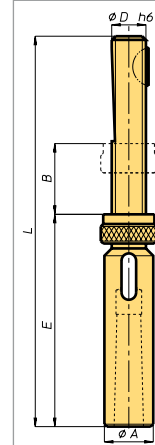

Inserto porta pinze per utensili a gambo cilindrico (DIN 6327)
DIN 6327 adjustable adapters for cylindrical shank tools

Codice Code	Grandezza Size	ϕD^{h6}	Filettatura Thread	ϕA	B	E	F	L	Pinza Collet	Linguetta Woodruff key
009112	Tr 8 ER 8	8	Tr 8 x 1	12	16	36	23	75	ER 8	2 x 3,7
009114	Tr 8 ER 11	8	Tr 8 x 1	16	16	41	28	80	ER 11	2 x 3,7
009118	Tr 10 ER 11	10	Tr 10 x 1,5	16	18	43	28	93	ER 11	3 x 5
009120	Tr 10 ER 16	10	Tr 10 x 1,5	22	18	54	39	104	ER 16	3 x 5
009124	Tr 12 ER 16	12	Tr 12 x 1,5	22	18	56	39	106	ER 16	3 x 5
009130	Tr 16 ER 20	16	Tr 16 x 1,5	28	28	65	47	136	ER 20	5 x 6,5
009140	Tr 20 ER 20	20	Tr 20 x 2	32	28	65	47	139	ER 20	5 x 7,5
009145	Tr 20 ER 25	20	Tr 20 x 2	35	28	61	44	135	ER 25	5 x 7,5
009170	Tr 28 ER 32	28	Tr 28 x 2	50	30	65	49	147	ER 32	6 x 9

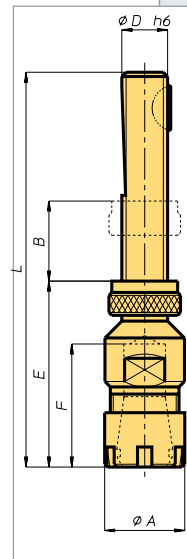

FH

BAH

TA.CP

TA

MOX

HT

VH

TSI/TSX

T

MT-TC-TC3

Accessori
Accessories

Appendice tecnica
Technical supplement

FH

BAH

TA.CP

TA

MOX

HT

VH

TSI/TSX

T

MT-TC-TC3

Accessori
Accessories

Appendice tecnica
Technical supplement

Mandrini OMG per maschiare con diametro ridotto OMG tapping spindles with reduced diameter

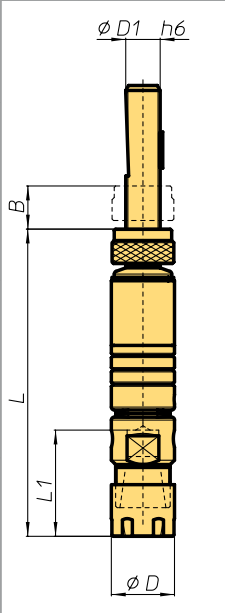

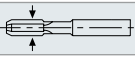
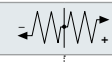
Codice Code	Mandrino Spindle			ØD	D1	L	L1	B	Pinza Collet	
009450	MM.Tr8.ER8	M5	0,5	8	15	8	75	23	16	ER8
009453	MM.Tr8.ER11	M6	1	10	19	8	90	27	16	ER11
009451	MM.Tr10.ER11	M6	1	10	19	10	90	27	18	ER11
009454	MM.Tr10.ER16	M8	1	10	22	10	105	37	18	ER16
009452	MM.Tr12.ER16	M8	1	10	22	12	107	37	18	ER16

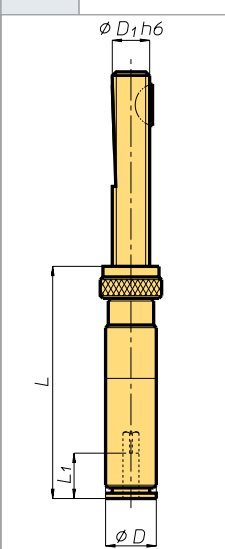

Mandrini per maschiare con diametro ridotto Tapping spindles with reduced diameter

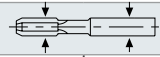

Codice Code	Mandrino Spindle		ØD	D1	L	L1
227030	MR. 0 - 10x1.5 Tpz	M1 - M10	14	10	44	15
227031	MR. 0 - 12x1.5 Tpz			12		
227032	MR. 1 - 12x1.5 Tpz	M4 - M14	19	12	52	17
227033	MR. 1 - 16x1.5 Tpz			16		
227034	MR. 2 - 20x2 Tpz	M8 - M24	31	20	77	30
227035	MR. 2 - 28x2 Tpz			28		
227036	MR. 3 - 28x2 Tpz	M14 - M36	48	28	95	44
227037	MR. 3 - 36x2 Tpz			36		
227038	MR. 4 - 36x2 Tpz	M22 - M48	60	36	132	71
227039	MR. 4 - 48x2 Tpz			48		

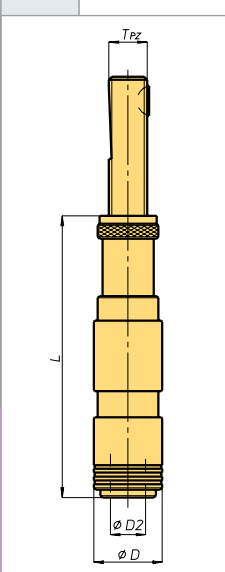
Mandrini a cambio rapido per maschiare con compensazione assiale Quick change tapping clucks with axial compensation



Mandrino Spindle		D	D2			16x1.5 Tpz	Codice Code	20x2 Tpz	Codice Code	28x2 Tpz	Codice Code	36x2 Tpz	Codice Code	
MF 0-5D-20-10	M1 - M10	23	13	20	10	0	116	227060	116	227061				
MF 0-5D-15-15				15	15	111	227062	111	227063					
MF 0-5D-0-30				0	30	96	227064	96	227065					
MF 1-5D-30-10	M3 - M12	35	19	30	10	1	148	227066	148	227067	148	227068		
MF 1-5D-20-20				20	20	138	227069	138	227070	138	227071			
MF 1-5D-0-40				0	40	118	227072	118	227073	118	227074			
MF 2-4D-30-10	M8 - M20	50	31	30	10	2			172	227075	172	227076	172	227077
MF 2-4D-20-20				20	20			162	227078	162	227079	162	227080	
MF 2-4D-0-40				0	40			142	227081	142	227082	142	227083	
MF 3-3D-30-10	M14 - M33	72	48	30	10					218	227084	218	227085	
MF 3-3D-20-20				20	20			208	227086	208	227087			
MF 3-3D-0-40				0	40			188	227088	188	227089			

Mandrini a cambio rapido per maschiare con compensazione assiale e spostamento parallelo all'asse
Quick change tapping chucks with axial compensation and radial parallel floating

Mandrino Spindle	D	D2	\pm	\leftarrow \rightarrow	\leftarrow \rightarrow	16x1.5 Tpz	Codice Code	20x2 Tpz	Codice Code	28x2 Tpz	Codice Code	36x2 Tpz	Codice Code	
MFC 0-5D-20-10	M1 - M10	23	13	0,25	20	10	0	138	227090	138	227091			
MFC 0-5D-15-15					15	15		133	227092	133	227093			
MFC 0-5D-0-30					0	30		118	227094	118	227095			
MFC 1-5D-30-10	M3 - M12	35	19	0,5	30	10	1	163	227096	163	227097	163	227098	
MFC 1-5D-20-20					20	20		153	227099	153	227100	153	227101	
MFC 1-5D-0-40					0	40		133	227102	133	227103	133	227104	
MFC 2-4D-30-10	M8 - M20	50	31	1	30	10	2		196	227105	196	227106	174	227077
MFC 2-4D-20-20					20	20			186	227108	186	227109	164	227080
MFC 2-4D-0-40					0	40			166	227111	166	227112	144	227083
MFC 3-3D-30-10	M14 - M33	72	48	1,5	30	10	3			252	227084	220	227085	
MFC 3-3D-20-20					20	20				242	227116	210	227087	
MFC 3-3D-0-40					0	40				222	227118	190	227089	

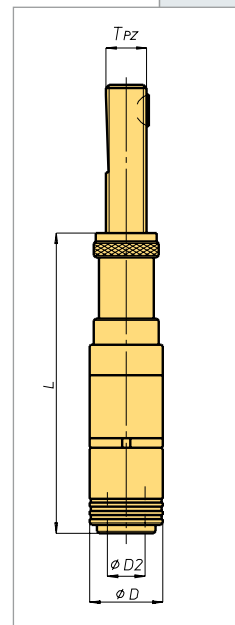

Mandrini a cambio rapido per maschiare con spostamento parallelo all'asse
Quick change tapping chucks with radial parallel floating

Mandrino Spindle	D	D2	\pm	\leftarrow \rightarrow	16x1.5 Tpz	Codice Code	20x2 Tpz	Codice Code	28x2 Tpz	Codice Code	36x2 Tpz	Codice Code
MFC 0	M1 - M10	23	13	0,25	0	65	227131	65	227132			
MFC 1	M3 - M12	35	19	0,5	1	70	227133	70	227134	70	227135	
MFC 2	M8 - M20	50	31	1	2		96	227136	96	227137	98	227138
MFC 3	M14 - M33	72	48	1,5	3				136	227139	138	227146

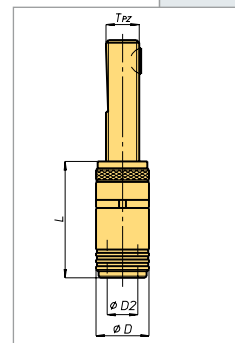

Mandrini a cambio rapido per maschiare con compensazione assiale
Quick change tapping chucks with axial compensation

Codice Code	Mandrino Spindle	D	D1	D2	D3	D4	L	L1	L2 min.	L3 min.	L4	L5	G	Chiavetta DIN 6885			
227185	MKD0.GC M1 - M10	0	6,5	6,5	26	15	13	8,2	6	37	32	18,5	11	6	3	M5	5x3x12
227186	MKD1.GC M3 - M12	1	7,5	7,5	36	20	19	11,2	9	39	33	24,5	11	6	3	M6	6x4x16
227187	MKD2.GC M8 - M20	2	12,5	12,5	53	25	31	13,2	11	63	39	30,5	20	8	4	M8	6x6x20

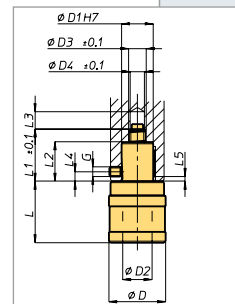

Mandrini a cambio rapido per maschiare con compensazione assiale
Quick change tapping chucks with axial compensation

Mandrino Spindle	\pm	\leftarrow \rightarrow	\leftarrow \rightarrow	\varnothing D	\varnothing D2	28x2 Tpz	Codice Code	36x2 Tpz	Codice Code	48x2 Tpz	Codice Code	
AKD 1 - ..	M3 - M12	1	20	20	32	19	65	227190	67	227191	71	227192
AKD 2 - ..	M8 - M20	2	20	25	50	31		83	227193	87	227194	
AKD 40 - ..	M6 - M18	4	20	20	40	26	80	227195				

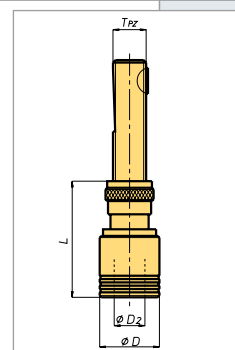

Mandrini a cambio rapido per maschiare con compensazione assiale
Quick change tapping chucks with axial compensation

Mandrino Spindle	\pm	\leftarrow \rightarrow	\leftarrow \rightarrow	\varnothing D	\varnothing D2	16x1.5 Tpz	Codice Code	20x2 Tpz	Codice Code	28x2 Tpz	Codice Code	36x2 Tpz	Codice Code
MKD-0 - Tr..	M1 - M10	0	6,5	6,5	26	13	50	227165	50	227166			
MKD-1 - Tr..	M1 - M12	1	7,5	7,5	36	19	52	227167	52	227168	52	227169	
MKD-2 - Tr..	M4 - M20	2	12,5	12,5	53	31		76	227171	76	227172	78	227173
MKD-3 - Tr..	M4 - M33	3	20	20	78	48						111	227175

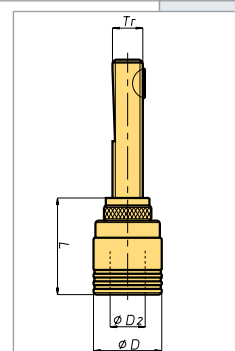

FH

BAH

TA.CP

TA

MOX

HT

VH

TSI/TSX

T

MT-TC-TC3

Accessori Accessories

Appendice tecnica Technical supplement

FH

BAH

TA.CP

TA

MOX

HT

VH

TSI/TSX

T

MT-TC-TC3

Accessori
Accessories

Appendice tecnica
Technical supplement

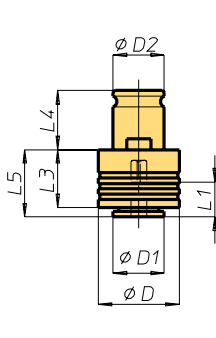

Bussole porta maschio a cambio rapido con frizione destra e sfere
Quick connection tap-holder bushes with ball right clutch

Codice Code	Bussola Bush		Ø gambo maschio Tap shank diametre	ØD	ØD1	ØD2	L1	L3	L4	L5
227206	BFS 0	M1 - M10	2,5 - 7,2	23	13	13	15	20	19,5	21
227207	BFS 1	M3 - M12	3,5 - 11,3	32	19	19	17	25	21,5	25
227208	BFS 2	M8 - M20	7 - 18	50	30	31	30	31	35	34
227209	BFS 3	M14 - M33	11 - 28	72	48	48	44	41	55,5	45
227210	BFS 40	M6 - M18	6 - 14	40	25	26	30	27	32	30

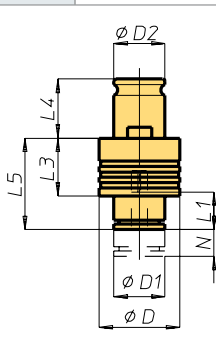

Bussole porta maschio a cambio rapido con frizione destra e sfere
Quick connection tap-holder bushes with ball right clutch

Codice Code	Bussola Bush		Ø gambo maschio Tap shank diametre	N	ØD	ØD1	ØD2	L1	L3	L4	L5
227211	BFSR 0	M1 - M10	2,5 - 7,2	8	23	13	13	15	20	19,5	28
227212	BFSR 1	M2 - M12	3,5 - 11,3	10	32	19	19	17	25	21,5	33
227213	BFSR 2	M8 - M20	7 - 18	15	50	30	31	30	31	35	59
227214	BFSR 3	M14 - M33	11 - 28	25	72	48	48	44	41	55,5	82

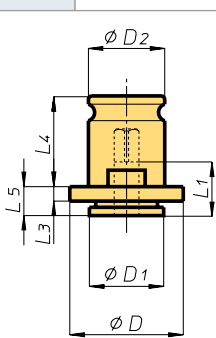

Bussole porta maschio a cambio rapido
Quick connection tap-holder bushes

Codice Code	Bussola Bush		Ø gambo maschio Tap shank diametre	ØD	ØD1	ØD2	L1	L3	L4	L5
227250	BFC 0	M1 - M10	2,5 - 7,2	22	13	13	15	4	19,5	7
227251	BFC 1	M3 - M12	3,5 - 11,3	30	19	19	17	4	21,5	7
227252	BFC 2	M8 - M20	7 - 18	48	30	31	30	5	35	11
227253	BFC 3	M14 - M33	11 - 28	70	48	48	44	6	55,5	14
227254	BFC 40	M6 - M18	6 - 14	40	25	26	30	5	32	13

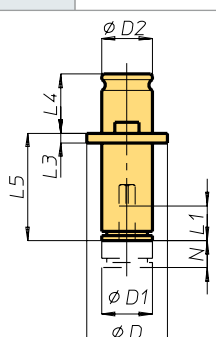

Bussole porta maschio a cambio rapido
Quick connection tap-holder bushes

Codice Code	Bussola Bush		Ø gambo maschio Tap shank diametre	N	ØD	ØD1	ØD2	L1	L3	L4	L5
227255	BFCR 0	M1 - M10	2,5 - 7,2	8	22	13	13	15	4	19,5	28
227256	BFCR 1	M2 - M12	3,5 - 11,3	10	30	19	19	17	4	21,5	33
227257	BFCR 2	M8 - M20	7 - 18	15	48	30	31	30	5	35	59
227258	BFCR 3	M14 - M33	11 - 28	25	70	48	48	44	6	55,5	82



Manicotti ad innesto rapido
Quick connection sleeves

Codice Code	Manicotto Sleeve	ØD	ØD1	ØD3	L	L1	L2	G
227309	AIRFA. 12	24	12	20	22	48	9	M5
227310	AIRFA. 16	30	16	25	34	64	9,5	M6
227311	AIRFA. 20	38	20	32	34	70	11	M6
227312	AIRFA. 25	45	25	37	38	76	12	M8
227313	AIRFA. 28	48	28	40	38	78	12	M8
227314	AIRFA. 32	55	32	45	45	89	14	M8
227315	AIRFA. 36	60	36	50	45	97	16	M8
227316	AIRFA. 48	80	48	67	57	122	20	M10

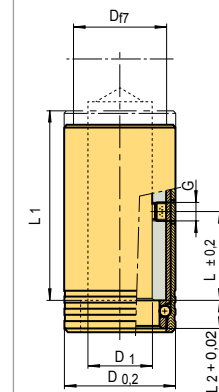

Manicotti ad innesto rapido
Quick connection sleeves

Codice Code	Manicotto Sleeve	ØD	ØD1	ØD3	ØD4	L	L1	L2	G
227350	AIRFCA. 16	27	16	25	22	8	30	9,5	M5
227351	AIRFCA. 20	34	20	32	28	8	30	11	M5
227352	AIRFCA. 25	41	25	37	34,5	8	32	12	M6
227353	AIRFCA. 28	44	28	40	37	8	32	12	M6
227354	AIRFCA. 32	49	32	45	41	9	39	13,5	M6
227355	AIRFCA. 36	55	36	50	46	9	39	16	M6
227356	AIRFCA. 48	73	48	67	61	11	51	20	M8

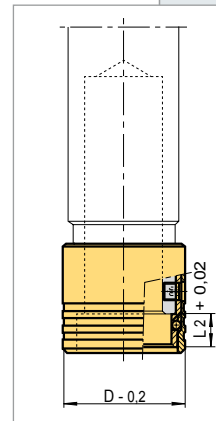

Ghiere ad innesto rapido
Ring nuts

Codice Code	Ghiera Nut	ØD	ØD2	L2	L3
227367	GIRF. 12	21,5	16,4	9	9
227368	GIRF. 16	26	19,9	9,5	9
227369	GIRF. 20	33	25,4	11	9
227370	GIRF. 25	40	31,9	12	10
227371	GIRF. 28	42	33,9	12	10
227372	GIRF. 32	47	37,9	13,5	10
227373	GIRF. 36	54	43,4	16	10
227374	GIRF. 48	72	57,9	20	14

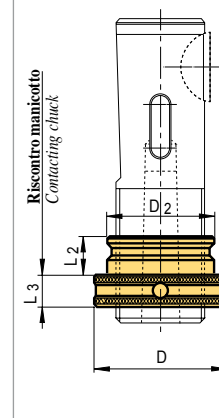

Trascinatori a cono Morse
Morse taper with driving dog

Codice Code	Cono Morse Morse taper	A	B	L1	L2	L3	D1	D2	D3	R	β
011120	2	8	6,3	93	83	16	17,78	28	13,5	6	1°25'50"
011125	3	8	7,9	112	102	20	23,825	30	18,5	7	1°26'16"
011130	4	8	11,9	135,5	125,5	24	31,267	42	24,5	8	1°29'15"
011135	5	8	15,9	167,5	157,5	29	44,399	50	35,7	10	1°30'26"
011136	6	8	19	228	218	40	63,348	62	51	13	1°29'

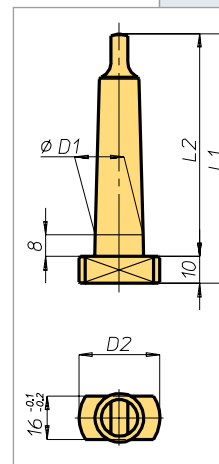

FH

BAH

TA.CP

TA

MOX

HT

VH

TSI/TSX

T

MT-TC-TC3

Accessori Accessories

Appendice tecnica Technical supplement