



# ***Katalog*** **Catalogue**

DE-EN-ID TC.1





STAP

DC

DC

DC

DC

180/41 C11880  
180/60 C11830

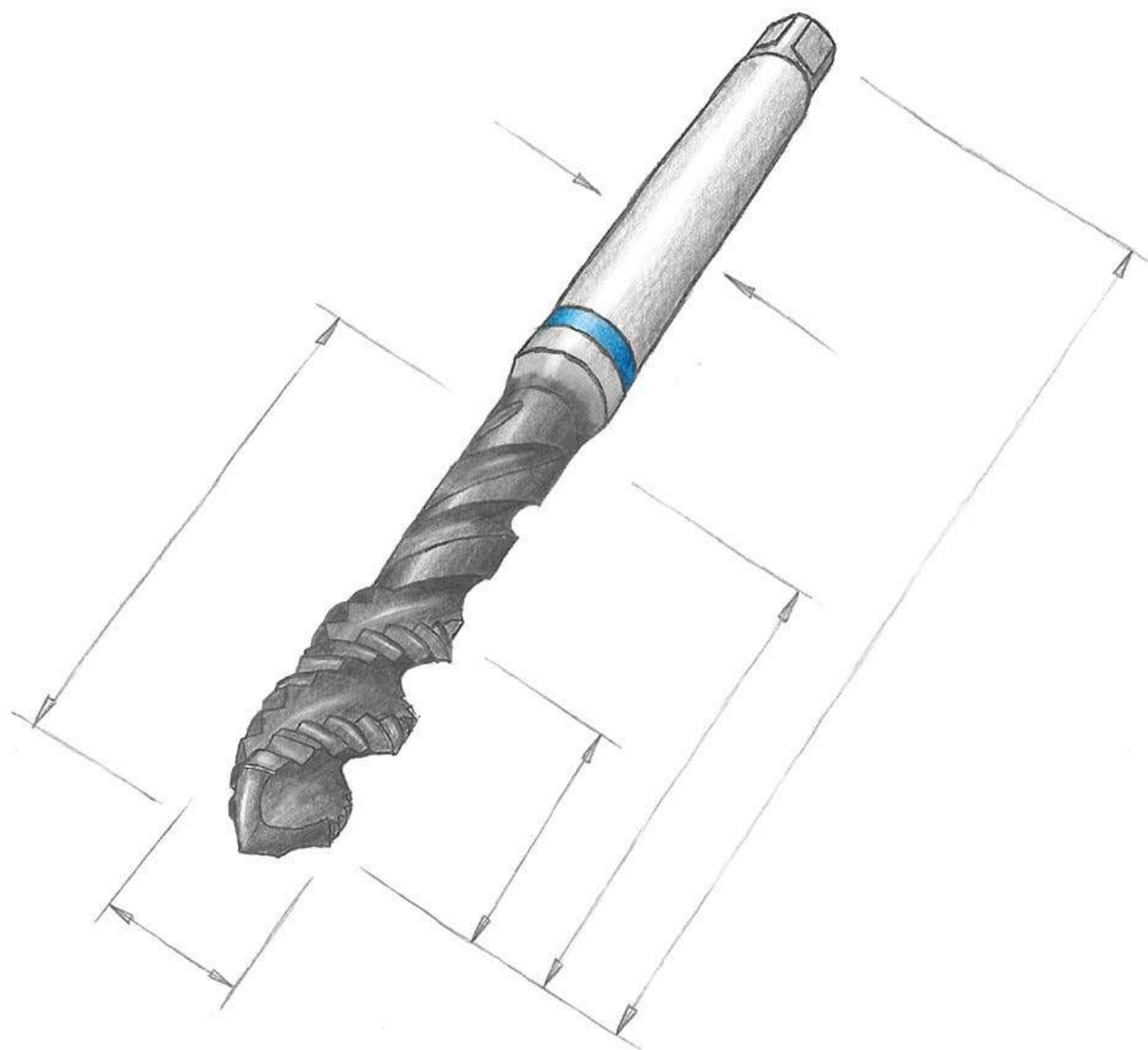





## VERFÜGBARKEIT DER ARTIKEL

- ID Lagerartikel
- ID Kurzfristig lieferbar
- \* ID Ab Lager lieferbar solange Vorrat

## AVAILABILITY OF THE ARTICLES

- ID Stock item
- ID Available at short notice
- \* ID Available from stock, while stock lasts





Unser innovatives KMU ist im Berner Jura in der Schweiz zu Hause, idyllisch eingebettet zwischen Hügeln und am Ufer der hier noch jungen Birs gelegen. Hier werden bereits seit 1940 die Hochleistungs-Gewindewerkzeuge unserer Marke DC entwickelt, produziert und in die ganze Welt geliefert.

Seit der Gründung unseres Unternehmens konzentrieren wir uns auf die Erweiterung unseres Angebotes an Gewindebohrern und Gewindeformern aus HSSE / HSSE-PM, um die Bedürfnisse unserer Kunden optimal zu erfüllen, und auf die Entwicklung neuer Werkzeugtypen für die neusten Technologien und Werkstoffe.

Im Jahre 2000 haben wir den neuen Produktionsbereich „ONE STEP“, ausgestattet mit modernsten Produktionstechnologien, für die Entwicklung und Herstellung von zuverlässigen und leistungsstarken Vollhartmetall-Gewindefräsern geschaffen. In der Zwischenzeit wurde unser VHM-Programm stark weiterentwickelt und ausgebaut, mit Schwerpunkt auf Gewindewirblern.

Seit 2010 wird der Entwicklung unserer Mikrowerkzeuge besonders viel Aufmerksamkeit gewidmet. Das Resultat ist unser in der Zwischenzeit echt breites „nano“-Programm, das Gewindewirbler, Gewindebohrer, Gewindeformer, Gewindelehren und Prüfgewindelehren im Durchmesserbereich von 0.3 – 2.75 mm beinhaltet. Als ISO 17025:2017 akkreditiertes Unternehmen ist die DC Nano Tools SA Ihr Spezialist für diesen Bereich.

Heute werden unsere Hochleistungs-Gewindewerkzeuge weltweit und in sämtlichen Branchen dort eingesetzt, wo Wert auf **Qualität, Leistung** und **Zuverlässigkeit** der Produkte gelegt wird.

Falls Sie in unserem breit gefächerten Standardprogramm nicht finden sollten was Sie benötigen, ändern wir Werkzeuge Ihren Bedürfnissen entsprechend ab oder stellen spezifische Sonderwerkzeuge basierend auf Ihren Vorgaben und Zeichnungen für Sie her.

Für Fragen, auf die Sie in unserem Katalog keine Antwort finden, stehen wir Ihnen selbstverständlich gerne zur Verfügung.



*„Zuerst war ich auf der Suche nach den besten Werkzeugen, dann entschied ich mich, diese selbst herzustellen“*

Daniel Charpillot – 1940



Our innovative SME is at home in the Berner Jura in Switzerland, idyllically nestled between hills and on the banks of the still young river called Birs. This is where since 1940 the high-performance threading tools of our brand DC are developed, manufactured and supplied all over the world.

Since the foundation of our company, we have focused on expanding our range of HSSE / HSSE-PM taps and thread formers in order to optimally meet our customers' needs and on constantly developing new tool types for the latest technologies and materials.

In 2000, we created the new "ONE STEP" production division, equipped with the latest production technologies, for the development and manufacture of reliable and powerful solid carbide thread milling cutters. In the meantime, our CAR programme has been greatly developed and expanded, with a focus on thread whirling cutters.

Since 2010, special attention has been paid to the development of our micro tools. The result is our in the meantime really broad "nano" programme, which includes thread whirlers, taps, thread formers, thread gauges and check thread gauges in the diameter range from 0.3 - 2.75 mm. As an ISO 17025:2017 accredited company, DC Nano Tools SA is your specialist in this field.

Today, our high performance threading tools are used worldwide and in all industries where **quality, performance** and **reliability** of the products are paramount.

If you do not find what you need in our wide range of standard products, we can modify tools to suit your needs or manufacture specific special items, based on your specifications and drawings.

For questions, to which you cannot find an answer in our catalogue, we are of course gladly at your entire disposal.



*"In the beginning, I was looking for the best tools, then I decided to produce them myself"*

Daniel Charpilloz – 1940

# DC SWISS WELTWEIT

UND IMMER IN IHRER NÄHE

## KUNDENNÄHE

Sie finden immer einen kompetenten Ansprechpartner, egal ob im Mutterwerk in der Schweiz, bei einer unserer Tochtergesellschaften in Deutschland, Italien und England, oder bei einer unserer vielen Vertretungen bzw. einem unserer Stützpunkthändler weltweit.

## CUSTOMER PROXIMITY

You will always find a competent contact person, whether at our main site in Switzerland, at one of our subsidiaries in Germany, Italy and England, or at one of our many representatives or resellers worldwide.

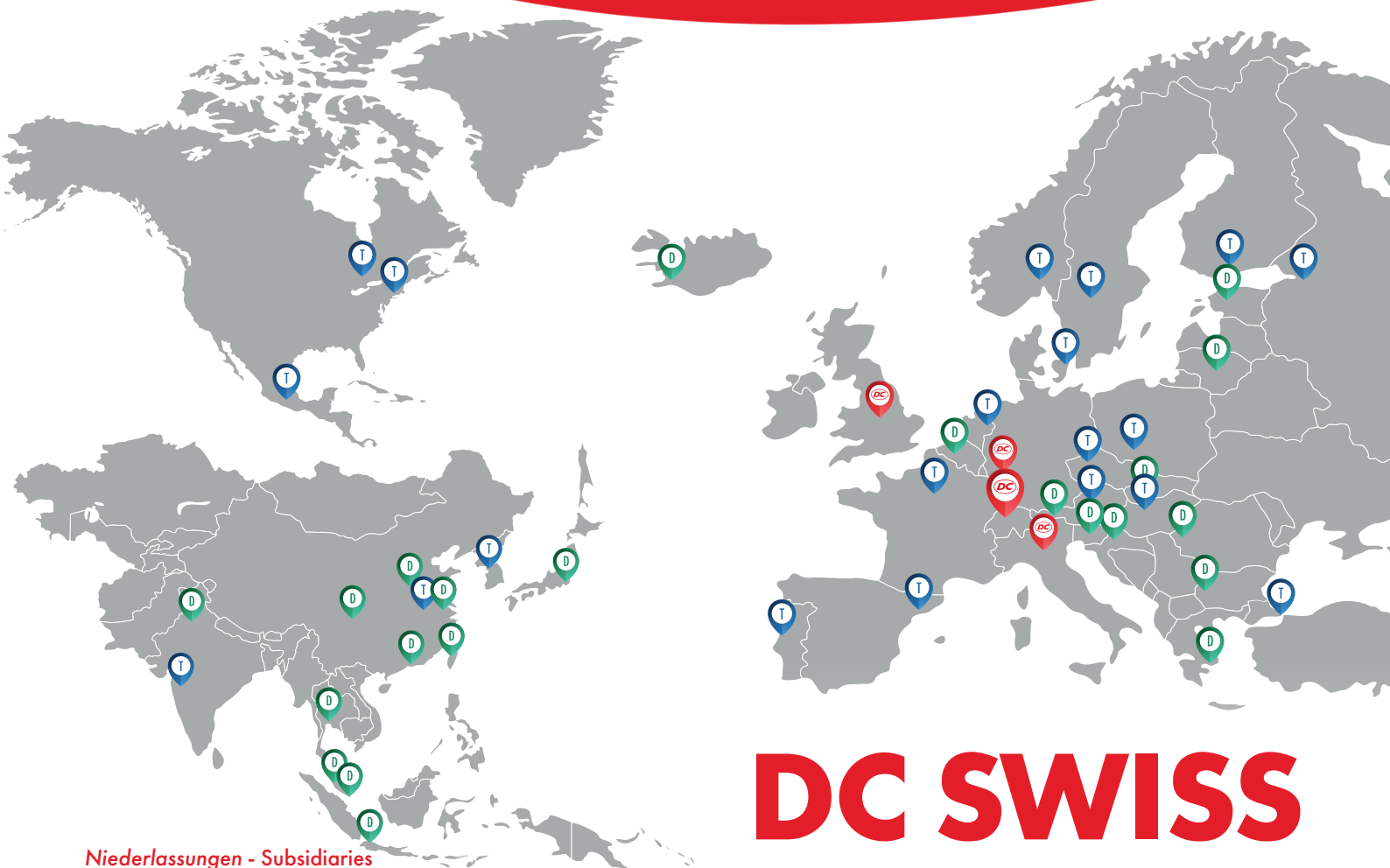

Niederlassungen - Subsidiaries

Technologiepartner - Technology Partners

Vertretungen - Distributors

# DC SWISS WORLDWIDE

Für weitere Länder: [dcswiss.com/de/verkaufsnetz](https://dcswiss.com/de/verkaufsnetz)  
For further countries: [dcswiss.com/en/sales-network](https://dcswiss.com/en/sales-network)

AND ALWAYS CLOSE TO YOU



# SWISS QUALITY



**100 % made by DC SWISS** -  
garantiert von der Entwicklung des  
Werkzeuges über dessen Herstellung bis  
zur Endkontrolle, dank unseres Fachwissens  
und unserer Kompetenz in allen Bereichen der  
Gewindewerkzeugeherstellung.

**100 % made by DC SWISS** - guaranteed from  
the development of the tool to its production and  
straight through to the end control, thanks to our know-  
how and competencies in the whole field of threading tool  
manufacturing.



# UNSERE WERTE

## LEISTUNG

Wir sind darin bestrebt, neue leistungsstarke Gewindewerkzeuge zu entwickeln und die Leistungsfähigkeit unserer Standardprodukte den aktuellen Bedürfnissen unserer Kunden anzupassen. Wir legen grossen Wert auf ein konstantes Preis- / Leistungsverhältnis, als Basis für eine vertrauensvolle Beziehung zu unseren Kunden.

# OUR VALUES

## PERFORMANCE

We make every effort to develop new high-performance threading tools and to adapt the performance of our standard tools to the current needs of our customers. We attach great importance to a constant price/performance ratio as the basis for a trusting relationship with our customers.



**AUTOMOTIVE**  
**AUTOMOTIVE**

**UHRENINDUSTRIE**  
**WATCHMAKING**

**LUFT- UND RAUMFAHRT**  
**AEROSPACE**

**MEDIZINTECHNIK**  
**MEDICAL**

**SONDERLÖSUNGEN**  
**CUSTOMISED SOLUTIONS**



## FACHKENNTNIS

Der Wert unserer Fachkenntnisse zeigt sich in unserer einzigartigen Art und Weise der Problemlösung, indem wir unser seit 1940 angesammeltes Fachwissen, unsere Erfahrungen und Kompetenzen zum Ausdruck bringen, diese miteinander verbinden und umsetzen.

## KNOW-HOW

The value of our know-how represents in a unique way the solving of problems and articulates, implements and associates the whole knowledge, experiences and competences accumulated since 1940.

## ZUVERLÄSSIGKEIT

Wir wissen, dass sich dauerhafte Beziehungen nur auf einem soliden Vertrauensverhältnis aufbauen lassen, basierend auf Transparenz und dem täglichen Engagement jedes einzelnen Mitarbeiters, unseren Kunden Werkzeuge und Dienstleistungen bester Qualität zu liefern.

## RELIABILITY

We know that lasting relationships can only be built on the basic of confidence, transparency and the daily efforts of each of our employees to provide our customers with tools and services of an excellent quality.





# FIRMENPROFIL

## AUSBILDUNGSBETRIEB

Die DC SWISS SA engagiert sich aktiv in der Ausbildung von Jugendlichen und der Weiterbildung bereits erfahrener Fachkräfte. Als Inhaber des Labels **"Ausbildungsbetrieb"** ist es für uns eine Ehrensache, jedes Jahr neue Lehrlinge auszubilden.

Es ist uns wichtig, die nächste Generation von Fachkräften zu sichern und ihr die Möglichkeiten zur Entwicklung und Weiterbildung in einem Bereich mit hohem Potenzial zu bieten.



# COMPANY PROFILE

## TRAINING COMPANY

DC SWISS SA is actively involved in the training of young people and the further education of already experienced professionals. As holder of the **"Training company"** label, it is a matter of honour for us to train new apprentices every year.

It is important to us to ensure the next generation of professionals and to offer them opportunities for development and further training in a field with high potential.



Filière  
de formation  
**POLYMÉCANICIEN**

Wir sind auch Mitglied des Polymechaniker-Lehrprogramms; einem Netzwerk bestehend aus 6 Unternehmen, dessen Ziel es ist, Polymechaniker-Lehrlinge auszubilden.

We are also a member of the polymechanic apprenticeship programme; a network of 6 companies whose aim is to train polymechanic apprentices.



Polymechaniker(in) EFZ - Polymechanic FCC  
Produktionsmechaniker(in) EFZ - Production mechanic FCC  
Disponent(in) EFZ - Logistics specialist FCC  
Kaufmännische(r) Angestellte(r) EFZ - Commercial employee FCC

EFZ = Eidgenössisches Fähigkeitszeugnis  
FCC = Federal Certificate of Competence



**Reduzierung unserer CO<sub>2</sub>-Emissionen**  
und Verbesserung unserer Energieeffizienz

**Reducing our CO<sub>2</sub> emissions**  
and improving our energy efficiency



Wir bevorzugen die Verwendung von **recycelten**  
**oder wiederverwertbaren Materialien**

We favour the use of **recycled**  
**or recyclable materials**



**Unseren Abfall sortieren**  
**Sorting our waste**



## UMWELTSCHUTZ

Wir setzen uns aktiv für den Schutz der Umwelt und des Klimas ein, reduzieren unseren Wasser- und Stromverbrauch und begrenzen die Geschäftsreisen unserer Mitarbeiter auf das Nötigste. Dabei gehen wir höchst verantwortungsvoll mit den Ressourcen um.

## PROTECTION OF THE ENVIRONMENT

We are actively committed to protecting the environment and the climate, to reducing our consumption of water and electricity and to limiting the business travel of our employees to the bare essentials. In doing so, we use resources in a highly responsible manner.



**Wussten Sie, dass** die DC SWISS SA ein Abkommen mit der Energieagentur der Wirtschaft und der Schweizerischen Eidgenossenschaft abgeschlossen hat?

**Did you know that** DC SWISS SA has concluded an agreement with the Energy Agency for the Economy and the Swiss Confederation?





**GEWINDESCHNEIDEN**  
**THREAD CUTTING**



**GEWINDEFORMEN**  
**THREAD FORMING**



**LUFT- UND RAUMFAHRT**  
**AEROSPACE**



**GEWINDEFRÄSEN**  
**THREAD MILLING**



**AUTOMOTIVE**  
**AUTOMOTIVE**



**MEDIZINTECHNIK**  
**MEDICAL**



**SONDERLÖSUNGEN**  
**CUSTOMISED SOLUTIONS**



**ENERGIEERZEUGUNG**  
**POWER GENERATION**



**UHRENINDUSTRIE**  
**WATCHMAKING**



**ALLGEMEINER MASCHINENBAU**  
**GENERAL ENGINEERING**

**GEWINDEWIRBELN**  
**THREAD WHIRLING**



**GEWINDELEHREN**  
**THREAD GAUGES**



**GEWINDESCHNEIDFUTTER**  
**TAPPING CHUCKS**



**GEWINDESCHNEIDEISEN**  
**DIES**



# UNSERE KOMPETENZEN

## KALIBRIEREN & MESSEN

**DC SWISS besitzt eine eigene messtechnische Abteilung, die von der Schweizerischen Akkreditierungsstelle (SAS) als Kalibrierlaboratorium für die Messgrösse "Länge" zugelassen ist.**

DC SWISS kann daher Dienstleistungen im Bereich Kalibrieren und Messen von Gewindeverbindungen anbieten.

Ein Zertifikat ist ein schriftlicher Nachweis über die Qualität der messtechnischen Ausrüstung des Unternehmens. Als Mitglied der DC SWISS Holding bietet Ihnen DC NANO TOOLS SA (Akkreditierung SCS 0143) die Prüfung und Kalibrierung von Gewindelehndornen und Gewindelehrringen nach der internationalen Norm ISO 17025 an.

Unsere Werkzeuge sind das Ergebnis zahlreicher Studien, hoher Fachkompetenzen und langjähriger Erfahrung. Sie werden von uns kontinuierlich bis an ihre Leistungsgrenzen getestet. Dieses Know-how stellen wir Ihnen mit unseren Dienstleistungen zur Verfügung, damit Sie die beste Lösung für Ihre Anwendung erhalten – von der ersten Studie an bis zur Serienfertigung.

Wir beherrschen sämtliche Aspekte der Gewindeschneidtechnologie und stellen Ihnen gerne unsere umfassende Erfahrung auf diesem Gebiet zur Verfügung, sei es bei der Konstruktion, der Fertigung oder der messtechnischen Kontrolle auf den einzelnen Stufen des Fertigungsprozesses.

### **Konstruktion**

Jede Konstruktion ist einzigartig. Für ihre Realisierung gibt es allerdings oft mehrere Lösungen. Wir beraten Sie bei der Auswahl der geeigneten Gewindeverbindung, unter anderem zum Einsatz einstellbarer Schrauben oder hochwertiger selbstsichernder Gewinde. Gemeinsam mit Ihren Konstrukteuren finden wir die für Ihr Projekt bestmögliche Lösung, die wichtige Aspekte wie Masse, Machbarkeit, Produktions- und Montagekosten berücksichtigt.

### **Fertigung**

Jedes Gewindewerkzeug erfordert eine spezifische Programmierung unter Berücksichtigung zahlreicher Parameter. Wir helfen Ihnen bei der individuellen Einstellung Ihrer Maschinen und Werkzeuge, damit Sie optimale Fertigungsergebnisse erzielen können. Wir unterstützen Sie bei den erforderlichen Prüfungen und Messungen, sodass Sie sicher sein können, dass Ihre Gewinde exakt den Vorgaben entsprechen. Auch die perfekte Anpassung des Werkzeuges an Ihre Anforderungen ist für uns selbstverständlich. Probleme bei komplexen Geometrien oder atypischen Positionierungen lassen sich oft mit einer speziellen Werkzeugaufnahme lösen.

### **Messtechnik**

Wir bieten Ihnen nicht nur eine umfangreiche Palette an Messlehren, sondern zeigen Ihnen auch, wie man sie korrekt verwendet und vor allem überprüft, um dauerhaft erstklassige Fertigungsergebnisse zu erzielen. Auch spezifischere Messinstrumente sind erhältlich, etwa zur Überprüfung des Rundlaufs, wie auch alle Zertifizierungen. Wir unterstützen Sie bei der Einrichtung Ihrer Prüfverfahren. Dieser kostenpflichtige Service ist für Flankendurchmesser von 0.1 bis 3.0 mm und für Aussendurchmesser von 0.1 bis 3.5 mm verfügbar. Gehen Sie keine Risiken ein, sondern nutzen Sie die Kompetenzen von DC NANO TOOLS SA für das Kalibrieren Ihrer Messinstrumente.

### **Aus- und Weiterbildung**

In unserem Anwendungszentrum und unserem Labor bieten wir allen Kunden Einführungen in die Theorie und beste Praxis der Gewindeschneidtechnologie an – von der Konstruktion über die Fertigung bis zum Einsatz von Gewindeverbindungen. Auf Wunsch vertiefen wir diese Informationen in spezifischen Schulungen zu bestimmten Themen, wie beispielsweise die Sicherung von Gewindeverbindungen.



# OUR EXPERTISE

## CALIBRATION & METROLOGY SERVICE

**DC SWISS has a metrology lab that is accredited by the Swiss Accreditation Service as a laboratory for calibrating lengths.**

DC SWISS is able to offer a calibration and metrology service for screw connections.

A certificate is written confirmation of the quality of a company's metrological equipment. DC NANO TOOLS SA (SCS accreditation 0143), a member of the DC SWISS Group, can inspect and calibrate thread plug gauges as well as thread ring gauges in accordance with the ISO 17025 international standard.

Our tools are the result of numerous studies. We design them using all the knowledge we have acquired over many years, always testing them to their utmost limits. We share all this knowledge with you in the form of our services. Our aim is to provide the most appropriate solution in each case, from feasibility study right through to mass production.

We are experts in all aspects of the process of screw threading, and are able to offer you our assembly expertise from design, machining and metrological inspection through the various stages of creating screw connections.

### Design expertise

Each design is unique, but there are often multiple solutions. We can advise you on which type of screw fixing to choose, for example adjustable, self-locking or high-quality screws. During the design phase, we can help your designers to identify and decide the best-performing screw fixing in terms of dimensions, practicality, production costs and assembly.

### Machining expertise

Each tool calls for special programming involving numerous parameters. We can help you to get the best out of your machines and tools in order to achieve maximum performance via personalised programming. We can provide you with support in the inspection and measurement phase, so you can be sure of having produced the screw thread you were expecting. And if a tool needs to be customised, we can do this so that it meets all your requirements. Often, a particular approach to fitting makes it possible to resolve a problem caused by complex geometry or unusual positioning.

### Metrological expertise

We supply a large number of measuring gauges and also advice on how to use and inspect them in order to ensure the required quality is consistently achieved. Other more specific measures are available, such as concentricity and certification measures. We can assist you in setting up control procedures. This service is available for pitch diameters of 0.1 to 3.0 mm, and external diameters of 0.1 to 3.5 mm. Don't take the risk – benefit from the expertise of DC NANO TOOLS SA to calibrate your measuring tools.

### Training

In our application centre and our laboratory, we distribute full information and advice on best practice to all our customers in the design, manufacture and use of screw fixings. We can provide on-demand training in specific subjects such as secure fixings.





# FIRMENPROFIL

## ISO 9001-ZERTIFIZIERUNG

Alle Bereiche des Unternehmens sind seit 2006 nach ISO 9001 zertifiziert.



# COMPANY PROFILE

## ISO 9001 CERTIFICATION

All areas of the company have been ISO 9001 certified since 2006.

- ✓ *Kontinuierliche Verbesserung der Kundenzufriedenheit und Kundenbindung.*  
Continuous improvement of customer satisfaction and loyalty.
- ✓ *Erfüllung von Produktstandards in unseren Prozessen und Verfahren und deren Optimierung.*  
Adherence to product standards in our processes and procedures and their optimisation.
- ✓ *Reduzierung der qualitätsbedingten Kosten (Ausschuss, Korrektur, ...).*  
Reduction of quality-related costs (rejects, retouching, etc.).
- ✓ *Verbesserung der organisatorischen und strukturellen Effizienz.*  
Improvement of organisational and structural efficiency.
- ✓ *Erhöhte Fähigkeit zur Anpassung an Veränderungen.*  
Increased ability to adapt to change.
- ✓ *Einbeziehung des Personals in den kontinuierlichen Verbesserungsprozess.*  
Involving staff in the continuous improvement process.



The management system of

## DC Swiss SA

CP 363,  
Grand rue 19  
CH - 2735 Malleray



has been assessed and certified as meeting the requirements of

## ISO 9001:2015

For the following activities

**Design, development, manufacturing, marketing, sales and distribution  
of cutting tools. Expertise in threading technology.**

This certificate is valid from 19 June 2018 until 18 June 2021  
and remains valid subject to satisfactory surveillance audits  
Recertification audit due before 7 June 2021  
Issue 6. Certified since September 2007

Authorised by



SGS Société Générale de Surveillance SA  
Technoparkstrasse 1 8005 Zurich Switzerland  
t +41 (0)44 445-16-80 f +41 (0)44 445-16-88 www.sgs.com



# ALLGEMEINE BAUMASSE NACH ISO / DIN

## GENERAL DIMENSIONS ACCORDING TO ISO / DIN



**N1120-4 ISO 529**

Kurzer, verstärkter ISO-Schaft — Short, reinforced ISO shank



**N1220-4 ISO 529**

Kurzer, durchfallender ISO-Schaft — Short, reduced ISO shank



**N320-4 DIN 371**

Verstärkter DIN-Schaft — Reinforced DIN shank



**N420-4 DIN 376 / DIN 374**

Durchfallender DIN-Schaft — Reduced DIN shank



**N520-4 NORM DC**

Extra-langer Maschinengewindebohrer mit verstärktem DIN-Schaft; Totallänge gemäss DC-Werksnorm — Extra long machine tap with reinforced DIN shank; total length as per DC standards



**N620-4 NORM DC**

Extra-langer Maschinengewindebohrer mit durchfallendem DIN-Schaft; Totallänge gemäss DC-Werksnorm — Extra long machine tap with reduced DIN shank; total length as per DC standards

# BAUMASSE DES GEWINDEBOHRERS — MEASUREMENTS OF THE TAP

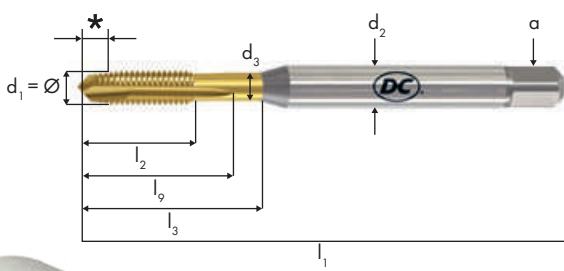

<b>*</b>	<i>Anschnittlänge</i>	Chamfer lead length
<b>d<sub>1</sub></b>	<i>Gewindenenddurchmesser</i>	Nominal thread diameter
<b>d<sub>2</sub></b>	<i>Schaftdurchmesser</i>	Shank diameter
<b>d<sub>3</sub></b>	<i>Halsdurchmesser</i>	Neck diameter
<b>l<sub>1</sub></b>	<i>Totallänge</i>	Overall length
<b>l<sub>2</sub></b>	<i>Gewindelänge</i>	Thread length
<b>l<sub>3</sub></b>	<i>Nutzlänge</i>	Usable length
<b>l<sub>φ</sub></b>	<i>Nutenlänge</i>	Flute length
<b>a</b>	<i>Vierkant</i>	Square
<b>Z</b>	<i>Nutenzahl</i>	Number of flutes

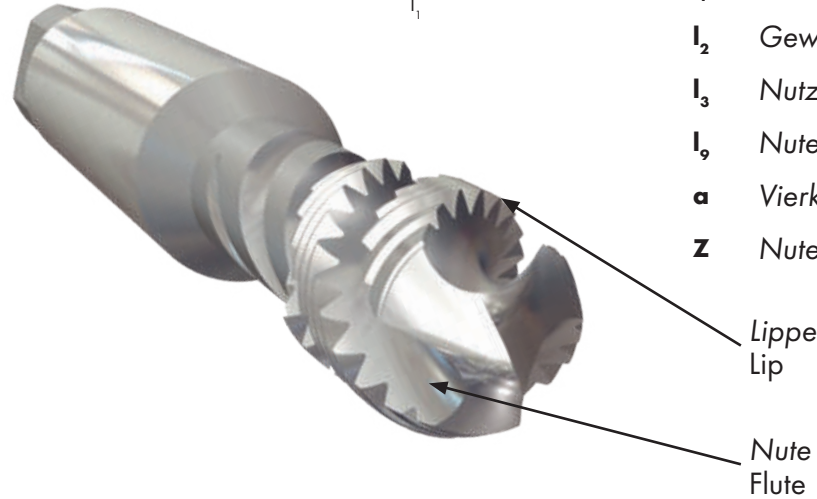

# ZENTRIERSPITZEN — CENTER POINTS

	<b>Gewinde</b>	<b>Thread</b>
	Volle Zentrierspitze	Full external center point
	Abgesetzte Spitze	Reduced center point
	Zentrierbohrung	Internal center point
	<b>Schaft</b>	<b>Shank</b>
	Vollspitze	Full external center point
	Zentrierfase	Centering bevel
	Zentrierbohrung	Internal center point







Die Spitzenform ist abhängig vom Gewindedurchmesser, dem Werkzeugtypen und der Maschine, auf welcher die Werkzeuge hergestellt werden.

The center shape depends on the thread diameter, the type of tool and the machine on which the tools are manufactured.



# NUTENFORMEN FÜR DC-GEWINDEBOHRER

## FLUTE FORMS FOR DC TAPS

	<b>Beispiele für Rechtsgewinde</b>	<b>Examples for right-hand threads</b>
	<b>.10</b> <b>Gerade Nuten</b> für Durchgangs- und Sacklöcher in kurzspanende Werkstoffe	<b>Straight flutes</b> for through and blind holes in short-chipping materials
	<b>.20</b> <b>Gerade Nuten mit Schälanschnitt</b> für Durchgangslöcher in langspan- nende Werkstoffe	<b>Straight flutes with spiral point</b> for through holes in long-chip- ping materials
	<b>.30</b> <b>Nur Schälanschnitt</b> für Durchgangslöcher in langspanende Werkstoffe, für Gewindetiefen $\leq 1.5 \times D$ ; Blechbearbeitung	<b>Spiral point only</b> for through holes in long-chip- ping materials, for threading depth $\leq 1.5 \times D$ ; sheet metal working
	<b>.40</b> <b>Spiralnuten mit leichtem Linksdrall</b> für Durchgangslöcher	<b>Slow left-hand spiral flutes</b> for through holes
	<b>.50</b> <b>Spiralnuten mit leichtem Rechtsdrall <math>\leq 27^\circ</math></b> für Durchgangs- und Sacklöcher in kurzspanende Werkstoffe $\leq 2.5 \times D$ bzw. für Sacklöcher in mittel-lang- und langspanende Werkstoffe $\leq 1.5 \times D$	<b><math>\leq 27^\circ</math> slow right-hand spiral flutes</b> for through and blind holes in short-chipping materials $\leq 2.5 \times D$ respectively for blind holes in middle-long and long-chipping materials $\leq 1.5 \times D$
	<b>.60</b> <b>Spiralnuten mit starkem Rechtsdrall <math>&gt; 27^\circ - \leq 40^\circ</math></b> für Sacklöcher in langspanende Werkstoffe $\leq 2.5 \times D$	<b><math>&gt; 27^\circ - \leq 40^\circ</math> fast right-hand spiral flutes</b> for blind holes in long- chipping materials $\leq 2.5 \times D$
	<b>.70</b> <b>Spiralnuten mit starkem Rechtsdrall <math>&gt; 40^\circ</math> (R45)</b> für Sacklöcher in zähe Werkstoffe bis $3 \times D$	<b><math>&gt; 40^\circ</math> fast right-hand spiral flutes (R45)</b> for blind holes up to $3 \times D$ in tough materials

# SCHMIERNUTENFORMEN FÜR DC-GEWINDEFORMER

## LUBRICATION GROOVE FORMS FOR DC THREAD FORMERS



**.80**

*Ohne Schmiernuten*

**Without lubrication grooves**



**.81**

*Mit Schmiernuten*

**With lubrication grooves**



**.84**

***Mit Schmiernuten und Innen-  
kühlung mit seitlich eingelenk-  
tem 45° Schmiermittelaustritt***  
*(Umstellung auf diese neue  
Ausführung im Gange)*

**With lubrication grooves and  
internal cooling channel with  
lateral 45° lubricant outflow**  
*(conversion to this new version in  
progress)*



# ANSCHNITTFORMEN FÜR DC-GEWINDEBOHRER UND GEWINDEFORMER CHAMFER FORMS FOR DC TAPS AND THREAD FORMERS

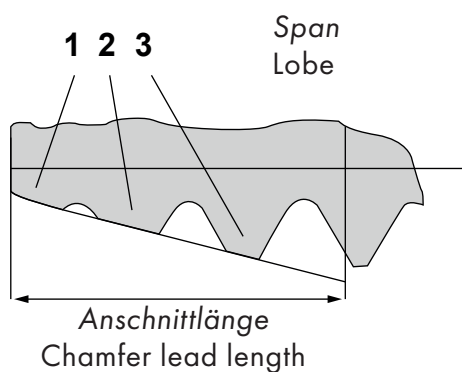

**Spanbildung im Anschnitt**  
**Chip formation in the chamfer**

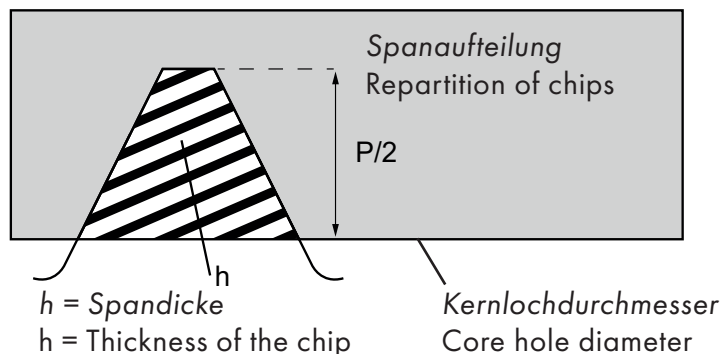

**Chamfer forms and chamfer lead lengths**  
**for taps as per DIN 2197**

**Anschnittformen und Anschrittlängen**  
**für Gewindebohrer nach DIN 2197**

<b>-8</b>			Anschrittlänge 6 - 8 Gewindegänge; für gerade Nuten	Chamfer lead length 6 - 8 threads; for straight flutes
<b>.20 - 4</b>			Anschrittlänge 3.5 - 5.5 Gewindegänge; für gerade Nuten mit Schälanschnitt	Chamfer lead length 3.5 - 5.5 threads; for straight flutes with spiral point
<b>-3</b>			Anschrittlänge 2 - 3 Gewindegänge; für gerade Nuten und Spiralnuten	Chamfer lead length 2 - 3 threads; for straight and spiral flutes
<b>-4</b>			Anschrittlänge 3.5 - 5 Gewindegänge; für gerade Nuten und Spiralnuten	Chamfer lead length 3.5 - 5 threads; for straight and spiral flutes
<b>-5</b>			Anschrittlänge 1.5 - 2 Gewindegänge für gerade Nuten und Spiralnuten	Chamfer lead length 1.5 - 2 threads; for straight and spiral flutes

**Lead taper forms and lead taper lengths**  
**for thread forming taps as per DIN 2175**

**Anformkegelformen und Anformkegellängen**  
**für Gewindeformer nach DIN 2175**

<b>-3</b>			Anformkegellänge 2 - 3 Gewindegänge	Lead taper length 2 - 3 threads
<b>-5</b>			Anformkegellänge 1.5 - 2 Gewindegänge	Lead taper length 1.5 - 2 threads

# DC-SCHNEIDENGEOMETRIEN — DC CUTTING GEOMETRIES

**N**



**Für normale Werkstoffe**  
(Automatenstahl; Baustahl;  
Einsatzstahl; Kohlenstoffstahl;  
Stahl legiert < 850 N/mm<sup>2</sup>; rost-  
freier Stahl, geschwefelt; Kugel-  
graphitguss; Temperguss;  
Messing langspanend;  
Al legiert, Si < 10 %)

**For normal materials**  
(free-cutting steels; structural,  
cementation steels; carbon steels;  
alloy steels < 850 N/mm<sup>2</sup>;  
free machining stainless steels;  
spheroidal graphite + malleable  
cast iron; long chip brass; Al  
alloyed Si < 10 %)

**W**



**Für weiche Werkstoffe**  
(Aluminium unlegiert; niedrig  
legiertes Aluminium;  
Thermoplaste)

**For soft materials**  
(aluminium unalloyed;  
low-alloyed aluminium;  
thermoplastics)

**Z**



**Für zähe Werkstoffe**  
(rost- und säurebeständige  
Werkstoffe - austenitisch; ferritisch,  
martensitisch < 850 N/mm<sup>2</sup>;  
Reintitan; Nickellegierung 1  
< 850 N/mm<sup>2</sup>; Reinkupfer)

**For tough materials**  
(rust and acid resistant mate-  
rials - austenitic stainless steels;  
ferritic and martensitic  
< 850 N/mm<sup>2</sup>; pure titanium;  
nickel alloys 1 < 850 N/mm<sup>2</sup>;  
pure copper)

**ZX  
NEW**



**Für ALU-BRONZE-Legierungen**  
(AMPCO® 21 / 22)

**For ALU-BRONZE-Alloys**  
(AMPCO® 21 / 22)

**H**



**Für hochfeste Werkstoffe**  
> 850 - < 1'400 N/mm<sup>2</sup>  
((legierte Stähle, Vergü-  
tungsstähle - hochfester Stahl);  
**Messing, Bronze, Rotguss**  
(kurzspanend); **Messing bleifrei;**  
**Duroplaste; glasfaserverstärkte**  
**Kunststoffe)**

**For high tensile materials**  
> 850 - < 1'400 N/mm<sup>2</sup>  
((alloyed steels, tempered  
steels - high tensile alloy  
steels); **short chip brass + phos-  
phor bronze + gun metal; lead-  
free brass; duroplastics; glass  
fibre reinforced plastics)**

**S**



**Für sonderlegierte Werkstoffe**  
> 850 - < 1'150 N/mm<sup>2</sup>  
(Stahl legiert / vergütet;  
ferritisch, martensitische Stähle;  
Nickellegierung 2)

**For special alloyed materials**  
> 850 - < 1'150 N/mm<sup>2</sup>  
(alloy steels hardened /  
tempered; ferritic, martensitic  
steels; nickel alloys 2)

**SA AERO**  
SA.20 / SA.50



**Für sonderlegierte Werkstoffe**  
> 850 - < 1'150 N/mm<sup>2</sup>  
(Nickellegierung 2; Messing  
bleifrei)

**For special alloyed materials**  
> 850 - < 1'150 N/mm<sup>2</sup>  
(nickel alloys 2; lead-free brass)



# DC-SCHNEIDENGEOMETRIEN — DC CUTTING GEOMETRIES

**SA AERO**  
SA.90



**Für sonderlegierte Werkstoffe**  
> 1'150 - < 1'600 N/mm<sup>2</sup>  
(Nickellegierung 3)

**For special alloyed materials**  
> 1'150 - < 1'600 N/mm<sup>2</sup>  
(nickel alloys 3)

**TL**



**Für Titanlegierungen**

**For titanium alloys**

**GG**



**Für Grauguss; Alu-Gusse mit hohem Si-Gehalt; Magnesium-Legierungen**

**For grey cast iron; aluminium castings with high Si content; magnesium alloys**

**K**



**Mit spezieller "Spanbrecher-Schneidengeometrie"**  
(für normale, gut zerspanbare Werkstoffe bis 1'150 N/mm<sup>2</sup>; Messing bleifrei)

**With special "chipbreaker cutting edge geometry"**  
(for normal, easily machinable materials up to 1'150 N/mm<sup>2</sup>; lead-free brass)

**QTAP**  
**NEW**



**Der DC-ALLROUNDER**  
(für die Bearbeitung von universellen Werkstoffen bis zu 1'150 N/mm<sup>2</sup>, für den Einsatz im Längenausgleichsfutter und das Synchron-Gewindeschneiden)

**The DC ALLROUNDER**  
(for machining universal materials up to 1'150 N/mm<sup>2</sup>, for use in tapping chucks with axial compensation and for synchronous tapping)

**RTS**



**DC-Synchron-Gewindebohrer Typ RTS**  
(für die Bearbeitung von universellen Werkstoffen bis zu 1'150 N/mm<sup>2</sup>, für das Synchron-Gewindeschneiden "Rigid Tapping")

**DC Synchro tap type RTS**  
(for machining universal materials up to 1'150 N/mm<sup>2</sup>, for synchronous tapping "Rigid Tapping")

**FS**  
< Ø 3 mm



**DC-Gewindeformer Typ FS**  
(Universalgewindeformer mit 4 Druckstellen für kleine Gewinde im Abmessungsbereich Ø ≥ 1 - < 3 mm in alle kaltverformbaren Werkstoffe)

**DC Thread formers type FS**  
(universal thread former with 4 forming lobes for small thread sizes Ø ≥ 1 - < 3 mm, in all cold forming materials)

# DC-SCHNEIDENGEOMETRIEN – DC CUTTING GEOMETRIES

**FPS**  
≥ Ø 3 mm



**DC-Gewindeformer Typ FPS**  
(für Ø ≥ 3 mm, mit breiten Druckstollen, für ein progressives Fließen von Werkstoffen mit geringer Bruchdehnung (Baustähle, Kohlenstoffstähle, legierte Stähle, langspannendes Messing, Aluminium, usw.))

**DC Thread formers type FPS**  
(for Ø ≥ 3 mm, with large forming lobes designed for a progressive flow of materials with low elongation coefficient (structural steels, carbon steels, alloy steels, long chipping brass, aluminium, etc.))

**FAS**  
≥ Ø 3 mm

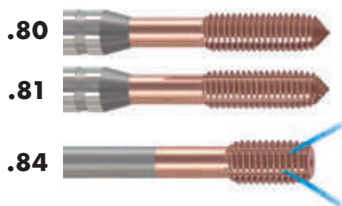

**DC-Gewindeformer Typ FAS**  
(für Ø ≥ 3 mm, mit spitzen Druckstollen, für ein schnelles Fließen von zähen Werkstoffen mit hoher Bruchdehnung (rostfreie Stähle, Reinkupfer, usw.))

**DC Thread formers type FAS**  
(for Ø ≥ 3 mm, with pointed forming lobes designed for a fast flow of tough materials with high elongation coefficient (stainless steels, pure copper, etc.))



**Ausgesetzte Zähne**  
(für weniger Wärmeentwicklung)

**Interrupted thread**  
(for less heat generation)



**Verjüngtes Führungsgewinde**  
(zum Vermeiden von Spanverklebungen und Zahnausbrüchen im Führungsgewinde)

**Truncated thread**  
(to avoid chip jamming and tooth breakage in the guiding section of the tap)



**Verjüngtes Führungsgewinde und Innenkühlung mit stirnseitigem Schmiermittelaustritt**

**Truncated thread and internal coolant with frontal outflow**



# OBERFLÄCHENBEHANDLUNGEN UND BESCHICHTUNGEN

## SURFACE TREATMENTS AND COATINGS



V

### **DC-"V"-Oberflächenbehandlung Dampfangelassen**

Die DC-"V"-Oberflächenbehandlung verbessert die Gleitfähigkeiten der Gewindebohrer und verhindert Kaltschweissungen.

### **DC "V" surface treatment Steam tempered**

The DC "V" surface treatment improves the sliding friction of the tap and prevents cold welding.



NV

**Plasmanitrierung +  
"V"-Oberflächenbehandlung**  
Plasmanitrierte Gewindebohrer haben eine grössere Oberflächenhärte, ca. 1100 HV, und sind besonders geeignet für die Bearbeitung von abrasiven Werkstoffen (Grauguss, Aluguss mit hohem Si-Gehalt). Zudem haben sie eine verbesserte Gleitfähigkeit dank der zusätzlichen DC-"V"-Oberflächenbehandlung.

**Plasma nitriding +  
"V" surface treatment**  
Plasma-nitrided taps have increased surface hardness, approx. 1100 HV, and are particularly suitable for machining abrasive materials (grey cast iron, cast aluminium with high Si content). They also have improved sliding properties thanks to the additional DC "V" surface treatment.



DLC

**DLC-Beschichtung**  
DLC-beschichtete Gewindewerkzeuge haben eine Oberflächenhärte von ca. 2500 HV und eignen sich vor allem für die Bearbeitung von Buntmetallen und Aluminium mit geringem Silizium-Gehalt (< 9 % Si).

**DLC-coating**  
DLC-coated threading tools have a surface hardness of approx. 2500 HV and are particularly suitable for machining non-ferrous metals and aluminium with a low silicon content (< 9 % Si).



TiN

**Titannitrid-Beschichtung (TiN)**  
Die Titannitrid-Beschichtung ist eine Hartstoff-Beschichtung (PVD) mit ca. 2400 HV. TiN-beschichtete Gewindebohrer sind besonders geeignet für die Bearbeitung von abrasiven oder kaltschweisenden Werkstoffen; höhere Schnittgeschwindigkeiten und grössere Leistung.

**Titanium-nitride coating (TiN)**  
The titanium nitride coating is of a hard metal material (PVD) with a hardness of approximately 2400 HV. TiN-coated taps are particularly suitable for working abrasive and cold-welding type materials; higher cutting speeds and improved performance.



TiCN

**Titancarbonitrid-Beschichtung (TiCN)**  
Die TiCN-Beschichtung hat mit ca. 3000 HV eine noch grössere Härte als die TiN-Beschichtung; noch höhere Schnittgeschwindigkeit.

**Titanium-carbonitride coating (TiCN)**  
The TiCN-coating with a hardness of approx. 3000 HV is even harder than the TiN-coating, for even higher cutting speeds.

# OBERFLÄCHENBEHANDLUNGEN UND BESCHICHTUNGEN

## SURFACE TREATMENTS AND COATINGS



VS

### **DC-\"VS\"-Verschleisschutzschicht für den allgemeinen Einsatz**

Spezifische Oberflächen-Behandlung, speziell geeignet für Gewindebohrer der Leistungsklasse "Z", optimal abgestimmt für die Bearbeitung mit Emulsion in INOX; für Gewindebohrer der Leistungsklasse "S" für sonderlegierte Werkstoffe; für Gewindebohrer der Leistungsklasse "TL" für Titan-Legierungen.

### **DC "VS" wear-protective coating for general use**

A special treatment for taps specifically intended for use in Inox with taps of the performance class "Z" with emulsion; in special alloys with taps of the performance class "S"; in titanium alloyed materials with taps of the performance class "TL".



VX

### **DC-\"VX\"-Verschleisschutzschicht für rostfreie Stähle und Nickellegierungen**

Spezifische Oberflächen-Behandlung speziell geeignet für Gewindebohrer der Leistungsklasse "Z", optimal abgestimmt für die Bearbeitung mit Emulsion von rostfreien Stählen und Nickellegierungen.

### **DC "VX" wear-protective coating for stainless steels and Nickel alloys**

Specific surface treatment, especially suitable for taps in performance class "Z", optimally adapted for machining with emulsion of stainless steels and Nickel alloys.

#### **Hinweis**

Unsere Standard-Beschichtungen erlauben die Bearbeitung einer breiten Werkstoffpalette. Für spezifische Anwendungsfälle in ganz bestimmte Werkstoffe bieten wir Ihnen gerne die dafür optimal geeignete Beschichtung an. Lieferfrist und Preis auf Anfrage.

#### **Notice**

Our standard coatings allow a wide range of materials to be performed. For specific applications in very specific materials, we will be pleased to offer you the most suitable coating. Delivery time and price on request.

## AERO



### MJ UNJC - UNJF

S320VS-4



S370VX-3



### MJ UNJC - UNJF

SA320-4



SA350-3



SA390-3



### MJ UNJC - UNJF

TL351VS-3



## ZX



Für ALU-BRONZE-Legierungen (AMPCO® 21/22)  
For ALU-BRONZE-Alloys (AMPCO® 21/22)

### M

ZX320-4

ZX420-4



## QTAP



DC-Allrounder  
DC Allrounder

### M - MF - UNC UNF - G

Q320VS-4 Q420VS-4



Q323VS-4 Q423VS-4

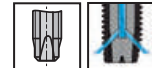

Q360VS-3 Q460VS-3



Q363VS-3 Q463VS-3



## ERWEITERTE DC-ANWENDUNGSTABELLE ENLARGED DC APPLICATION CHART

**\* 17** Stahl vergütet > 44 - ≤ 54 HRC  
Alloy steels tempered > 44 - ≤ 54 HRC  
> 44 - ≤ 54 HRC

**\* 18** Stahl gehärtet > 54 - ≤ 63 HRC  
Alloy steels hardened > 54 - ≤ 63 HRC  
> 54 - ≤ 63 HRC

**64** Messing bleifrei (ECOBASS®)  
Lead free brass (ECOBASS®)

CuZn21Si3P  
(ECOBASS®)  
CuZn35  
CuZn42

\* Siehe unser Programm DC-VHM-Gewindefräser und VHM-Gewindewirbler gemäss DC-Katalog TM.1.  
\* See our programme DC solid carbide thread milling cutters and solid carbide thread whirl cutters as per DC catalogue TM.1.



## RTS



**M**

**7GX**

RTS362VS-3

RTS462VS-3



R40



**VS**

## NP



**M**

NP110-1 NP210-1



NP110-2 -3 NP210-2 -3



## H.TC



**MF - UNC - UNF**

H320TC-4 H420TC-4



**TiCN**

H350TC-3 H450TC-3



R25

**TiCN**

## AUF ANFRAGE

- Für den spezifischen Einsatz gemäss Kundenanforderungen:  
DC-Maschinengewindebohrer Typ MEGA  
(Ø 42 - 164 mm)
- DC-VHM-Maschinen-Gewindebohrer für höhere Standzeiten und grössere Prozesssicherheit in spezifischen Anwendungsfällen.

## ON REQUEST

- For specific applications according to customer requirements:  
DC machine taps type MEGA  
(Ø 42 - 164 mm)
- DC solid carbide machine taps for higher tool-life and improved process security in specific applications.

## TECHNISCHE VERBESSERUNGEN: UMSTELLUNG AUF NEUE AUSFÜHRUNG IM GANGE

## TECHNICAL IMPROVEMENTS: CHANGE TO NEW VERSION IN PROGRESS

### INNENKÜHLUNG MIT SEITLICHEM SCHMIERMITTELAUSTRITT, NEU 45° INTERNAL COOLANT WITH RADIAL OUTFLOW, NEW 45°



RTS323VS-4 RTS423VS-4  
RTS523VS-4 RTS623VS-4  
FPS384VS-3 FPS484VS-3  
FPS584VS-3 FPS684VS-3  
FAS384VS-3 FAS484VS-3  
FAS584VS-3 FAS684VS-3



### MIT NEUER SCHNEIDKANTEN-KONDITIONIERUNG WITH NEW CONDITIONING OF THE CUTTING EDGES



Z370VS-3 Z470VS-3  
Z373VS-3 Z473VS-3



SA320-4 SA420-4  
SA350-3 SA450-3  
SA390-3



TL320VS-4 TL420VS-4  
TL351VS-3 TL451VS-3  
S370VX-3 S470VX-3

#### COMING SOON:

Überarbeitete Gewindebohrer Typ H.20TC-4 / H.50TC-3 - neue VH-Beschichtung zur Erhöhung der Werkzeugstandzeit um bis zu 50 %, für Materialien gemäß den Gruppen 15 und 16 unserer Anwendungstabelle.

#### COMING SOON:

Reworked taps H.20TC-4 / H.50TC-3 - new VH coating to increase tool life by up to 50 %, for materials according to groups 15 and 16 of our application chart.

# NANO GEWINDEBOHRER, GEWINDEFORMER, GEWINDELEHREN NANO TAPS, THREAD FORMERS, THREAD GAUGES

M / MF / UNC / UNF  
S / SF / SL  
Ø 0.3 - Ø 2.74 mm

DZ04



DZ14



DN01



DN02



TAN

TAZ

FA/CFA

CMS





# KODIERUNG – CODIFICATION

**DC**-Gewindebohrer

**DC** Taps

Beispiel - Example



Normale Werkstoffe	Normal materials	<b>N</b>
Weiche Werkstoffe	Soft materials	<b>W</b>
Zähe Werkstoffe	Tough materials	<b>Z</b>
Alu-Bronze-Legierungen	Alu-bronze alloys	<b>ZX</b>
Hochfeste Werkstoffe	High tensile materials	<b>H</b>
Sonderlegierte Werkstoffe	Special alloys	<b>S</b>
Sonderlegierte Werkstoffe (Aero)	Special alloys (Aero)	<b>SA</b>
Titanlegierungen (Aero)	Titanium alloys (Aero)	<b>TL</b>
Grauguss und Alu-Guss	Cast iron and aluminium casting	<b>GG</b>
Allrounder	Allrounder	<b>QTAP</b>
Synchron-Gewindeschneiden	Rigid Tapping	<b>RTS</b>
Spanbrecher	Swarf breaker	<b>K</b>
MEGA-Gewindegrößen	MEGA tap sizes	<b>MA</b>
Spezialausführung	Special execution	<b>3</b>
Kurzer DIN-Schaft verstärkt	DIN short - reinforced shank	<b>1</b>
Kurzer DIN-Schaft durchfallend	DIN short - reduced shank	<b>2</b>
Langer DIN-Schaft verstärkt	DIN long - reinforced shank	<b>3</b>
Langer DIN-Schaft durchfallend	DIN long - reduced shank	<b>4</b>
Extra-langer DIN-Schaft verstärkt	DIN extra-long - reinforced shank	<b>5</b>
Extra-langer DIN-Schaft durchfallend	DIN extra-long - reduced shank	<b>6</b>
DC-Werksnorm	DC standards	<b>9</b>
Kurzer ISO-Schaft verstärkt	ISO short - reinforced shank	<b>11</b>
Kurzer ISO-Schaft durchfallend	ISO short - reduced shank	<b>12</b>
Gerade Nuten	Straight flutes	<b>1</b>
Gerade Nuten und Schälanschnitt	Straight flutes with spiral point	<b>2</b>
Schälanschnitt	Spiral point	<b>3</b>
Spiralnuten mit Linksdraht < 27°	< 27° left-hand slow spiral flutes	<b>4</b>
Spiralnuten mit Rechtsdraht < 27°	< 27° right-hand slow spiral flutes	<b>5</b>
Spiralnuten mit Rechtsdraht > 27°	> 27° right-hand fast spiral flutes	<b>6</b>
Spiralnuten mit Rechtsdraht > 40°	> 40° right-hand fast spiral flutes	<b>7</b>
Spiralnuten mit Rechtsdraht 10°, Schälän.	10° right-hand slow spiral flutes, spiral point	<b>9</b>
Standardausführung	Standard	<b>0</b>
Ausgesetzte Zähne	Interrupted thread	<b>1</b>
Verjüngtes Führungsgewinde	Truncated thread	<b>2</b>
Innenkühlung	Internal coolant	<b>3</b>
Ausgesetzte Zähne, Innenkühlung	Interrupted thread, internal coolant	<b>4</b>
Verjüngtes Führungsgewinde, Innenkühlung	Truncated thread, internal coolant	<b>5</b>
"V"-Oberflächenbehandlung	"V" surface treatment	<b>V</b>
VS-Verschleisschutzschicht, generell	VS wear-protective coating, general	<b>VS</b>
VX-Beschichtung für rostfreie Stähle und Nickelleg.	VX coating for stainless steels and Nickel alloys	<b>VX</b>
Titanitrid-Beschichtung (TiN)	Titanium-nitride coating (TiN)	<b>TN</b>
Titancarbonitrid-Beschichtung (TiCN)	Titanium carbonitride coating (TiCN)	<b>TG</b>
Plasmanitrierung + "V"-Oberflächenbehandlung	Plasma nitriding + "V" surface treatment	<b>NV</b>
DLC-Beschichtung	DLC-coating	<b>DL</b>
Vorschneider	Taper tap	<b>-1</b>
Mittelschneider	Second tap	<b>-2</b>
Fertigschneider / 2 - 3 Gewindegänge	Bottoming tap / 2 - 3 chamfered threads	<b>-3</b>
3.5 - 5.5 Gewindegänge, Schälanschnitt	3.5 - 5.5 chamfered threads, spiral point	<b>-4</b>
1.5 - 2 Gewindegänge	1.5 - 2 chamfered threads	<b>-5</b>
6 - 8 Gewindegänge	6 - 8 chamfered threads	<b>-8</b>
Gewindebohrer-Satz	Thread taps set	<b>-S</b>

# PIKTOGRAMME — PICTOGRAPHS









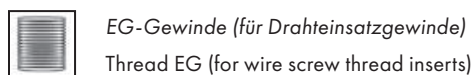
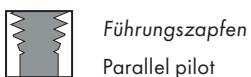
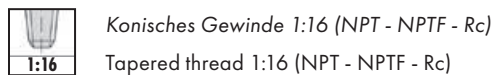
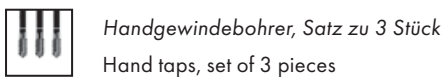
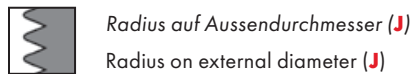
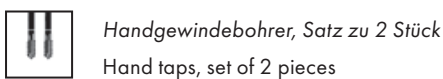
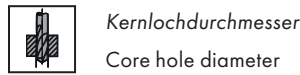
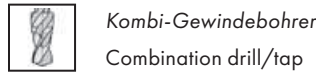
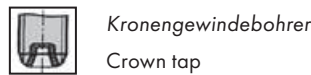
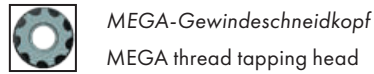
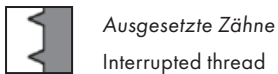
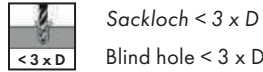
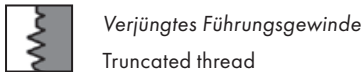
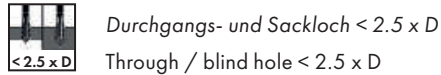
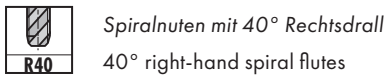
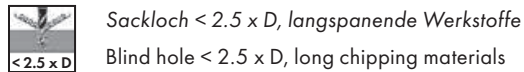
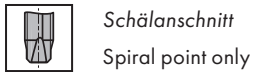
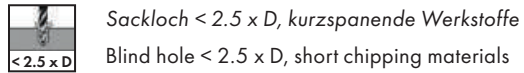
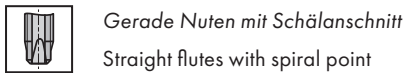
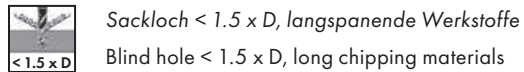
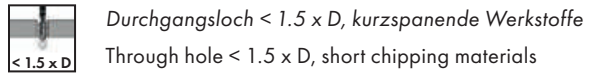
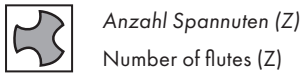
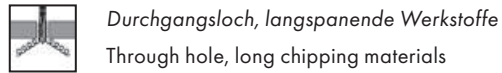
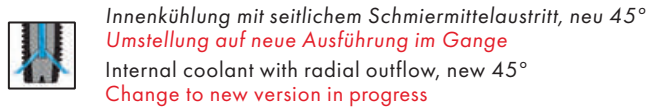
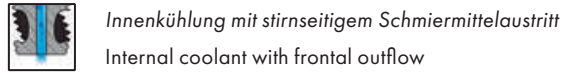
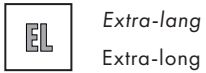
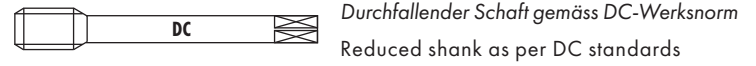
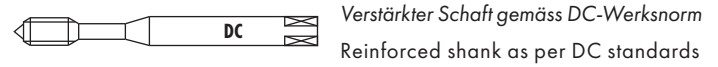









Für Werkstoffgruppen gemäss **DC**-Anwendungstabelle  
 For material groups as per **DC** application chart

<b>12</b>	
1.0037	Si37-2 (S235JR)
1.0050	St50-2 (E295)
1.0060	St60-2 (E335)
1.5919	15CrNi6
1.7131	16MnCr5

<b>22</b>	
1.4301	X5CrNi18-10
1.4406	X2CrNiMoN17-12-2
1.4435	X2CrNiMo18-14-3
1.4541	X6CrNiTi18-10
1.4571	X6CrNiMoTi17-12-2



# PIKTOGRAMME — PICTOGRAPHS

	Linksgewinde Left-hand thread	<span style="color: green;">●</span>	Lagerartikel Stock item
	3.5 - 5.5 Gewindegänge, Anschnitt Form B 3.5 - 5.5 chamfered threads, lead form B	<span style="color: orange;">●</span>	Kurzfristig lieferbar Available at short notice
	2 - 3 Gewindegänge, Anschnitt Form C 2 - 3 chamfered threads, lead form C	*	Ab Lager lieferbar solange Vorrat Available from stock, while stock lasts
	1.5 - 2 Gewindegänge, Anschnitt Form E 1.5 - 2 chamfered threads, lead form E		
	Toleranzklasse ISO 2 6H Tolerance class ISO 2 6H		
	Toleranzklasse ISO 2 6H + 0.1 mm Tolerance class ISO 2 6H + 0.1 mm		
	Toleranzklasse ISO 3 6G Tolerance class ISO 3 6G		
	DC-"V"-Oberflächenbehandlung DC "V" surface treatment		
	DC-"VS"-Verschleisschutzschicht für den allgemeinen Einsatz DC "VS" wear-protective coating for general use		
	DC-"VX"-Verschleisschutzschicht für rostfreie Stähle und Nickellegierungen DC "VX" wear-protective coating for stainless steels and Nickel alloys		
	Titannitrid-Beschichtung Titanium-nitride coating		
	Titancarbonitrid-Beschichtung Titanium-carbonitride coating		
	Plasmanitrierung + "V"-Oberflächenbehandlung Plasma nitriding + "V" surface treatment		
	DLC-Beschichtung DLC-coating		
	Hardlube-Beschichtung Hardlube-coating		
	Spanfragmente / regelmässige Spanaufteilung Swarf fragments / consistant chips		
	Für synchrones Gewindeschneiden For Rigid Tapping		
	Für klassisches Gewindeschneiden For Classic Tapping		



# ANWENDUNGSGRUPPEN

## Beispiele für Anwendungsgruppen

Referenz: DIN

<b>11</b> Automatenstahl 1.0711 9S20 1.0715 9SMn28 1.0718 9SMnPb28 1.0726 35S20 1.0737 9SMnPb36	<b>12</b> Baustahl, Einsatzstahl 1.0037 S137-2 (S235JR) 1.0050 S150-2 (E295) 1.0060 S160-2 (E335) 1.5919 15CrNi6 1.7131 16MnCr5	<b>13</b> Kohlenstoffstahl 1.0503 C45 1.0535 C55 1.0601 C60 1.1545 C105W1 1.2067 102Cr6 (100Cr6)	<b>14</b> Stahl legiert < 850 N/mm <sup>2</sup> 1.2363 X100CrMoV5-1 1.3551 80MoCrV42-16 1.7218 25CrMo4 1.7220 34CrMo4 1.7225 42CrMo4	<b>15</b> Stahl legiert / vergütet > 850 - < 1150 N/mm <sup>2</sup> 1.3553 X82WMoCrV6-5-4 1.6580 30CrNiMo8 1.7220 34CrMo4 1.7225 42CrMo4 1.8507 34CrAlMo5
<b>16</b> Hochfester Stahl ≤ 44 HRC EN-GJS-1200-2 1.6582 34CrNiMo6v 1.7225 42CrMo4v 1.7228 50CrMo4v 1.8515 31CrMo12v	<b>17</b> Stahl vergütet > 44 - ≤ 54 HRC > 44 - ≤ 54 HRC	<b>18</b> Stahl gehärtet > 54 - ≤ 63 HRC > 54 - ≤ 63 HRC	<b>21</b> Rostfreier Stahl, geschwefelt 1.4005 X12CrS13 1.4104 X14CrMoS17 1.4305 X10CrNiS18-9	<b>22</b> Austenitisch 1.4301 X5CrNi18-10 1.4406 X2CrNiMoN17-12-2 1.4435 X2CrNiMo18-14-3 1.4541 X6CrNiTi18-10 1.4571 X6CrNiMoTi17-12-2
<b>23</b> Ferritisch, martensitisch < 850 N/mm <sup>2</sup> 1.4112 X90CrMoV18 1.4540 X4CrNiCuNb16-4 1.4582 X4CrNiMoNb25-7 1.4762 X10CrAl24 1.4922 X20CrMoV11-1	<b>24</b> Ferritisch, martensitisch > 850 - < 1150 N/mm <sup>2</sup> 1.4057 17CrNi16-2 1.4125 X105CrMo17 1.4542 X5CrNiCuNb16-4 1.4548 X5CrNiCuNb17-4-4 1.4748 X85CrMoV18-2	<b>31</b> Grauguss 0.6015 GJL-150 0.6020 GJL-200 0.6025 GJL-250 0.6030 GJL-300	<b>32</b> Kugelgraphitguss, Temperguss 0.7040 GJS 400-15 0.7043 GJS 400-18 0.7050 GJS 500-7 0.7060 GJS 600-3 0.7080 GJS 800-2	<b>41</b> Reintitan 3.7024 Grad1 3.7034 Grad2 3.7055 Grad3 3.7065 Grad4
<b>42</b> Titanlegierung 3.7124 TiCu2.5 TiAl7Nb 3.7164 TiAl6V4 (Grad5) 3.7174 TiAl6V6Sn2	<b>51</b> Nickellegierung 1 ≤ 850 N/mm <sup>2</sup> 1.3912 Ni36 (Invar) 2.4360 NiCu30Fe (Monel 400) 2.4816 NiCr15Fe (Inconel 600) 1.4876 X10NiCrAlTi32-20	<b>52</b> Nickellegierung 2 > 850 - ≤ 1150 N/mm <sup>2</sup> 2.4375 NiCu30Al (MonelK500) 2.4631 NiCr20TiAl (Nimonic 80) NiCr19NbMo (Inconel718) 2.4668	<b>53</b> Nickellegierung 3 > 1150 - ≤ 1600 N/mm <sup>2</sup> 2.4631 NiCr20TiAl (Nimonic80) 2.4668 NiCr19NbMo (Inconel718)	<b>61</b> Reinkupfer (Elektrolytkupfer) 2.0060 E-Cu57 (E-Cu)
<b>62</b> Messing, Bronze, Rotguss (kurzspanend) 2.0401 CuZn39Pb3 (Ms58) 2.0402 CuZn40Pb2 (Ms58) 2.1030 CuSn8 (Bz) 2.1096 G-CuSn5ZnPb	<b>63</b> Messing (langspanend) 2.0240 CuZn15 (Ms85) 2.0265 CuZn30 (Ms70) 2.0321 CuZn37 (Ms63)	<b>64</b> Messing bleifrei CuZn21Si3P (ECOBASS®) CuZn35 CuZn42	<b>71</b> Al unlegiert 3.0205 Al99 3.0255 Al99.5	<b>72</b> Al legiert Si < 1.5 % 3.1255 AlCuSiMn 3.1355 AlCuMg2 3.2315 AlMgSi1 3.3206 AlMgSi0.5 3.4345 AlZnMgCu0.5
<b>73</b> Al legiert Si > 1.5 % - < 10 % 3.2161 G-AlSi8Cu3 3.2162 GD-AlSi8Cu3 3.2341 G-AlSi5Mg 3.2371 G-AlSi7Mg	<b>74</b> Al legiert Si > 10 %, Mg-Legierungen 3.2381 G-AlSi10Mg 3.2382 GD-AlSi10Mg 3.2581 G-AlSi12 3.2583 G-AlSi12 (Cu)	<b>81</b> Thermoplaste Delrin (POM) Teflon Nylon	<b>82</b> Duroplaste Bakelit Novopan	<b>83</b> Faserverstärkte Kunststoffe Glasfaserverstärkte Thermo- und Duroplaste
<b>91</b> Gelbgold 2N18 Au585AgCu205 3N18 Au917AgCu44	<b>92</b> Rotgold 4N18 5N18 Au585CuAg325 Au750AgCu Au917Cu83	<b>93</b> Weissgold Au750PdCu125 Au750PdCu150 Au585PdCu150 Au925Pd75	<b>94</b> Silber Ag999 Ag800Cu Ag925Cu	

# APPLICATION GROUPS

Examples for application groups

Reference:  
AISI/ASTM/UNS

11	Free-cutting steels
1.0711	1212
1.0715	1213
1.0718	12L13
1.0726	1140
1.0737	12L14

12	Structural, cementation steels
1.0037	1015
1.0050	A570 Gr.50
1.0060	A572 Gr.55
1.5919	4617
1.7131	5115

13	Carbon steels
1.0503	1045
1.0535	1055
1.0601	1060
1.1545	W110
1.2067	L 3

14	Alloy steels < 850 N/mm <sup>2</sup>
1.2363	A2
1.3551	M50
1.7218	4130
1.7220	4135
1.7225	4140

15	Alloy steels hard./temp. > 850 - < 1150 N/mm <sup>2</sup>
1.3553	-
1.6580	4340
1.7220	4135
1.7225	4140
1.8507	A355CLD (K23510)

16	High tensile alloy steels ≤ 44 HRC
EN-GJS-1200-2	
1.6582	4340
1.7225	4140
1.7228	4150
1.8515	-

17	Alloy steels tempered > 44 - ≤ 54 HRC
> 44 - ≤ 54 HRC	

18	Alloy steels hardened > 54 - ≤ 63 HRC
> 54 - ≤ 63 HRC	

21	Free machining stainless steels
1.4005	416
1.4104	430F
1.4305	303

22	Austenitic stainless steels
1.4301	304
1.4406	316LN
1.4435	316L
1.4541	321
1.4571	316Ti

23	Ferritic and martensitic < 850 N/mm <sup>2</sup>
1.4112	440B
1.4540	XM12
1.4582	-
1.4762	446
1.4821	4922

24	Ferritic and martensitic > 850 - < 1150 N/mm <sup>2</sup>
1.4057	431
1.4125	440C
1.4542	630 (17-4PH)
1.4748	-

31	Cast iron
0.6015	A48-25B
0.6020	A48-30B
0.6025	A48-35B
0.6030	A48-45B

32	Spheroidal graphite + malleable cast iron
0.7040	65-45-12
0.7043	60-40-18
0.7050	80-55-06
0.7060	70-60-03
0.7080	120-90-02

41	Pure titanium
3.7024	Gr.1
3.7034	Gr.2
3.7055	Gr.3
3.7065	Gr.4

42	Titanium alloys
3.7124	Alloy 230
	F-1295
3.7164	Gr.5
3.7174	-

51	Nickel alloys 1 ≤ 850 N/mm <sup>2</sup>
1.3912	K93600
2.4360	N04400
2.4816	N06600
1.4876	N08800

52	Nickel alloys 2 > 850 - ≤ 1150 N/mm <sup>2</sup>
2.4375	N05500 (B865)
2.4631	N07080 (B637)
2.4668	N07718 (B637)

53	Nickel alloys 3 > 1150 - ≤ 1600 N/mm <sup>2</sup>
2.4631	N07080 (B637)
2.4668	N07718 (B637)

61	Pure copper (electrolytic copper)
2.0060	C11000

62	Short chip brass, phosphor-bronze, gun metal
2.0401	C38500
2.0402	C37800
2.1030	C52100
2.1096	-

63	Long chip brass
2.0240	C23000
2.0265	C26000
2.0321	C27200

64	Lead free brass
CuZn21Si3P (ECOBRESS®)	
CuZn35	
CuZn42	

71	Al unalloyed
3.0205	1200
3.0255	1050A

72	Al alloyed Si < 1.5 %
3.1255	2014
3.1355	2024
3.2315	6082
3.3206	6060
3.4345	7022

73	Al alloyed Si > 1.5 % - < 10 %
3.2161	327
3.2162	-
3.2341	-
3.2371	356

74	Al alloyed Si > 10 %, Mg-alloys
3.2381	A360
3.2382	-
3.2581	A413
3.2583	413.1

81	Thermoplastics
Delrin (POM)	
Teflon	
Nylon	

82	Duroplastics
Bakelit	
Novopan	

83	Glass fibre reinforced plastics
Glass fibre reinforced, Thermo and Duroplastics	

91	Yellow gold
2N18	
Au585AgCu205	
3N18	
Au917AgCu44	

92	Red gold
4N18	
5N18	
Au585CuAg325	
Au750AgCu	
Au917Cu83	

93	White gold
Au750PdCu125	
Au750PdCu150	
Au585PdCu150	
Au925Pd75	

94	Silver
Ag999	
Ag800Cu	
Ag925Cu	

# ANWENDUNGSTABELLE — APPLICATION CHART

## Gewindeschneiden Thread cutting

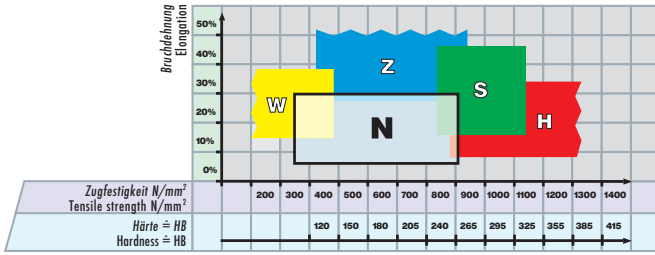

## Gewindeschneiden Thread cutting

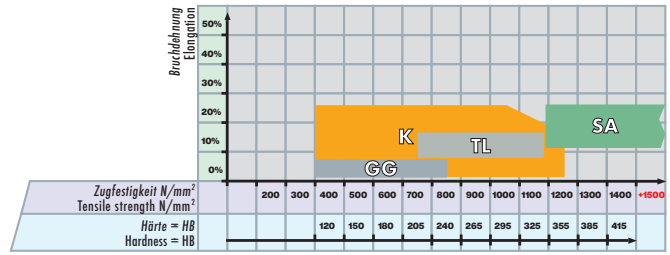

## Gewindeschneiden klassisch und synchron Thread cutting classic and rigid

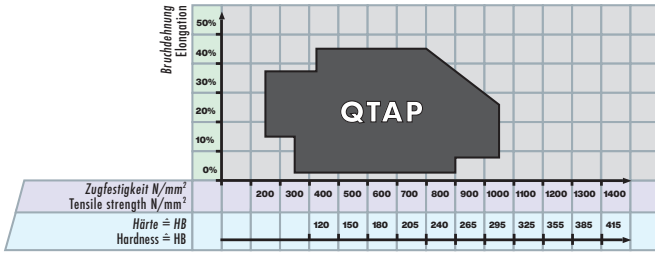

## Synchron-Gewindeschneiden Rigid Tapping

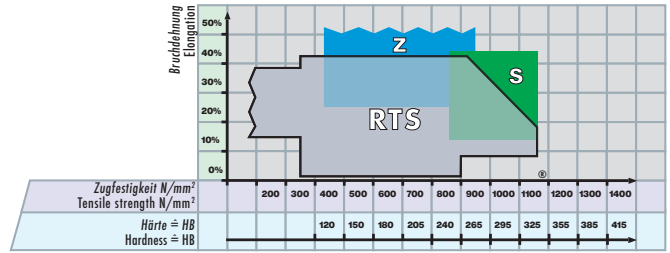

## DC -Anwendungsgruppen

## DC Material classification

Werkstoff-Gruppen Material groups	Werkstoffbezeichnung	Material designation	Härte Hardness (HB)	Festigkeit Tensile strength Rm (N/mm <sup>2</sup> )	Dehnung Elongation A (%)
<b>10</b> Stahl Steels	11 Automatenstahl	Free-cutting steels	< 200	< 700	< 10
	12 Baustahl, Einsatzstahl	Structural, cementation steels	< 200	< 700	< 30
	13 Kohlenstoffstahl	Carbon steels	< 300	< 1000	< 20
	14 Stahl legiert < 850 N/mm <sup>2</sup>	Alloy steels < 850 N/mm <sup>2</sup>	< 250	< 850	< 30
	15 Stahl legiert / vergütet > 850 - < 1150 N/mm <sup>2</sup>	Alloy steels hard./ temp. > 850 - < 1150 N/mm <sup>2</sup>	> 250	> 850	< 30
	16 Hochfester Stahl ≤ 44 HRC	High tensile alloy steels ≤ 44 HRC	> 250	> 850	< 12
	17 Stahl vergütet > 44 - ≤ 54 HRC	Alloy steels tempered > 44 - ≤ 54 HRC	> 410	> 1400	< 2
	18 Stahl gehärtet > 54 - ≤ 63 HRC	Alloy steels hardened > 54 - ≤ 63 HRC	> 560	> 1980	< 2
<b>20</b> Rostfreier Stahl Stainless steels	21 Rostfreier Stahl, geschwefelt	Free machining stainless steels	< 250	< 850	< 25
	22 Austenitisch	Austenitic stainless steels	< 250	< 850	> 20
	23 Ferritisch, martensitisch < 850 N/mm <sup>2</sup>	Ferritic and martensitic < 850 N/mm <sup>2</sup>	< 250	< 850	> 20
	24 Ferritisch, martensitisch > 850 - < 1150 N/mm <sup>2</sup>	Ferritic and martensitic > 850 - < 1150 N/mm <sup>2</sup>	> 250	> 850	> 15
<b>30</b> Guss Cast iron	31 Grauguss	Cast iron	< 250	< 850	< 10
	32 Kugelgraphitguss, Temperguss	Spheroidal graphite + malleable cast iron	< 250	< 850	> 10
<b>40</b> Titan Titanium	41 Reintitan	Pure titanium	< 250	< 850	> 20
	42 Titanlegierung	Titanium alloys	> 250	> 850	< 20
<b>50</b> Nickel Nickel	51 Nickellegierung 1 ≤ 850 N/mm <sup>2</sup>	Nickel alloys 1 ≤ 850 N/mm <sup>2</sup>	< 250	< 850	> 25
	52 Nickellegierung 2 > 850 - ≤ 1150 N/mm <sup>2</sup>	Nickel alloys 2 > 850 - ≤ 1150 N/mm <sup>2</sup>	> 250	> 850	< 25
	53 Nickellegierung 3 > 1150 - ≤ 1600 N/mm <sup>2</sup>	Nickel alloys 3 > 1150 - ≤ 1600 N/mm <sup>2</sup>	> 340	> 1150	< 20
<b>60</b> Kupfer Copper	61 Reinkupfer (Elektrolytkupfer)	Pure copper (electrolytic copper)	< 120	< 400	> 12
	62 Messing, Bronze, Rotguss (kurzspanend)	Short chip brass, phosphor bronze, gun metal	< 200	< 700	< 12
	63 Messing (langspanend)	Long chip brass	< 200	< 700	> 12
	64 Messing bleifrei	Lead free brass	< 220	< 700	> 15
<b>70</b> Aluminium Magnesium Aluminium Magnesium	71 Al unlegiert	Al unalloyed	< 100	< 350	> 15
	72 Al legiert Si < 1.5 %	Al alloyed Si < 1.5 %	< 150	< 500	> 15
	73 Al legiert Si > 1.5 % - < 10 %	Al alloyed Si > 1.5 % - < 10 %	< 120	< 400	< 15
	74 Al legiert Si > 10 %, Mg-Legierungen	Al alloyed Si > 10 %, Mg-alloys	< 120	< 400	< 10
<b>80</b> Kunststoff Plastic compounds	81 Thermoplaste	Thermoplastics	-	-	-
	82 Duroplaste	Duroplastics	-	-	-
	83 Faserverstärkte Kunststoffe	Glass fibre reinforced plastics	-	-	-
<b>90</b> Edelmetalle Precious metals	91 Gelbgold	Yellow gold	-	-	-
	92 Rotgold	Red gold	-	-	-
	93 Weissgold	White gold	-	-	-
	94 Silber	Silver	-	-	-



# KLASSISCHES GEWINDESCHNEIDEN — CLASSIC THREAD CUTTING



<b>Ab Seite:</b> <b>From page:</b>
MJ / M
MF
UNJC / UNC / UNC(J)
UNJF / UNF / UNF(J)
UNEF / UN / UNS
G / Rp / Rc / W / SV
NPT / NPTF
PG / TR
EG M / EG UNC / EG UNF

<b>N</b> Normale Werkstoffe Normal materials											
60	62	60	64	64	72	72	74	60	74	74	
N.10	N.20	N.20V	N.20TN	N.20TC	N.50	N.50V	N.60	N.60V	N.60TN	N.60TC	
Standard +V / +NV	Beschichtet Coated TN / TC / DL / VS										
11	10 - 15	25 - 35									
12	10 - 15	25 - 35									
13	8 - 12	16 - 24									
14	8 - 12	16 - 24									
15	3 - 5	6 - 12									
16	3 - 5	3 - 5									
17	2 - 4										
18											
21	10 - 15	20 - 30									
22	3 - 6	6 - 12									
23	3 - 6	6 - 12									
24		4 - 8									
31	10 - 15	20 - 30									
32	10 - 15	20 - 30									
41	4 - 8	4 - 8									
42	3 - 5	3 - 5									
51		6 - 12									
52	4 - 8	4 - 8									
53	2 - 4										
61	8 - 12	12 - 16									
62	20 - 30	30 - 40									
63	16 - 24										
64	16 - 24										
71	10 - 15	20 - 40									
72	20 - 30	20 - 40									
73	10 - 15	20 - 30									
74	10 - 15	20 - 30									
81	20 - 30	30 - 50									
82	8 - 16	16 - 24									
83		8 - 16									
91	20 - 30										
92		12 - 16									
93		4 - 8									
94		16 - 24									

<b>W</b> Weiche Werkstoffe Soft materials			
86	86	87	87
W.20	W.20DL	W.60	W.60DL
Standard	Beschichtet Coated DL / VS		
11			
12			
13			
14			
15			
16			
17			
18			
21			
22			
23			
24			
31			
32			
41			
42			
51			
52			
53			
61			
62			
63			
64			
71			
72			
73			
74			
81			
82			
83			
91			
92			
93			
94			

	V <sub>c</sub> (m/min)	
	< Ø 20 mm Guide Line	
	Standard +V / +NV	Beschichtet Coated TN / TC / DL / VS
11	10 - 15	25 - 35
12	10 - 15	25 - 35
13	8 - 12	16 - 24
14	8 - 12	16 - 24
15	3 - 5	6 - 12
16	3 - 5	3 - 5
17	2 - 4	
18		
21	10 - 15	20 - 30
22	3 - 6	6 - 12
23	3 - 6	6 - 12
24		4 - 8
31	10 - 15	20 - 30
32	10 - 15	20 - 30
41	4 - 8	4 - 8
42	3 - 5	3 - 5
51		6 - 12
52	4 - 8	4 - 8
53	2 - 4	
61	8 - 12	12 - 16
62	20 - 30	30 - 40
63	16 - 24	
64	16 - 24	
71	10 - 15	20 - 40
72	20 - 30	20 - 40
73	10 - 15	20 - 30
74	10 - 15	20 - 30
81	20 - 30	30 - 50
82	8 - 16	16 - 24
83		8 - 16
91	20 - 30	
92		12 - 16
93		4 - 8
94		16 - 24

**E** Geeignet mit Emulsion  
Suitable with emulsion

**A** Optimal mit Luft  
Optimal with air

**A** Geeignet mit Luft  
Suitable with air



# KLASSISCHES UND SYNCHRON-GEWINDESCHNEIDEN CLASSIC THREAD CUTTING AND RIGID TAPPING



Ab Seite: From page:
MJ / M
MF
UNJC / UNC / UNC(J)
UNJF / UNF / UNF(J)
UNEF / UN / UNS
G / Rp / Rc / W / SV
NPT / NPTF
PG / TR
EG M / EG UNC / EG UNF

K Spanbrecher Swarf breaker	
104	105
142	



K.13TC	K.13VS
--------	--------



QTAP Allrounder Allrounder			
61	106	61	107
143	143	144	144
167	167	168	168
192	192	193	193
210	210	211	211

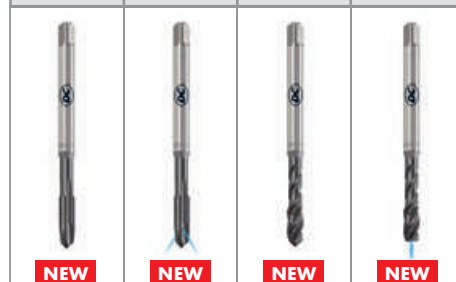

NEW	NEW	NEW	NEW
-----	-----	-----	-----

Q.20VS	Q.23VS	Q.60VS	Q.63VS
--------	--------	--------	--------



	Vc (m/min) Guide Line			
	Ø 5 - 10.9 mm	Ø 11 - 18.9 mm	Ø 19 - 31.9 mm	Ø 32 - 42 mm
11	30 - 40	20 - 30	20 - 30	20 - 30
12	30 - 40	20 - 30	20 - 30	20 - 30
13	30 - 40	20 - 30	20 - 30	20 - 30
14	20 - 30	15 - 25	15 - 25	15 - 25
15	15 - 20	10 - 15	8 - 12	5 - 8
16	8 - 12	5 - 8	5 - 8	5 - 8
17				
18				
21				
22				
23				
24				
31	30 - 40	30 - 40	30 - 40	30 - 40
32	30 - 40	20 - 30	20 - 30	20 - 30
41				
42				
51				
52				
53				
61				
62	30 - 40	30 - 40	30 - 40	30 - 40
63	30 - 40	30 - 40	30 - 40	30 - 40
64	30 - 40	20 - 30	20 - 30	20 - 30
71				
72				
73				
74	30 - 40	30 - 40	30 - 40	30 - 40
81				
82				
83	30 - 40	30 - 40	30 - 40	30 - 40
91				
92				
93				
94				

	Vc (m/min) Guide Line				
	Ø 2.8 - 20 mm	Ø 2.8 - 20 mm	Ø 2.8 - 20 mm	Ø 2.8 - 20 mm	
20 - 40	OE	OE	OE	OE	11
20 - 40	OE	OE	OE	OE	12
16 - 24	OE	OE	OE	OE	13
16 - 24	OE	OE	OE	OE	14
6 - 12	OE	OE	OE	OE	15
					16
					17
					18
20 - 40	OE	OE	OE	OE	21
6 - 12	OE	OE	OE	OE	22
6 - 12	OE	OE	OE	OE	23
4 - 8	OE	OE	OE	OE	24
20 - 40	OE A	OE	OE A	OE	31
20 - 40	OE	OE	OE	OE	32
					41
					42
6 - 12	OE	OE	OE	OE	51
4 - 8	OE	OE	OE	OE	52
					53
12 - 16	OE	OE	OE	OE	61
25 - 35	OE	OE	OE	OE	62
20 - 40	OE	OE	OE	OE	63
20 - 40	OE	OE	OE	OE	64
20 - 40	OE	OE	OE	OE	71
20 - 40	OE	OE	OE	OE	72
20 - 40	OE	OE	OE	OE	73
20 - 40	OE A	OE	OE A	OE	74
20 - 40	OE A	OE	OE A	OE	81
16 - 24	OE	OE	OE	OE	82
8 - 16	OE A	OE	OE A	OE	83
20 - 40	OE	OE	OE	OE	91
12 - 16	OE	OE	OE	OE	92
					93
12 - 16	OE	OE	OE	OE	94

**E** Geeignet mit Emulsion  
Suitable with emulsion

**A** Optimal mit Luft  
Optimal with air

**A** Geeignet mit Luft  
Suitable with air



# SYNCHRON-GEWINDESCHNEIDEN – RIGID TAPPING



Ab Seite:  
From page:

MJ / M	108	108	109	109
MF	145		145	
UNJC / UNC / UNC(J)	169		169	
UNJF / UNF / UNF(J)	194		194	
UNEF / UN / UNS				
G / Rp / Rc / W / SV			212	
NPT / NPTF				
PG / TR				
EG M / EG UNC / EG UNF				

RTS Synchro Synchro				
	108	108	109	109
RTS.20VS	RTS.23VS	RTS.60VS RTS.62VS	RTS.65VS	

Z Zähe Werkstoffe Tough materials		
	90	90
Z.70VS	Z.73VS	

S Sonderlegierte Werkstoffe Special alloys			
	46	48	50
S.70VX	S.73VX		





Vc  
(m/min)  
Guide Line

Ø 2 - 2.8 mm    Ø 2.8 - 20 mm





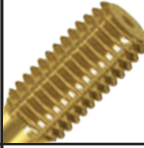

11	12 - 20	20 - 40
12	12 - 20	20 - 40
13	12 - 20	16 - 24
14	12 - 20	16 - 24
15	5 - 10	6 - 12
16		
17		
18		
21	12 - 20	20 - 40
22	4 - 10	6 - 12
23	4 - 10	6 - 12
24	4 - 8	4 - 8
31	12 - 20	20 - 40
32	12 - 20	20 - 40
41		
42		
51	4 - 10	6 - 12
52		4 - 8
53		
61	10 - 16	10 - 20
62		
63	12 - 20	20 - 40
64	12 - 20	20 - 40
71	12 - 20	30 - 50
72	12 - 20	30 - 50
73	12 - 20	20 - 40
74	12 - 20	20 - 40
81	12 - 20	30 - 50
82	12 - 20	16 - 24
83	4 - 10	8 - 16
91	12 - 20	20 - 40
92	6 - 12	12 - 16
93		
94	6 - 12	12 - 16

11
12
13
14
15
16
17
18
21
22
23
24
31
32
41
42
51
52
53
61
62
63
64
71
72
73
74
81
82
83
91
92
93
94

# REGISTER — REGISTER







	<b>Gewindeschneiden klassisch</b> Classic thread cutting		<b>Gewindeschneiden klassisch und synchron</b> Classic thread cutting and Rigid Tapping
<b>MJ</b> S 46 SA 46/47 TL 47 <b>UNJC</b> S 48 SA 48/49 TL 49 <b>UNJF</b> S 50 SA 50/51 TL 51 <b>M</b> N 60/62-85/114-115/118 NP 116-117 W 86-87 Z 88-91 ZX 93 H 94-97 S 98-99 SA 99-101 TL 100-101 GG 102-103 <b>MF</b> N 124-133/146-148 Z 134-135 H 136-137 S 138 SA 139-141 TL 140-141 <b>UNC, UNC(J)</b> N 154-157/170-171 Z 158-160 H 161-162 S 163-164 SA 165-166 TL 165 <b>UNF, UNF(J), UNEF, UN, UNS</b> N 176-179/196-199 Z 180-182 H 184-185 S 186 SA 188-190 TL 188-189 <b>G (BSP), Rp, Rc, W, SV Schaublin</b> N 204-206/213-217 W 207 H 207 GG 207 Z 208-209 <b>NPT, NPTF, PG, TR</b> N 220-223 <b>EG M, EG UNC, EG UNF</b> N 226-227/230/233 Z 231/234 S 234 SA 228-229/232/234-235 TL 228/232/235		<b>M</b> K 104-105 Q 61/106-107 <b>MF</b> K 142 Q 143-144 <b>UNC, UNF</b> Q 167-168 / 192-193 <b>G (BSP)</b> Q 210-211	
			<b>Synchron-Gewindeschneiden</b> Rigid Tapping
		<b>M</b> RTS 108-112 Z.70/Z.73 90-91 <b>MF</b> RTS 145 Z.70 134-135 <b>UNC, UNC(J)</b> RTS 169 Z.70 160 <b>UNF, UNF(J)</b> RTS 194 Z.70 182 <b>G (BSP)</b> RTS 212 Z.70 209 <b>EG UNC, EG UNF</b> Z 231/234	
			<b>Gewindeformen</b> Thread forming
	<b>Kronengewindebohrer</b> Crown taps	<b>M</b> FS 254-255 FPS 256-258 FAS 259-261 <b>MF</b> FPS 262 FAS 262 <b>UNC</b> FS 263 FPS 263 FAS 263 <b>UNF</b> FS 264 FPS 264 FAS 264 <b>G (BSP)</b> FPS 265 FAS 265	
<b>M, MF, UN, G (BSP)</b> N 237-239			
	<b>Kombi-Gewindebohrer</b> Combination drill/taps		
<b>M, MF, UNC, G (BSP), PG</b> N 242-243			

## REGISTER — REGISTER

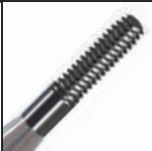
	<b>Schneideisen</b> Dies		<b>Gewindeschneidfutter SRT</b> Tapping chucks SRT	
<b>M</b> N 272/286/288/289      Z 273/286      Z.LL 273  <b>MF</b> N 274-276/287/288      Z 274-275  <b>UNC</b> N 277  <b>UNF, UNEF, UN, UNS</b> N 278-279  <b>G (BSP), R (DIN EN 10226, ISO 7-1)</b> N 280/282/289      Z 281      MS 281  <b>NPT, NPTF, PG, TR</b> N 283-284  <b>W</b> N 285/289	HSK 306      BT40 306 SK40/SK50 307      DIN 1835 B 308-309		<b>Einsätze</b> Inserts	
	<b>Gewindelehren</b> Thread gauges	S 310      SC 311		<b>Zubehör</b> Accessories
<b>M</b> D 294-295  <b>MF</b> D 296-299  <b>UNC</b> D 300  <b>UNF, UNEF</b> D 301  <b>G (BSP), PG</b> D 302  <b>NPT, NPTF</b> D 303  <b>EG M, EG UNC, EG UNF</b> D 304	<b>Vollhartmetall-Zentrierbohrer</b> Solide carbide spotting drills C315VS 318  <b>Vollhartmetall-Spiralbohrer</b> Solide carbide twist drills FZ315VS 319      F313VS 320 F285VS 320      F286VS 320  <b>Schneideisenhalter</b> Die stocks D5810 322  <b>Windeisen</b> Tap wrenches D5820 322  <b>Gewindebohrer-Verlängerungen</b> Tap extension sleeves D5830 323      D5840 323			
				
<b>Technische Informationen</b> <b>Liefer- und Zahlungsbedingungen</b>	<b>Weitere Informationen</b> finden Sie unter <a href="http://www.dcswiss.com">www.dcswiss.com</a>	<b>Technical information</b> <b>Delivery and payment conditions</b>	<b>Further information</b> are available on <a href="http://www.dcswiss.com">www.dcswiss.com</a>	



## REGISTER — REGISTER

	<b>Maschinengewindebohrer nano</b> <b>Machine taps nano</b>		<b>Maschinengewindeformer nano</b> <b>Machine thread formers nano</b>	
<p><b>M</b> TAN 338      TAZ 339      CMS 340</p> <p><b>MF</b> TAN 341      TAZ 342      CMS 343</p> <p><b>UNC</b> TAN 344      TAZ 345      CMS 346</p> <p><b>UNF</b> TAN 347      TAZ 348      CMS 349</p> <p><b>S</b> TAN 350      TAZ 351      CMS 352</p> <p><b>SF</b> TAN 353      TAZ 354      CMS 355</p> <p><b>SL</b> TAN 356      TAZ 357      CMS 358</p>		<p><b>M</b> FA80 363      FA83 363 CFA80 370      CFA83 370</p> <p><b>MF</b> FA80 364      FA83 364</p> <p><b>UNC</b> FA80 365      FA83 365 CFA80 371      CFA83 371</p> <p><b>UNF</b> FA80 366      FA83 366 CFA80 372      CFA83 372</p> <p><b>S</b> FA80 367      FA83 367 CFA80 373      CFA83 373</p> <p><b>SF</b> FA80 368      FA83 368</p> <p><b>SL</b> FA80 369      FA83 369</p>		
	<b>Gewindelehren nano</b> <b>Thread gauges nano</b>	 <p><i>Prüf-Gewindelehrdorne nano</i>      <b>Plug check gauges nano</b>  <i>Abnutzungsprüfdorne nano</i>      <b>Master plug gauges WEAR nano</b>  <i>Kalibrier-Gewindelehrdorne nano</i>      <b>Calibration thread plug gauges nano</b></p>		
<p><b>M</b> DN01 382      DN02 382      DZ04 383 DZ14 383      DN04 384      DN14 384</p> <p><b>MF</b> DN01 385      DN02 385      DZ04 386 DZ14 386      DN04 387      DN14 387</p> <p><b>UNC, UNF</b> DN01 388      DN02 388      DZ04 389 DZ14 389      DN04 390      DN14 390</p> <p><b>S NIHS, S NIHS NT</b> DN01 391-392      DN02 391-392      DZ04 393 DZ14 393      DN04 394      DN14 394</p> <p><b>SF NIHS, SF NIHS NT</b> DN01 395      DN02 395      DZ04 396 DZ14 396      DN04 397      DN14 397</p> <p><b>*SL</b> DN01 398      DN02 398      <i>*SL: nur ohne Zertifikat SCS lieferbar</i>  <i>*SL: only available without certificate SCS</i></p> <p> <i>Alle nano-Gewindelehrdorne sind SCS-zertifiziert und das kostenpflichtige Zertifikat auf Bestellung lieferbar.</i>  <i>All nano thread plug gauges are SCS-certified and the paid certificate is available on request.</i></p> <p> <i>Alle nano-Gewindelehrringe haben ein Prüfzertifikat, realisiert mit SCS-akkreditierten Prüf-Gewindelehrdornen.</i>  <i>Das kostenpflichtige Prüfzertifikat ist auf Bestellung lieferbar.</i>  <i>All nano ring gauges have a certificate of measurement, established with SCS certified plug check gauges.</i>  <i>The paid certificate is available on request.</i></p>		<p><b>M</b> RN05-1 399      RN15-1 399      RN05-2 400 RN15-2 400      RN05-3 401      RN15-3 401</p> <p><b>MF</b> RN05-1 402      RN15-1 402      RN05-2 403 RN15-2 403      RN05-3 404      RN15-3 404</p> <p><b>UNC, UNF</b> RN05-1 405      RN15-1 405      RN05-2 406 RN15-2 406</p> <p><b>S NIHS, S NIHS NT</b> RN05-1 407      RN15-1 407      RN05-2 408 RN15-2 408</p> <p><b>SF NIHS, SF NIHS NT</b> RN05-1 409      RN15-1 409      RN05-2 410 RN15-2 410</p> <p><b>S NIHS</b> EN00 411</p> <p> <i>Mit SCS-Zertifikat.</i>  <i>SCS certificate included.</i></p>		

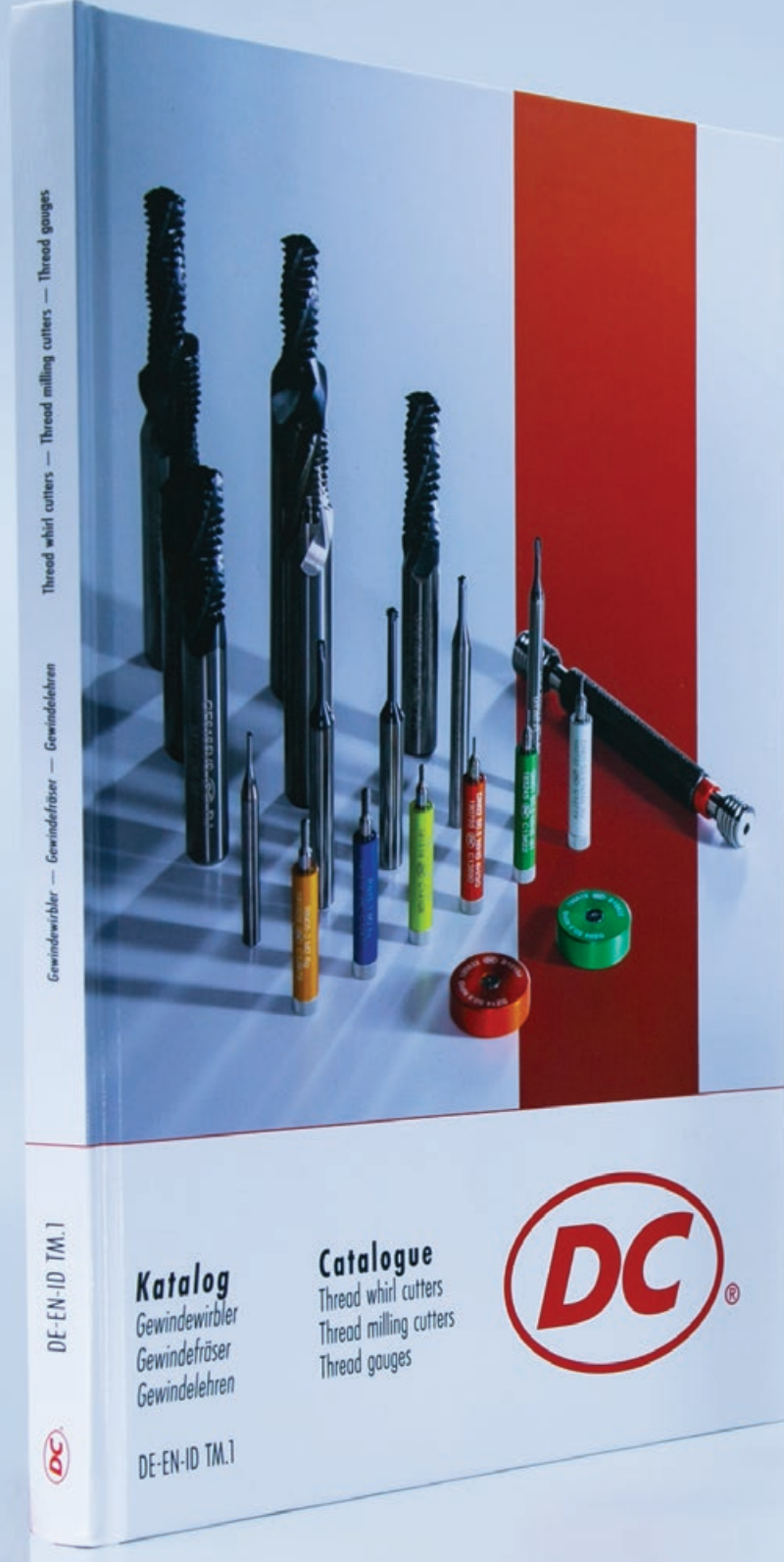













**FÜR VHM-GEWINDEFÄRÄSER UND GEWINDEWIRBLER  
FRAGEN SIE BITTE NACH UNSEREM  
**KATALOG TM!****

**FOR SOLID CARBIDE THREAD MILLING CUTTERS AND  
THREAD WHIRL CUTTERS PLEASE ASK FOR OUR  
**CATALOGUE TM!****

# MJ, UNJC, UNJF

Inhaltsverzeichnis — Maschinengewindebohrer MJ ISO 5855,  
UNJC / UNJF ISO 3161/ASME B1.15

Directory — Machine taps MJ ISO 5855, UNJC / UNJF ISO 3161/ASME B1.15

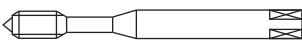
				S		SA	
<b>Merkmale</b> Characteristics							
		VS	VX				
							
		NEW	NEW	NEW	NEW		
<b>Lochart</b> Hole type							
		S320VS-4	S370VX-3	SA320-4	SA350-3		
MJ 4H6H /4H5H	ISO 5855	DIN lang DIN long	DIN 371	46	46	47	47
UNJC 3B	ISO 3161/ASME B1.15	DIN lang DIN long	DIN 371	48	48	49	49
UNJF 3B	ISO 3161/ASME B1.15	DIN lang DIN long	DIN 371	50	50	51	51



**Composites**  
GWi3067VX



**Super alloys**  
SA390-3



**Titanium alloys**  
TL351VS-3

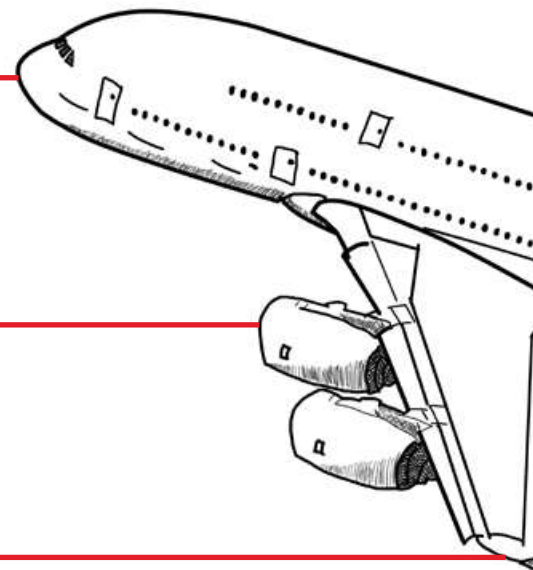



# MJ, UNJC, UNJF

Inhaltsverzeichnis — Maschinengewindebohrer MJ ISO 5855,  
UNJC / UNJF ISO 3161/ASME B1.15

Directory — Machine taps MJ ISO 5855, UNJC / UNJF ISO 3161/ASME B1.15

SA	TL
 R10	 R15  VS
 <b>NEW</b>	 <b>NEW</b>
	
<b>SA390-3</b>	<b>TL351VS-3</b>
46	47
48	49
50	51

**Aluminium alloys**  
**W360DL-3**

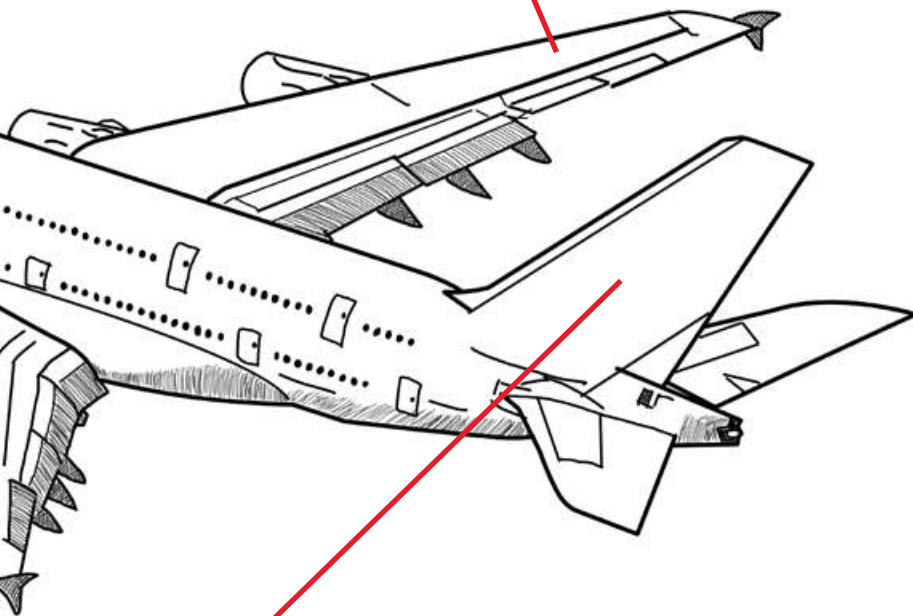

**Glass fibre reinforced plastics**  
**H350TC-3**



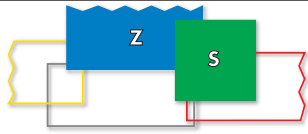
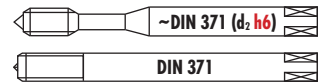
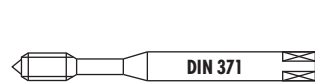

**S320VS-4**

**S370VX-3**

**S320VS-4**      **S370VX-3**      **SA390-3**



**aero**

**SA390-3**

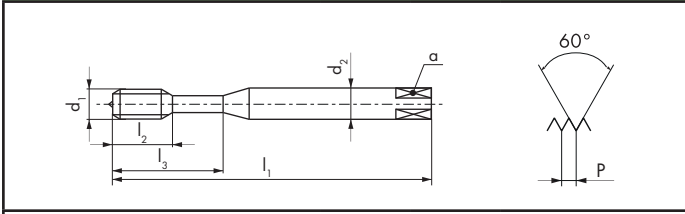
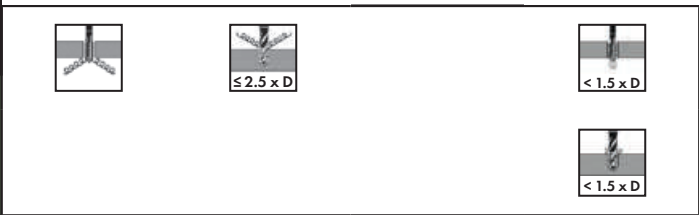

**B** 4 x P      **C** 2.5 x P      **C** 2.5 x P

**4H5H**      **4H5H**      **4H5H**

$\varnothing d_1$ MJ	P mm	$l_1$ mm	$l_2$ mm	$l_3$ mm	$d_2$ mm	$a$ mm			ID
3	0.5	56	12	18	3.5	2.7	3	2.55	● 198966
4	0.7	63	14	21	4.5	3.4	3	3.4	● 198967
5	0.8	70	15	25	6	4.9	3	4.3	● 198968
6	1	80	17	30	6	4.9	3	5.1	● 198969
8	1	90	20	35	8	6.2	3	7.1	● 198970
8	1.25	90	20	35	8	6.2	3	6.9	● 198971
10	1.25	100	22	39	10	8	3	8.9	● 198972
10	1.5	100	22	39	10	8	3	8.6	● 198973

$\varnothing d_1$ MJ	P mm	$l_1$ mm	$l_2$ mm	$l_3$ mm	$d_2$ h6 mm	$a$ mm			ID
3	0.5	56	5.5	18	3.5(h9)	2.7	3	2.55	● 198974
4	0.7	63	7.5	21	4.5(h9)	3.4	3	3.4	● 198975
5	0.8	70	9	25	6	4.9	3	4.3	● 198976
6	1	80	11	30	6	4.9	3	5.1	● 198977
8	1	90	12.5	35	8	6.2	3	7.1	● 198978
8	1.25	90	12.5	35	8	6.2	3	6.9	● 198979
10	1.25	100	14	39	10	8	3	8.9	● 198980
10	1.5	100	14	39	10	8	3	8.6	● 198981

$\varnothing d_1$ MJ	P mm	$l_1$ mm	$l_2$ mm	$d_2$ mm	$a$ mm			ID
3	0.5	56	12	3.5	2.7	3	2.55	● 199006
4	0.7	63	14	4.5	3.4	3	3.4	● 199007
5	0.8	70	15	6	4.9	3	4.3	● 199008
6	1	80	20	6	4.9	3	5.1	● 199009
8	1	90	25	8	6.2	3	7.1	● 199010
8	1.25	90	25	8	6.2	3	6.9	● 199011
10	1.25	100	30	10	8	3	8.9	● 199012
10	1.5	100	30	10	8	3	8.6	● 199013

≤MJ5x0.8 = **4H6H**

# aero

SA320-4



15 16 52 64

SA350-3



15 16 52 64

TL351VS-3



41 42

SA320-4

SA350-3

TL351VS-3



NEW



NEW



NEW

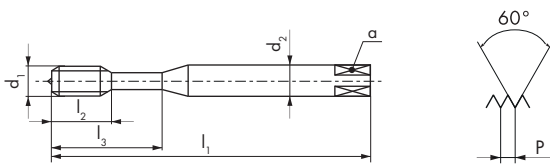

$\emptyset d_1$ MJ	P mm	$l_1$ mm	$l_2$ mm	$l_3$ mm	$d_2$ mm	a mm			ID	ID	ID
3	0.5	56	12		3.5	2.7	3	2.55	● 198990	● 198998	● 198982
4	0.7	63	14		4.5	3.4	3	3.4	● 198991	● 198999	● 198983
5	0.8	70	15		6	4.9	3	4.3	● 198992	● 199000	● 198984
6	1	80	15	23	6	4.9	3	5.1	● 198993	● 199001	● 198985
8	1	90	18	29	8	6.2	3	7.1	● 198994	● 199002	● 198986
8	1.25	90	18	29	8	6.2	3	6.9	● 198995	● 199003	● 198987
10	1.25	100	20	33	10	8	3	8.9	● 198996	● 199004	● 198988
10	1.5	100	20	33	10	8	3	8.6	● 198997	● 199005	● 198989

≤MJ5x0.8 = **4H6H**



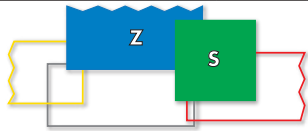
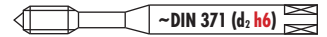
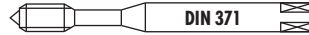

**S320VS-4**

**S370VX-3**

**S320VS-4**      **S370VX-3**      **SA390-3**



# aero

**SA390-3**

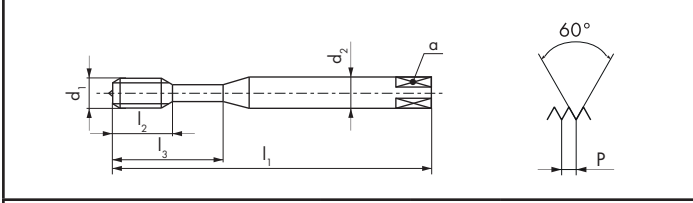
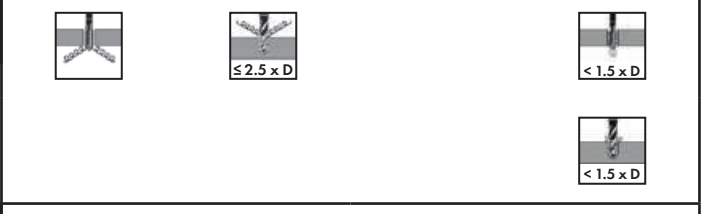

**B** 4 x P      **C** 2.5 x P      **C** 2.5 x P

**3B**      **3B**      **3B**

$\varnothing''$ d <sub>1</sub> UNJC	P TPI	d <sub>1</sub> mm	l <sub>1</sub> mm	l <sub>2</sub> mm	l <sub>3</sub> mm	d <sub>2</sub> mm	a mm			ID
6	32	3.5	56	13	20	4	3	3	2.8	● 199014
8	32	4.16	63	14	21	4.5	3.4	3	3.45	● 199015
10	24	4.82	70	15	25	6	4.9	3	3.9	● 199016
1/4	20	6.35	80	17	30	7	5.5	3	5.2	● 199017

ID
● 199018
● 199019
● 199020
● 199021

$\varnothing''$ d <sub>1</sub> UNJC	P TPI	d <sub>1</sub> mm	l <sub>1</sub> mm	l <sub>2</sub> mm	l <sub>3</sub> mm	d <sub>2</sub> h <sub>6</sub> mm	a mm			ID
6	32	3.5	56	6.5	20	4 (h9)	3	3	2.8	● 199018
8	32	4.16	63	7.5	21	4.5(h9)	3.4	3	3.45	● 199019
10	24	4.82	70	9	25	6	4.9	3	3.9	● 199020
1/4	20	6.35	80	11	30	6	4.9	3	5.2	● 199021

ID
● 199018
● 199019
● 199020
● 199021

$\varnothing''$ d <sub>1</sub> UNJC	P TPI	d <sub>1</sub> mm	l <sub>1</sub> mm	l <sub>2</sub> mm	d <sub>2</sub> mm	a mm			ID
6	32	3.5	56	13	4	3	3	2.8	● 199034
8	32	4.16	63	14	4.5	3.4	3	3.45	● 199035
10	24	4.82	70	15	6	4.9	3	3.9	● 199036
1/4	20	6.35	80	20	7	5.5	3	5.2	● 199037

ID
● 199034
● 199035
● 199036
● 199037

## aero

SA320-4



15 16 52 64

SA350-3



15 16 52 64

TL351VS-3



41 42

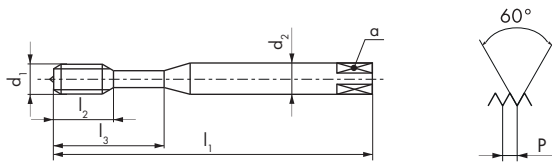

SA320-4

SA350-3

TL351VS-3



NEW





NEW



NEW



$\emptyset$ " d <sub>1</sub> UNJC	P TPI	d <sub>1</sub> mm	l <sub>1</sub> mm	l <sub>2</sub> mm	l <sub>3</sub> mm	d <sub>2</sub> mm	a mm		
6	32	3.5	56	13		4	3	3	2.8
8	32	4.16	63	14		4.5	3.4	3	3.45
10	24	4.82	70	15		6	4.9	3	3.9
1/4	20	6.35	80	15	23	7	5.5	3	5.2

ID	ID	ID
● 199026	● 199030	● 199022
● 199027	● 199031	● 199023
● 199028	● 199032	● 199024
● 199029	● 199033	● 199025

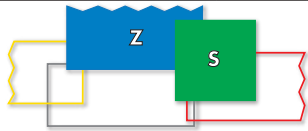
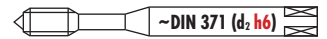
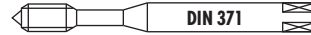

S320VS-4



S370VX-3



# aero

SA390-3



S320VS-4

S370VX-3

SA390-3



NEW

NEW

NEW



≤ 2.5 x D

< 1.5 x D



< 1.5 x D

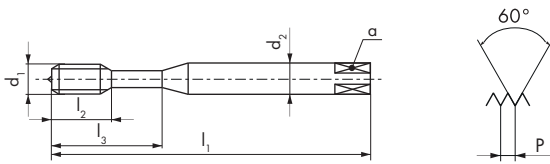

Ø" d <sub>1</sub> UNJF	P TPI	d <sub>1</sub> mm	l <sub>1</sub> mm	l <sub>2</sub> mm	l <sub>3</sub> mm	d <sub>2</sub> mm	a mm		
10	32	4.82	70	15	25	6	4.9	3	4.1
1/4	28	6.35	80	17	30	7	5.5	3	5.55
5/16	24	7.93	90	20	35	8	6.2	3	7
3/8	24	9.52	100	22	39	10	8	3	8.6

ID

- 199038
- 199039
- 199040
- 199041

Ø" d <sub>1</sub> UNJF	P TPI	d <sub>1</sub> mm	l <sub>1</sub> mm	l <sub>2</sub> mm	l <sub>3</sub> mm	d <sub>2</sub> h <sub>6</sub> mm	a mm		
10	32	4.82	70	9	25	6	4.9	3	4.1
1/4	28	6.35	80	11	30	6	4.9	3	5.55
5/16	24	7.93	90	12.5	35	8	6.2	3	7
3/8	24	9.52	100	14	39	10	8	3	8.6

ID

- 197707
- 197708
- 197709
- 197710

Ø" d <sub>1</sub> UNJF	P TPI	d <sub>1</sub> mm	l <sub>1</sub> mm	l <sub>2</sub> mm	d <sub>2</sub> mm	a mm		
10	32	4.82	70	15	6	4.9	3	4.1
1/4	28	6.35	80	20	7	5.5	3	5.55
5/16	24	7.93	90	25	8	6.2	3	7
3/8	24	9.52	100	30	10	8	3	8.6

ID

- 199049
- 199050
- 199051
- 199052

## aero

SA320-4



15 16 52 64

SA350-3



15 16 52 64

TL351VS-3



41 42

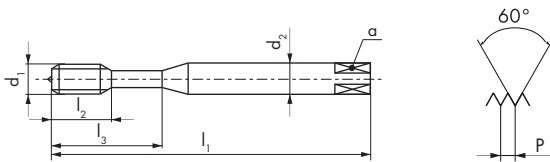

SA320-4

SA350-3

TL351VS-3



NEW



NEW



NEW



3B



3B









































3B























Ø" d <sub>1</sub> UNJF	P TPI	d <sub>1</sub> mm	l <sub>1</sub> mm	l <sub>2</sub> mm	l <sub>3</sub> mm	d <sub>2</sub> mm	a mm		
10	32	4.82	70	15		6	4.9	3	4.1
1/4	28	6.35	80	15	23	7	5.5	3	5.55
5/16	24	7.93	90	18	29	8	6.2	3	7
3/8	24	9.52	100	20	33	10	8	3	8.6

ID	ID	ID
● 174976	● 188175	● 199042
● 175993	● 199046	● 199043
● 175995	● 199047	● 199044
● 175997	● 199048	● 199045



		N								
Merkmale Characteristics										
			V		TiN	TiCN				
Lochart Hole type										
		<b>N310-3</b>	<b>N320-3 N320-4</b>	<b>N320V-3 N320V-4</b>	<b>N320TN-3/-4 N320TC-3/-4</b>	<b>N321-3 N321-4</b>	<b>N330-3 N330-4</b>	<b>N330V-3 N330V-4</b>		
DIN lang DIN long	DIN 371	60 / 62	62 / 64	60 / 64	64	70	70	70		
Extra-lang Extra-long	DC									
ISO kurz ISO short	ISO 529									
DIN kurz DIN short	DIN 352									
Toleranz Tolerance	ISO 2 6H	60 / 62	62 / 64	60 / 64	64	70	70	70		
Übermass Oversize	ISO 3 6G		68	68						
Übermass Oversize	7G		68							
Übermass Oversize	+ 0.10 mm + 0.20 mm		68							
Feintoleranz Fine tolerance	ISO 1 4H		66							
LH Linksgewinde LH Left-hand thread	ISO 2 6H	62	66	66						
		<b>N410-3</b>	<b>N420-4</b>	<b>N420V-4</b>	<b>N420TN-4 N420TC-4</b>	<b>N421-4</b>	<b>N430-4</b>	<b>N430V-4</b>		
DIN lang DIN long	DIN 376	63	65	65	65	71	71	71		
Extra-lang Extra-long	DC									
ISO kurz ISO short	ISO 529									
DIN kurz DIN short	DIN 352									
Toleranz Tolerance	ISO 2 6H	63	65	65	65	71	71	71		
Übermass Oversize	ISO 3 6G		69	69						
Übermass Oversize	7G		69							
Übermass Oversize	+ 0.10 mm + 0.20 mm		69 / 71							
Feintoleranz Fine tolerance	ISO 1 4H		67							
LH Linksgewinde LH Left-hand thread	ISO 2 6H	63	67	67						

N								
 R15 	 R40	 R40 	 R40  TiN  TiCN	 R40  V  E 1.5xP	 R40 	 R40  		 
			 	 				
								
<b>N350-3</b> <b>N350V-3</b>	<b>N360-3</b>	<b>N360V-3</b>	<b>N360TN-3</b> <b>N360TC-3</b>	<b>N360-5</b> <b>N360V-5</b>	<b>N361-3</b>	<b>N362V-3</b>	<b>N520-4</b>	<b>N520V-4</b>
72	74	60 / 74	74	80	80	80		
							82	82
72	74	60 / 74	74	80	80	80	82	82
	76	76						
	78	78						
	78	78						
	78							
	76	76						
<b>N450-3</b> <b>N450V-3</b>	<b>N460-3</b>	<b>N460V-3</b>	<b>N460TN-3</b> <b>N460TC-3</b>	<b>N460-5</b> <b>N460V-5</b>	<b>N461-3</b>	<b>N462V-3</b>	<b>N620-4</b>	<b>N620V-4</b>
73	75	75	75	81	81	81		
							83	83
73	75	75	75	81	81	81	83	83
	77	77						
	79	79						
	79	79						
	79							
	77	77						

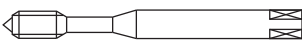
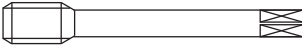









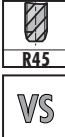
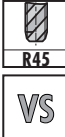

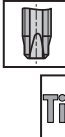
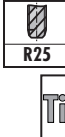

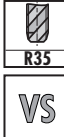



		N								
Merkmale Characteristics		 TiN	 R40	 R40	 V	 R40	 TiN	 DC	 R40	 DC
										
Lochart Hole type										
		N520TN-4	N560-3	N560V-3	N560TN-3	N1120-4	N1160-3	N1110 -1 -2 -3 -S		
DIN lang DIN long	DIN 371									
Extra-lang Extra-long	DC	82	84	84	84					
ISO kurz ISO short	ISO 529					118	118	60 / 114		
DIN kurz DIN short	DIN 352									
Toleranz Tolerance	ISO 2 6H	82	84	84	84	118	118	60 / 114		
Übermass Oversize	ISO 3 6G									
Übermass Oversize	7G									
Übermass Oversize	+ 0.10 mm + 0.20 mm									
Feintoleranz Fine tolerance	ISO 1 4H									
LH Linksgewinde LH Left-hand thread	ISO 2 6H									
		N620TN-4	N660-3	N660V-3	N660TN-3	N1220-4	N1260-3	N1210 -1 -2 -3 -S		
DIN lang DIN long	DIN 376									
Extra-lang Extra-long	DC	83	85	85	85					
ISO kurz ISO short	ISO 529					118	118	60 / 115		
DIN kurz DIN short	DIN 352									
Toleranz Tolerance	ISO 2 6H	83	85	85	85	118	118	60 / 115		
Übermass Oversize	ISO 3 6G									
Übermass Oversize	7G									
Übermass Oversize	+ 0.10 mm + 0.20 mm									
Feintoleranz Fine tolerance	ISO 1 4H									
LH Linksgewinde LH Left-hand thread	ISO 2 6H									



**Inhaltsverzeichnis — Maschinen- und Handgewindebohrer ISO DIN 13**  
**Directory — Machine and hand taps ISO DIN 13**

N	W				Z			
 	 	 DLC	 R40	 R40 DLC	 V	 VS	 R40 V	 R40 VS
 <b>NEW</b>								
<b>NP110-S</b> -1 -2 -3 -S	<b>W320-3</b> W320-4	<b>W320DL-3</b> W320DL-4	<b>W360-3</b>	<b>W360DL-3</b>	<b>Z320V-3</b> Z320V-4	<b>Z320VS-4</b>	<b>Z360V-3</b> Z362V-3	<b>Z360VS-3</b> Z362VS-3
	86	86	87	87	88	88	89	90
116								
116	86	86	87	87	88	88	89	90
<b>NP210-S</b> -1 -2 -3 -S	<b>W420-4</b>	<b>W420DL-4</b>	<b>W460-3</b>	<b>W460DL-3</b>	<b>Z420V-4</b>	<b>Z420VS-4</b>	<b>Z462V-3</b>	<b>Z462VS-3</b>
	86	86	87	87	88	88	89	91
117								
117	86	86	87	87	88	88	89	91



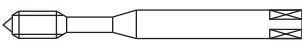
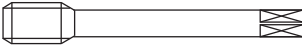

































	Z		ZX	H		S		
<b>Merkmale</b> <b>Characteristics</b>								
			 <b>NEW</b>					
<b>Lochart</b> <b>Hole type</b>								
	<b>Z370VS-3</b>	<b>Z373VS-3</b>	<b>ZX320-4</b>	<b>H320-4</b> <b>H320TC-4</b>	<b>H350-3</b> <b>H350TC-3</b>	<b>S320VS-4</b>	<b>S360VS-3</b>	
<b>DIN lang</b> <b>DIN long</b>	DIN 371	90	90	93	94	96	98	99
<b>Extra-lang</b> <b>Extra-long</b>	DC							
<b>ISO kurz</b> <b>ISO short</b>	ISO 529							
<b>DIN kurz</b> <b>DIN short</b>	DIN 352							
<b>Toleranz</b> <b>Tolerance</b>	ISO 2 6H	90	90	93	94	96	98	99
<b>Übermass</b> <b>Oversize</b>	ISO 3 6G					96		
<b>Übermass</b> <b>Oversize</b>	7G							
<b>Übermass</b> <b>Oversize</b>	+ 0.10 mm + 0.20 mm							
<b>Feintoleranz</b> <b>Fine tolerance</b>	ISO 1 4H	90					98	
<b>LH Linksgewinde</b> <b>LH Left-hand thread</b>	ISO 2 6H							
	<b>Z470VS-3</b>	<b>Z473VS-3</b>	<b>ZX420-4</b>	<b>H420-4</b> <b>H420TC-4</b>	<b>H450-3</b> <b>H450TC-3</b>	<b>S420VS-4</b>	<b>S460VS-3</b>	
<b>DIN lang</b> <b>DIN long</b>	DIN 376	91	91	93	95	97	98	99
<b>Extra-lang</b> <b>Extra-long</b>	DC							
<b>ISO kurz</b> <b>ISO short</b>	ISO 529							
<b>DIN kurz</b> <b>DIN short</b>	DIN 352							
<b>Toleranz</b> <b>Tolerance</b>	ISO 2 6H	91	91	93	95	97	98	99
<b>Übermass</b> <b>Oversize</b>	ISO 3 6G					97		
<b>Übermass</b> <b>Oversize</b>	7G							
<b>Übermass</b> <b>Oversize</b>	+ 0.10 mm + 0.20 mm							
<b>Feintoleranz</b> <b>Fine tolerance</b>	ISO 1 4H							
<b>LH Linksgewinde</b> <b>LH Left-hand thread</b>	ISO 2 6H							









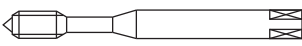
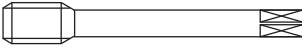

















# Inhaltsverzeichnis — Maschinengewindebohrer ISO DIN 13

## Directory — Machine taps ISO DIN 13



















SA			TL		GG			
	 R15	 R10	 VS	 R15 VS	 R15 NV	 R15 TiCN	 R15 TiCN	 R15 NV
<b>SA320-4</b>	<b>SA350-3</b>	<b>SA390-3</b>	<b>TL320VS-4</b>	<b>TL351VS-3</b>	<b>GG350NV-3</b>	<b>GG350TC-3</b>	<b>GG353TC-3</b>	<b>GG550NV-3</b>
100	100	99	100	100	102	102	102	102
100	100	99	100	100	102	102	102	102
100	100	99	100	100				
<b>SA420-4</b>	<b>SA450-3</b>		<b>TL420VS-4</b>	<b>TL451VS-3</b>	<b>GG450NV-3</b>	<b>GG450TC-3</b>	<b>GG453TC-3</b>	<b>GG650NV-3</b>
101	101		101	101	103	103	103	103
101	101		101	101	103	103	103	103
101	101		101	101				

		K			QTAP						
Merkmale Characteristics			TiCN		TiCN		VS		R40		R40
											
											
					<b>NEW</b>	<b>NEW</b>	<b>NEW</b>	<b>NEW</b>	<b>NEW</b>	<b>NEW</b>	<b>NEW</b>
Lochart Hole type											
		<b>K313TC-3</b>			<b>Q320VS-4</b>	<b>Q323VS-4</b>	<b>Q360VS-3</b>	<b>Q363VS-3</b>	<b>Q360VS-3</b>	<b>Q363VS-3</b>	<b>Q363VS-3</b>
DIN lang DIN long	DIN 371	104			61 / 106	106	61 / 107	107	61 / 107	107	107
Extra-lang Extra-long	DC										
ISO kurz ISO short	ISO 529										
DIN kurz DIN short	DIN 352										
Toleranz Tolerance	ISO 2 6H	104			61 / 106	106	61 / 107	107	61 / 107	107	107
Übermass Oversize	ISO 3 6G										
Übermass Oversize	7G										
Übermass Oversize	+ 0.10 mm + 0.20 mm										
Feintoleranz Fine tolerance	ISO 1 4H										
LH Linksgewinde LH Left-hand thread	ISO 2 6H										
		<b>K413TC-3</b>	<b>K613TC-3</b>	<b>K613VS-3</b>	<b>Q420VS-4</b>	<b>Q423VS-4</b>	<b>Q460VS-3</b>	<b>Q463VS-3</b>	<b>Q460VS-3</b>	<b>Q463VS-3</b>	<b>Q463VS-3</b>
DIN lang DIN long	DIN 376	104			106	106	107	107	106	106	107
Extra-lang Extra-long	DC		105	105							
ISO kurz ISO short	ISO 529										
DIN kurz DIN short	DIN 352										
Toleranz Tolerance	ISO 2 6H	104	105	105	106	106	107	107	106	106	107
Übermass Oversize	ISO 3 6G										
Übermass Oversize	7G										
Übermass Oversize	+ 0.10 mm + 0.20 mm										
Feintoleranz Fine tolerance	ISO 1 4H										
LH Linksgewinde LH Left-hand thread	ISO 2 6H										

RTS							
 VS	 VS	 R40 VS	 R40 VS	 R40 E 1.5xP VS	 R40 E 1.5xP VS	 VS	 R40 VS
							
							
<b>RTS320VS-4</b>	<b>RTS323VS-4</b>	<b>RTS360VS-3</b> <b>RTS362VS-3</b>	<b>RTS365VS-3</b>	<b>RTS362VS-5</b>	<b>RTS365VS-5</b>	<b>RTS523VS-4</b>	<b>RTS565VS-3</b>
108	108	109	109	111	111	112	112
108	108	109	109	111	111	112	112
		110					
		110					
<b>RTS420VS-4</b>	<b>RTS423VS-4</b>	<b>RTS462VS-3</b>	<b>RTS465VS-3</b>			<b>RTS623VS-4</b>	<b>RTS665VS-3</b>
108	108	109	109			112	112
108	108	109	109			112	112
		110					
		110					



**Gewindebohrer-Sortimente**  
**Tap assortments**

BOXSET	D5855	D5860	D5891
<p><b>D5855</b>   N1110-S M3, M4, M5, M6, M8, M10, N1210-S M12</p> <p><b>D5860</b>   N1110-S M3, M4, M5, M6, M8, M10, N1210-S M12    FO DIN 338 D2.5, 3.3, 4.2, 5.0, FO DIN 338 6.8, 8.5, 10.2</p> <p><b>D5891</b>   N310-3 M3, M4, M5, M6, M8, M10, N410-3 M12</p>			
<p>No D5855 / D5860 / D5891</p>	ID	ID	ID
<p>M3 - M12</p>	● 118728	● 118733	● 170922
<p><b>BOXSET</b></p>	<p><b>D5892</b></p>		
<p><b>D5892</b>    N320V-4 M3, M4, M5, M6, M8, M10  </p>			
<p>No D5892</p>	ID		
<p>M3 - M10</p>	● 170921		
<p><b>BOXSET</b></p>	<p><b>D5896</b></p>		
<p><b>D5896</b>    N360V-3 M3, M4, M5, M6, M8, M10  </p>			
<p>No D5896</p>	ID		
<p>M3 - M10</p>	● 167599		

**Gewindebohrer-Sortimente — QTAP**  
**Tap assortments — QTAP**



BOXSET	D5893
<p>Q320VS-4</p> <p>VS</p> <p>M3, M4, M5 M6, M8, M10</p>	<p><b>NEW</b></p>
<p>No D5893</p>	<p>ID</p>
<p>M3 - M10</p>	<p>• 197104</p>
BOXSET	D5897
<p>Q360VS-3</p> <p>VS</p> <p>M3, M4, M5 M6, M8, M10</p>	<p><b>NEW</b></p>
<p>No D5897</p>	<p>ID</p>
<p>M3 - M10</p>	<p>• 197105</p>

										N310-3	N310-3 LH	N320-3	
Ø d <sub>1</sub> M	P mm	l <sub>1</sub> mm	l <sub>2</sub> mm	l <sub>3</sub> mm	d <sub>2</sub> mm	a mm				ID	ID	ID	
1	0.25	40	5.5		2.5	2.1	3			● 150167			
1.1	0.25	40	5.5		2.5	2.1	3			● 174745			
1.2	0.25	40	5.5		2.5	2.1	3			● 150168			
1.4	0.3	40	7		2.5	2.1	3			● 150169			
1.5	0.3	40	7		2.5	2.1	3			● 174752			
1.6	0.35	40	8		2.5	2.1	3			● 174753			
1.7	0.35	40	8		2.5	2.1	3			● 174754			
1.8	0.35	40	8		2.5	2.1	3			● 174755			
2	0.4	45	8		2.8	2.1	3			● 101439	● 111460		
2.2	0.45	45	9		2.8	2.1	3			● 174756			
2.3	0.4	45	9		2.8	2.1	3			● 174757			
2.5	0.45	50	10		2.8	2.1	3			● 101440	● 111461		
2.6	0.45	50	10		2.8	2.1	3			● 101441			
3	0.5	56	12	18	3.5	2.7	3			● 101442	● 111462		
3.5	0.6	56	13	20	4	3	3			● 101443			
4	0.7	63	14	21	4.5	3.4	3			● 101444	● 111464		
5	0.8	70	15	25	6	4.9	* 3			● 101445	● 111465	* 101465	
6	1	80	17	30	6	4.9	* 3			● 101446	● 111466	* 101466	
8	1.25	90	20	35	8	6.2	3			● 101447			
10	1.5	100	22	39	10	8	3			● 101438			
* N320-3 =  2													≤ M1.5

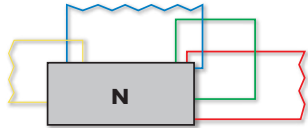

N410-3



31 62 73 74 91

N410-3 LH



LH

31 62 73 74 91





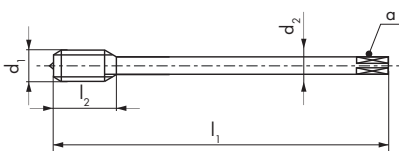





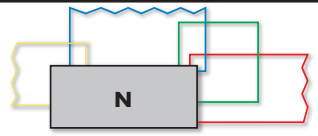





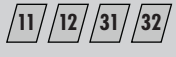

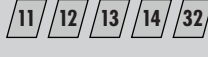



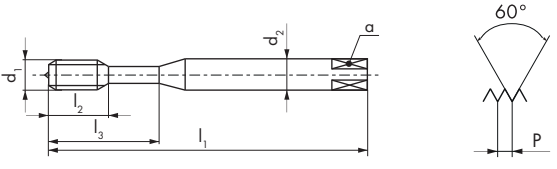

N410-3

N410-3 LH











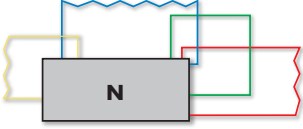

$\emptyset d_1$ M	P mm	$l_1$ mm	$l_2$ mm	$d_2$ mm	a mm			ID	ID
3	0.5	56	12	2.2	1.8	3	2.5	● 101897	
4	0.7	63	14	2.8	2.1	3	3.3	● 101924	
5	0.8	70	15	3.5	2.7	3	4.2	● 101942	
6	1	80	17	4.5	3.4	3	5	● 101953	
7	1	80	17	5.5	4.3	3	6	● 142645	● 111491
8	1.25	90	20	6	4.9	3	6.8	● 101958	● 111492
10	1.5	100	22	7	5.5	3	8.5	● 101866	● 111478
12	1.75	110	24	9	7	3	10.2	● 101870	● 111479
14	2	110	28	11	9	3	12	● 101874	● 111480
16	2	110	30	12	9	3	14	● 101880	● 111481
18	2.5	125	33	14	11	3	15.5	● 101883	● 111482
20	2.5	140	36	16	12	3	17.5	● 101885	● 125530
22	2.5	140	36	18	14.5	3	19.5	* 101888	
24	3	160	39	18	14.5	4	21	● 101891	● 111485
27	3	160	42	20	16	4	24	● 101895	● 111486
30	3.5	180	45	22	18	4	26.5	● 101901	● 111487
33	3.5	180	48	25	20	4	29.5	* 101907	
36	4	200	51	28	22	4	32	● 101915	● 111488
39	4	200	55	32	24	4	35	● 101922	
42	4.5	200	55	32	24	4	37.5	● 101932	
48	5	250	63	36	29	4	43	● 111489	
56	5.5	280	71	45	35	5	50.5	● 111447	

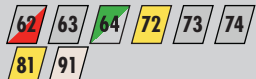

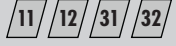
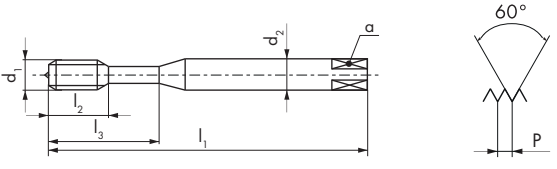
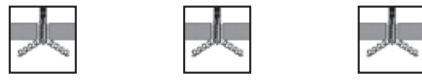
										N320-4	N320V-4	N320TN-4	N320TC-4
													
N320-4													
N320V-4	 												
N320TN-4	 												
N320TC-4	 												
										 	 	 	 
Ø d <sub>1</sub> M	P mm	l <sub>1</sub> mm	l <sub>2</sub> mm	l <sub>3</sub> mm	d <sub>2</sub> mm	a mm			ID	ID	ID	ID	
* 1	0.25	40	5.5		2.5	2.1	2	0.75	● 111467				
* 1.1	0.25	40	5.5		2.5	2.1	2	0.85	● 111468				
* 1.2	0.25	40	5.5		2.5	2.1	2	0.95	● 111469				
* 1.4	0.3	40	7		2.5	2.1	2	1.1	● 111470				
* 1.5	0.3	40	7		2.5	2.1	2	1.2	● 111471				
* 1.6	0.35	40	8		2.5	2.1	2	1.25	● 101454				
* 1.7	0.35	40	8		2.5	2.1	2	1.35	● 101455				
* 1.8	0.35	40	8		2.5	2.1	2	1.45	● 101456				
* 2	0.4	45	8		2.8	2.1	2	1.6	● 101458	● 101536	● 101528	● 152900	
* 2.2	0.45	45	9		2.8	2.1	2	1.75	● 101459				
* 2.3	0.4	45	9		2.8	2.1	2	1.9	● 101460				
2.5	0.45	50	10		2.8	2.1	3	2.05	● 101483	● 101545	● 101530	● 101522	
2.6	0.45	50	10		2.8	2.1	3	2.15	● 101484				
3	0.5	56	12	18	3.5	2.7	3	2.5	● 101485	● 101546	● 101531	● 101523	
3.5	0.6	56	13	20	4	3	3	2.9	● 101491	● 101547			
4	0.7	63	14	21	4.5	3.4	3	3.3	● 101495	● 101548	● 101532	● 101524	
5	0.8	70	15	25	6	4.9	3	4.2	● 101499	● 101549	● 101533	● 101525	
6	1	80	17	30	6	4.9	3	5	● 101503	● 101550	● 101534	● 101526	
8	1.25	90	20	35	8	6.2	3	6.8	● 101506	● 101551	● 101535	● 101527	
10	1.5	100	22	39	10	8	3	8.5	● 101481	● 101544	● 101529	● 101521	
<p>* N320-3 / N320V-3 N320TN-3 / N320TC-3 </p>										 ≤ M1.5			

									N420-4	N420V-4	N420TN-4	N420TC-4
N420-4												
N420V-4		V										
N420TN-4		TiN										
N420TC-4		TiCN										
$\emptyset d_1$ M	P mm	$l_1$ mm	$l_2$ mm	$d_2$ mm	a mm				ID	ID	ID	ID
3	0.5	56	12	2.2	1.8	3	2.5	● 102119	● 143418			
4	0.7	63	14	2.8	2.1	3	3.3	● 102146	● 102279			
5	0.8	70	15	3.5	2.7	3	4.2	● 102171	● 102280	● 146297		
6	1	80	17	4.5	3.4	3	5	● 102182	● 102282	● 147439		
7	1	80	17	5.5	4.3	3	6	● 102189	● 144713			
8	1.25	90	20	6	4.9	3	6.8	● 102195	● 102285	● 102251	● 102233	
9	1.25	90	20	7	5.5	3	7.8	● 102202				
10	1.5	100	22	7	5.5	3	8.5	● 102061	● 102263	● 102240	● 102228	
11	1.5	100	19	8	6.2	3	9.5	● 162770				
12	1.75	110	24	9	7	3	10.2	● 102072	● 102265	● 102243	● 102229	
14	2	110	28	11	9	3	12	● 102081	● 102267	● 102245		
16	2	110	30	12	9	3	14	● 102090	● 102269	● 102247	● 102231	
18	2.5	125	33	14	11	3	15.5	● 102097	● 102271			
20	2.5	140	36	16	12	3	17.5	● 102101	● 102273	● 102248	● 102232	
22	2.5	140	36	18	14.5	3	19.5	● 102106	● 102275			
24	3	160	39	18	14.5	4	21	● 102110	● 102278	● 144220	● 163736	
27	3	160	42	20	16	4	24	● 102117	● 143856			
30	3.5	180	45	22	18	4	26.5	● 102124	● 105124			
33	3.5	180	48	25	20	4	29.5	● 102130	● 146968			
36	4	200	51	28	22	4	32	● 102137	● 143430			
39	4	200	55	32	24	4	35	● 102144	● 158724			
42	4.5	200	55	32	24	4	37.5	● 102158	● 143107			
45	4.5	220	59	36	29	4	40.5	● 110225	● 159565			
48	5	250	63	36	29	4	43	● 110226	● 157517			
56	5.5	280	71	45	35	5	50.5	● 110229	● 158178			

										N320-4	N320-4 LH	N320V-4 LH		
										<p><b>N320-4</b>  </p> <p><b>N320-4 LH</b>  <b>LH</b> </p> <p><b>N320V-4 LH</b>  <b>V</b> <b>LH</b> </p>				
														
														
														
Ø d <sub>1</sub> M	P mm	l <sub>1</sub> mm	l <sub>2</sub> mm	l <sub>3</sub> mm	d <sub>2</sub> mm	a mm				ID	ID	ID		
* 2	0.4	45	8		2.8	2.1	2	1.6	●	162503	●	111472	●	162771
2.5	0.45	50	10		2.8	2.1	3	2.05	●	159345				
3	0.5	56	12	18	3.5	2.7	3	2.5	●	101487	●	111473	●	162772
4	0.7	63	14	21	4.5	3.4	3	3.3	●	101493	●	111474	●	162773
5	0.8	70	15	25	6	4.9	3	4.2	●	101497	●	111475	●	162774
6	1	80	17	30	6	4.9	3	5	●	101501	●	111476	●	162775
10	1.5	100	22	39	10	8	3	8.5	★	146484				

\* N320-3 / N320V-3



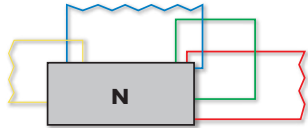



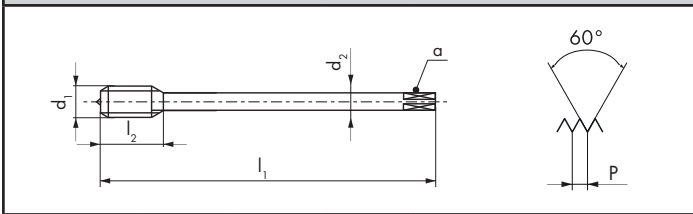
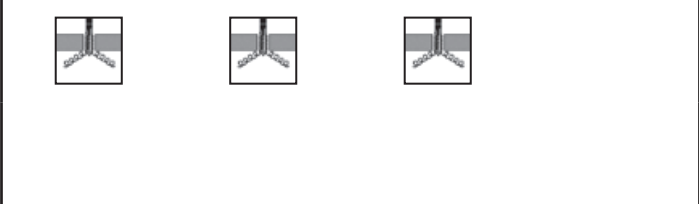







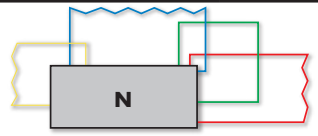





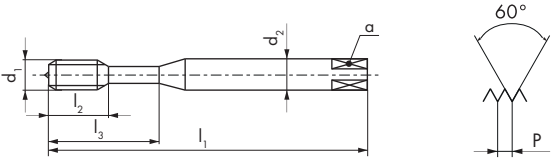

<b>N420-4</b>			62 63 64 72 73 74 81 91
<b>N420-4 LH</b>		LH	62 63 64 72 73 74 81 91
<b>N420V-4 LH</b>		V LH	11 12 31 32

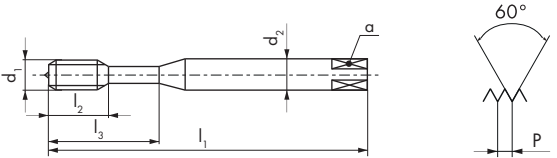

<b>ISO 1 4H</b>	<b>ISO 2 6H</b>	<b>ISO 2 6H</b>

$\emptyset d_1$ M	P mm	$l_1$ mm	$l_2$ mm	$d_2$ mm	a mm			ID	ID	ID
8	1.25	90	20	6	4.9	3	$\pm 6.8$	● 102193	● 102198	● 142621
10	1.5	100	22	7	5.5	3	8.5	● 102059	● 102064	● 143287
12	1.75	110	24	9	7	3	10.2	● 102070	● 102040	● 146583
14	2	110	28	11	9	3	12		● 102084	● 146563
16	2	110	30	12	9	3	14		● 102093	● 143108
20	2.5	140	36	16	12	3	17.5		● 102103	● 145579
24	3	160	39	18	14.5	4	21		● 111493	● 145578

$\Delta$  ISO 1 4H = 6.70





										N320-4	N320V-4	N320-4	N320-4		
<p><b>N320-4</b>  <span style="margin-left: 20px;">62 63 64 72 73 74</span>  <span style="margin-left: 20px;">81 91</span></p> <p><b>N320V-4</b>   <span style="margin-left: 20px;">11 12 31 32</span></p>										   					
										   					
										   					
Ø d <sub>1</sub> M	P mm	l <sub>1</sub> mm	l <sub>2</sub> mm	l <sub>3</sub> mm	d <sub>2</sub> mm	a mm			ID	6H + mm	ID	6H + mm	ID	6H + mm	ID
* 2	0.4	45	8		2.8	2.1	2	1.6	● 101457	0.019	● 143584	0.019			
2.5	0.45	50	10		2.8	2.1	3	2.05	● 101482	0.020	● 150522	0.020			
3	0.5	56	12	18	3.5	2.7	3	2.5	● 101486	0.020	● 143116	0.020	● 101489	0.036	● 101488
3.5	0.6	56	13	20	4	3	3	2.95	● 101490	0.021					
4	0.7	63	14	21	4.5	3.4	3	3.35	● 101494	0.022	● 143087	0.022	● 101496	0.041	● 111522
5	0.8	70	15	25	6	4.9	3	4.25	● 101498	0.024	● 143088	0.024	● 101500	0.044	● 111523
6	1	80	17	30	6	4.9	3	5	● 101502	0.026	● 143089	0.026	● 101504	0.050	● 111524
8	1.25	90	20	35	8	6.2	3	6.8	● 101505	0.028	● 143604	0.028			

\* N320-3 / N320V-3 

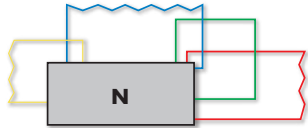







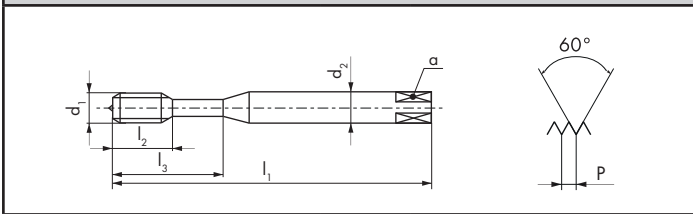
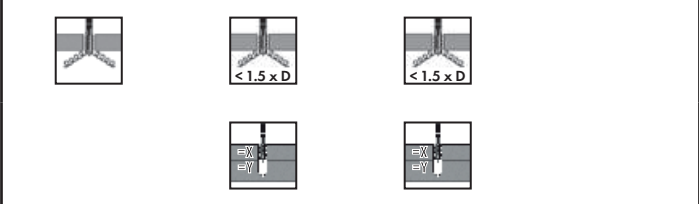

								N420-4	N420V-4	N420-4	N420-4								
								N420-4											
N420V-4																			
$\emptyset d_1$ M	P mm	$l_1$ mm	$l_2$ mm	$d_2$ mm	a mm			6H	ID	6H + mm	ID	6H + mm	ID	6H + mm	ID				
8	1.25	90	20	6	4.9	3		6.8	• 102194	0.028	• 145246	0.028	• 102199	0.052	• 102196				
10	1.5	100	22	7	5.5	3		8.5	• 102060	0.032	• 143726	0.032	• 102065	0.060	• 102062				
12	1.75	110	24	9	7	3		10.3	• 102071	0.034	• 145655	0.034	• 102076	0.066	• 102073				
16	2	110	30	12	9	3		14	• 135531	0.038	• 162795	0.038	• 102094	0.072	• 102091				





<b>N321-4</b>			61 62 63 64 71 72 73 74 81 91
<b>N330-4</b>			63 72
<b>N330V-4</b>			11 12



Ø d1 M	P mm	l1 mm	l2 mm	l3 mm	d2 mm	a mm			ID	ID	ID
* 1	0.25	40	5.5		2.5	2.1	2	0.75		● 101558	
* 1.1	0.25	40	5.5		2.5	2.1	2	0.85		★ 101559	
* 1.2	0.25	40	5.5		2.5	2.1	2	0.95		● 101560	
* 1.4	0.3	40	7		2.5	2.1	2	1.1		● 101561	
* 1.6	0.35	40	8		2.5	2.1	2	1.25		● 101562	● 151246
* 2	0.4	45	8		2.8	2.1	2	1.6	● 101552	● 105125	● 101572
2.5	0.45	50	10		2.8	2.1	* 3	2.05	● 101553	● 101565	● 101573
3	0.5	56	12	18	3.5	2.7	* 3	2.5	● 101555	● 101567	● 101574
3.5	0.6	56	13	20	4	3	2	2.9		● 101568	
4	0.7	63	14	21	4.5	3.4	3	3.3	● 101557	● 101569	● 101576
5	0.8	70	15	25	6	4.9	3	4.2		● 101570	● 101577
6	1	80	17	30	6	4.9	3	5		● 101571	● 101578

\* N321-3 / N330-3 / N330V-3 

\* N330-4 =  2  
\* N330V-4 =  2

≤ M1.5 

								N420-4	N421-4	N430-4	N430V-4	
N420-4												
N421-4												
N430-4												
N430V-4												
$\frac{\text{Ø } d_1}{M}$	P	$l_1$	$l_2$	$d_2$	a			ID	ID	ID	ID	
4	0.7	63	14	2.8	2.1	3	3.3		● 102293			
5	0.8	70	15	3.5	2.7	3	4.2		● 102294			
6	1	80	17	4.5	3.4	3	5		● 102295			
8	1.25	90	20	6	4.9	3	6.8	● 102197	● 102296	● 102301	● 102306	
10	1.5	100	22	7	5.5	3	8.5	● 102063	● 102286	● 102297	● 102302	
12	1.75	110	24	9	7	3	10.2	● 102074	● 102287	● 102298	● 102303	
16	2	110	30	12	9	3	14	● 102092	● 102289			

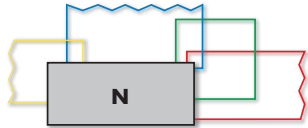

N350-3



62 63 64 72 73 74  
81 91

N350V-3





11 12 31 32

N350-3

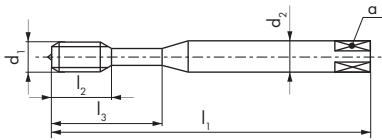
N350V-3



Ø d <sub>1</sub> M	P mm	l <sub>1</sub> mm	l <sub>2</sub> mm	l <sub>3</sub> mm	d <sub>2</sub> mm	a mm		
2	0.4	45	8		2.8	2.1	2	1.6
2.3	0.4	45	9		2.8	2.1	2	1.9
2.5	0.45	50	10		2.8	2.1	2	2.05
2.6	0.45	50	10		2.8	2.1	2	2.15
3	0.5	56	12	18	3.5	2.7	2	2.5
3.5	0.6	56	13	20	4	3	2	2.9
4	0.7	63	14	21	4.5	3.4	2	3.3
5	0.8	70	15	25	6	4.9	3	4.2
6	1	80	17	30	6	4.9	3	5
8	1.25	90	20	35	8	6.2	3	6.8
10	1.5	100	22	39	10	8	3	8.5

ID

ID

● 101580	● 101593
● 101581	
● 101582	● 101594
● 101583	
● 101584	● 101595
● 101585	
● 101587	● 101596
● 101589	● 101597
● 101591	● 101598
● 101592	● 146810
● 101579	● 147217

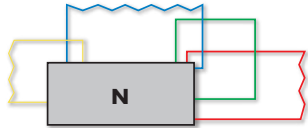

**N450-3**

R15

62 63 64 72 73 74  
81 91

**N450V-3**

R15

V

11 12 31 32

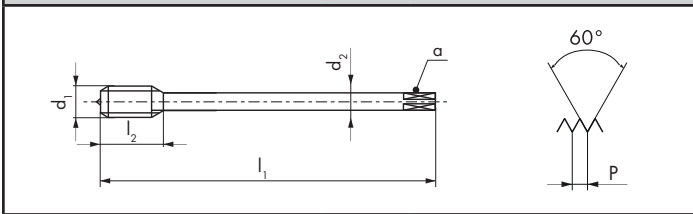







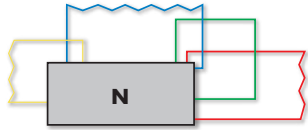







ISO 2 6H	ISO 2 6H

$\emptyset d_1$ M	P mm	$l_1$ mm	$l_2$ mm	$d_2$ mm	a mm			ID	ID
8	1.25	90	20	6	4.9	3	6.8	● 102327	● 102334
10	1.5	100	22	7	5.5	3	8.5	● 102314	● 102329
12	1.75	110	24	9	7	3	10.2	● 102317	● 102330
14	2	110	28	11	9	3	12	● 102319	● 145487
16	2	110	30	12	9	3	14	● 102321	● 102331
20	2.5	140	36	16	12	4	17.5	● 102324	● 102332
24	3	160	39	18	14.5	4	21	● 102325	● 102333









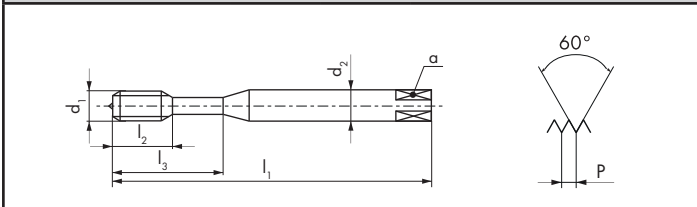





<b>N360-3</b>		63 72 73 74 81 91
<b>N360V-3</b>	 	11 12 32
<b>N360TN-3</b>	 	11 12 13 14 32
<b>N360TC-3</b>	 	11 12 13 14 21 31 32 62 64 73 74 82 83

N360-3	N360V-3	N360TN-3	N360TC-3
			
			







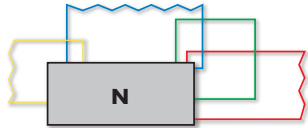





Ø d <sub>1</sub> M	P mm	l <sub>1</sub> mm	l <sub>2</sub> mm	l <sub>3</sub> mm	d <sub>2</sub> mm	a mm			ID	ID	ID	ID
2	0.4	45	7		2.8	2.1	2	1.6	● 101618	● 101708	● 101697	● 146842
2.2	0.45	45	8		2.8	2.1	2	1.75	● 101619			
2.3	0.4	45	8		2.8	2.1	2	1.9	● 101620			
2.5	0.45	50	9		2.8	2.1	2	2.05	● 101622	● 101709	● 101698	● 101689
2.6	0.45	50	9		2.8	2.1	2	2.15	● 101623	● 101710		
3	0.5	56	5.5	18	3.5	2.7	3	2.5	● 101626	● 101711	● 101699	● 101690
3.5	0.6	56	6.5	20	4	3	3	2.9	● 101630	● 142625		
4	0.7	63	7.5	21	4.5	3.4	3	3.3	● 101635	● 101713	● 101700	● 101691
4.5	0.75	70	9	25	6	4.9	3	3.75	● 101639			
5	0.8	70	9	25	6	4.9	3	4.2	● 101644	● 101715	● 101701	● 101692
6	1	80	11	30	6	4.9	3	5	● 101652	● 101717	● 101703	● 101693
7	1	80	11	30	7	5.5	3	6	● 101656	● 101718		
8	1.25	90	12.5	35	8	6.2	3	6.8	● 101663	● 101721	● 101705	● 101694
9	1.25	90	12.5	35	9	7	3	7.8	● 101668			
10	1.5	100	14	39	10	8	3	8.5	● 101612	● 101707	● 101696	● 101688









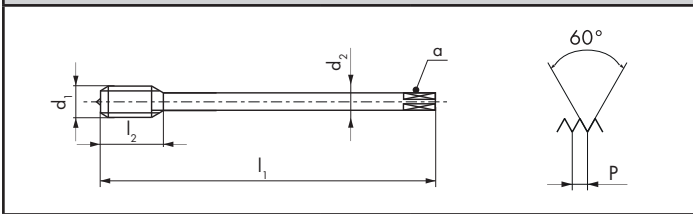

N460-3	N460V-3	N460TN-3	N460TC-3
--------	---------	----------	----------



<b>N460-3</b>		63 72 73 74 81 91
<b>N460V-3</b>	 	11 12 32
<b>N460TN-3</b>	 	11 12 13 14 32
<b>N460TC-3</b>	 	11 12 13 14 21 31 32 62 64 73 74 82 83







			
---	---	---	---



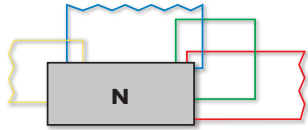





$\emptyset d_1$ M	P mm	$l_1$ mm	$l_2$ mm	$d_2$ mm	a mm			ID	ID	ID	ID
5	0.8	70	9	3.5	2.7	3	4.2	● 102410	● 102489	● 160682	
6	1	80	11	4.5	3.4	3	5	● 102411	● 102491	● 152850	
8	1.25	90	12.5	6	4.9	3	6.8	● 102412	● 102492	● 152849	
10	1.5	100	14	7	5.5	3	8.5	● 102351	● 102461	● 150242	● 158687
12	1.75	110	14	9	7	3	10.2	● 102359	● 102465	● 102449	● 102438
14	2	110	14	11	9	3	12	● 102369	● 102468	● 102451	● 111615
16	2	110	18	12	9	3	14	● 102376	● 102471	● 102453	● 102440
18	2.5	125	21	14	11	3	15.5	● 102383	● 102473		
20	2.5	140	24	16	12	4	17.5	● 102389	● 102475	● 102454	● 143280
22	2.5	140	24	18	14.5	4	19.5	● 102394	● 102477		
24	3	160	27	18	14.5	4	21	● 102398	● 102480	● 143119	● 150018
27	3	160	27	20	16	4	24	● 175423	● 102481		
30	3.5	180	30	22	18	4	26.5	● 150246	● 102482		
33	3.5	180	33	25	20	4	29.5	● 167621	● 102483		
36	4	200	36	28	22	5	32	● 143914	● 102484		
39	4	200	40	32	24	5	35	● 175424	● 102485		
42	4.5	200	40	32	24	5	37.5	● 169122	● 102486		
45	4.5	220	44	36	29	5	40.5		● 102487		
48	5	250	48	36	29	5	43		● 102488		
52	5	250	52	40	32	5	47		● 110228		
56	5.5	280	56	45	35	6	50.5		● 102490		
64	6	315	64	50	39	6	58		● 143805		



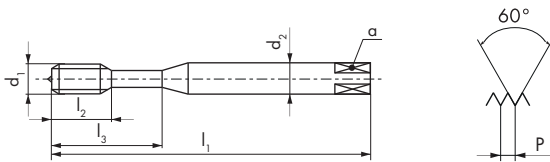

<b>N360-3 LH</b>		<b>LH</b>	<b>63 72 73 74 81 91</b>
<b>N360V-3 LH</b>		<b>V</b>	<b>LH 11 12 32</b>
<b>N360-3</b>			<b>63 72 73 74 81 91</b>
<b>N360V-3</b>		<b>V</b>	<b>11 12 32</b>

**N360-3 LH    N360V-3 LH    N360-3    N360V-3**



			
<b>ISO 2 6H</b>	<b>ISO 2 6H</b>	<b>ISO 3 6G</b>	<b>ISO 3 6G</b>

Ø d <sub>1</sub> M	P mm	l <sub>1</sub> mm	l <sub>2</sub> mm	l <sub>3</sub> mm	d <sub>2</sub> mm	a mm			ID	ID	ID <sup>6H</sup> + mm	ID <sup>6H</sup> + mm
2	0.4	45	7		2.8	2.1	2	1.6			● 101617 0.019	● 146000 0.019
2.5	0.45	50	9		2.8	2.1	2	2.05			● 101621 0.020	● 143294 0.020
3	0.5	56	5.5	18	3.5	2.7	3	2.5	● 101627	● 146811	● 101625 0.020	● 104816 0.020
3.5	0.6	56	6.5	20	4	3	3	2.95			● 101629 0.021	● 125829 0.021
4	0.7	63	7.5	21	4.5	3.4	3	3.3	● 101637	● 162540	● 101634 0.022	● 104817 0.022
5	0.8	70	9	25	6	4.9	3	4.2	● 101646	● 144003	● 101643 0.024	● 104818 0.024
6	1	80	11	30	6	4.9	3	5	● 101654	● 144004	● 101669 0.026	● 104819 0.026
8	1.25	90	12.5	35	8	6.2	3	6.8	● 101666	● 143925	● 101662 0.028	● 104820 0.028
10	1.5	100	14	39	10	8	3	8.5	● 101615	● 143587	● 101611 0.032	● 104821 0.032

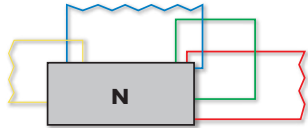

N460-3 LH    N460V-3 LH    N460-3    N460V-3

N460-3 LH          63 72 73 74 81 91

N460V-3 LH             11 12 32

N460-3       63 72 73 74 81 91

N460V-3          11 12 32

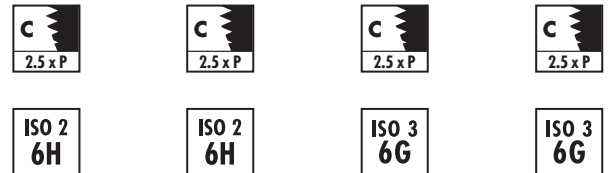
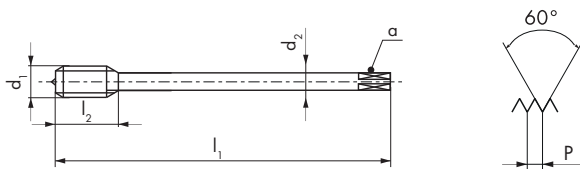

$\emptyset d_1$ M	P mm	$l_1$ mm	$l_2$ mm	$d_2$ mm	a mm			ID	ID	ID	6H + mm	ID	6H + mm
12	1.75	110	14	9	7	3	10.2	● 102362	● 146354	● 102358	0.034	● 143602	0.034
14	2	110	14	11	9	3	12			● 102368	0.038	● 144712	0.038
16	2	110	18	12	9	3	14	● 102378	● 143439	● 102375	0.038	● 150197	0.038
20	2.5	140	24	16	12	4	17.5	● 102390	● 146564	● 102388	0.042	● 145420	0.042

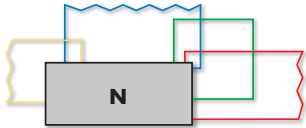

N360-3



63 72 73 74 81 91

N360V-3





11 12 32

N360-3

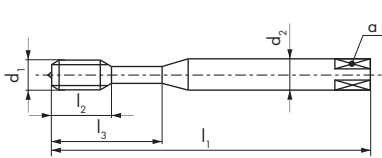

N360-3

N360V-3



Ø d <sub>1</sub> M	P mm	l <sub>1</sub> mm	l <sub>2</sub> mm	l <sub>3</sub> mm	d <sub>2</sub> mm	a mm		 6H
3	0.5	56	5.5	18	3.5	2.7	3	2.5
4	0.7	63	7.5	21	4.5	3.4	3	3.3
5	0.8	70	9	25	6	4.9	3	4.2
6	1	80	11	30	6	4.9	3	5
8	1.25	90	12.5	35	8	6.2	3	<sup>Δ</sup> 6.8
10	1.5	100	14	39	10	8	3	8.5

ID	ID 6H + mm	ID 6H + mm
● 101624	● 101628 0.036	● 144311 0.036
● 101633	● 101638 0.041	● 144192 0.041
● 101642	● 101647 0.044	● 143208 0.044
● 101651	● 101655 0.050	● 146709 0.050
● 101661	● 101667 0.052	● 146267 0.052
● 101610	● 101616 0.060	● 142547 0.060

Ø d <sub>1</sub> M	P mm	l <sub>1</sub> mm	l <sub>2</sub> mm	l <sub>3</sub> mm	d <sub>2</sub> mm	a mm		 6H +0.1
3	0.5	56	5.5	18	3.5	2.7	3	2.6
4	0.7	63	7.5	21	4.5	3.4	3	3.4
5	0.8	70	9	25	6	4.9	3	4.3
6	1	80	11	30	6	4.9	3	5.1
8	1.25	90	12.5	35	8	6.2	3	6.9
10	1.5	100	14	39	10	8	3	8.6

ID	ID
● 160847	
● 101636	● 146513
● 101645	● 146046
● 101653	● 145559
● 101664	● 143415
● 101613	● 124917





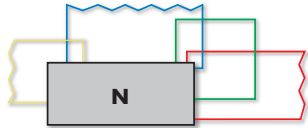



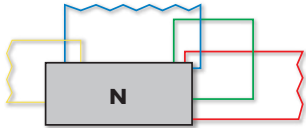









<sup>Δ</sup> ISO 1 4H = 6.70





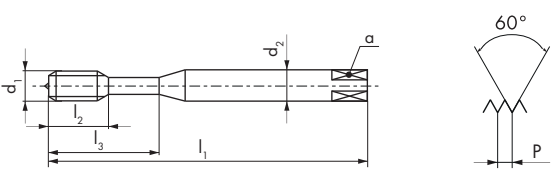





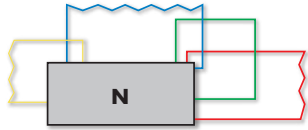













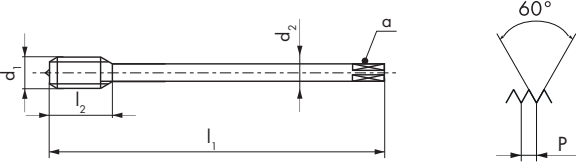

									N460-3	N460-3	N460V-3		
<p><b>N460-3</b>  63 72 73 74 81 91</p> <p><b>N460V-3</b>   11 12 32</p>													
$\emptyset d_1$	P	$l_1$	$l_2$	$d_2$	a				<b>ID</b>	<b>ID</b>	<b>ID</b>	<b>ID</b>	
M	mm	mm	mm	mm	mm					<sup>6H</sup> + mm	<sup>6H</sup> + mm	<sup>6H</sup> + mm	
12	1.75	110	14	9	7	3	10.2		* 124987	● 102363	0.066	● 142532	0.066
16	2	110	18	12	9	3	14			● 102379	0.072	● 144956	0.072
$\emptyset d_1$	P	$l_1$	$l_2$	$d_2$	a				<b>ID</b>	<b>ID</b>			
M	mm	mm	mm	mm	mm		<sup>6H</sup> +0.1						
12	1.75	110	14	9	7	3	10.3		● 102360	● 125044			
16	2	110	18	12	9	3	14.1		● 102377	● 145311			



										N360-5	N360V-5	N361-3	N362V-3
<p><b>N360-5</b>  </p> <p><b>N360V-5</b>   </p> <p><b>N361-3</b>   </p> <p><b>N362V-3</b>    </p>													
													
													
													
Ø d <sub>1</sub> M	P mm	l <sub>1</sub> mm	l <sub>2</sub> mm	l <sub>3</sub> mm	d <sub>2</sub> mm	a mm			ID	ID	ID	ID	
2	0.4	45	7		2.8	2.1	2	1.6	● 158079	● 150058			
3	0.5	56	5.5	18	3.5	2.7	3	2.5	● 104809	● 142646	● 101735		
4	0.7	63	7.5	21	4.5	3.4	3	3.3	● 104810	● 142647	● 101736	● 101741	
5	0.8	70	9	25	6	4.9	3	4.2	● 104811	● 142648	● 101737	● 101742	
6	1	80	11	30	6	4.9	3	5	● 104812	● 142649	● 101738	● 101743	
8	1.25	90	12.5	35	8	6.2	3	6.8	● 104813	● 142650	● 101739	● 101744	
10	1.5	100	14	39	10	8	3	8.5	● 104814	● 124899	● 101734	● 101740	



								N460-5	N460V-5	N461-3	N462V-3
<p><b>N460-5</b></p>  <span style="margin-left: 100px;">63 72 73 74 81 91</span>											
<p><b>N460V-5</b></p>   <span style="margin-left: 100px;">11 12 32</span>											
<p><b>N461-3</b></p>   <span style="margin-left: 100px;">61 63 71 72 73 74 81 91</span>											
<p><b>N462V-3</b></p>    <span style="margin-left: 100px;">11 12 32</span>											
								 	 	 	 
$\emptyset d_1$ M	P mm	$l_1$ mm	$l_2$ mm	$d_2$ mm	a mm			ID	ID	ID	ID
12	1.75	110	14	9	7	3	10.2	● 104815	● 142651	● 102506	● 102512
14	2	110	14	11	9	3	12				● 102513
16	2	110	18	12	9	3	14				● 102514
18	2.5	125	21	14	11	3	15.5			* 111614	● 102515
20	2.5	140	24	16	12	4	17.5				● 102516
24	3	160	27	18	14.5	4	21				● 102517
27	3	160	27	20	16	4	24				● 159244
30	3.5	180	30	22	18	4	26.5				● 143090

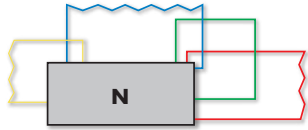

<b>N520-4</b>		62 63 64 72 73 74 81 91
<b>N520V-4</b>	V	11 12 31 32
<b>N520TN-4</b>	TiN	11 12 13 14 32

N520-4	N520V-4	N520TN-4	

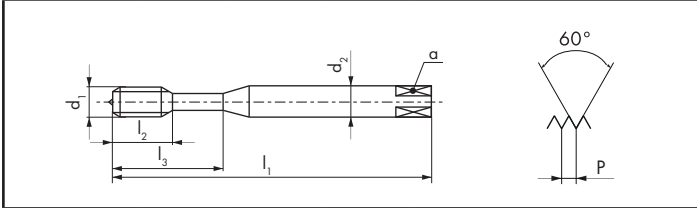

<b>ISO 2 6H</b>	<b>ISO 2 6H</b>	<b>ISO 2 6H</b>



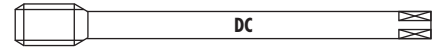

Ø d1 M	P mm	l1 mm	l2 mm	l3 mm	d2 mm	a mm			ID	ID	ID
2.5	0.45	100	10		2.8	2.1	3	2.05	● 102594	● 142623	
3	0.5	112	12	18	3.5	2.7	3	2.5	● 102595	● 143399	● 162790
4	0.7	112	14	21	4.5	3.4	3	3.3	● 102596	● 143400	● 146837
5	0.8	125	15	25	6	4.9	3	4.2	● 102597	● 142654	● 150113
6	1	125	17	30	6	4.9	3	5	● 102598	● 143137	● 148821

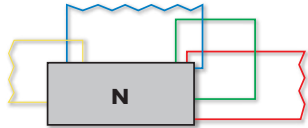

								N620-4	N620V-4	N620TN-4
N620-4			62 63 64 72 73 74 81 91							
N620V-4		V	11 12 31 32							
N620TN-4		TiN	11 12 13 14 32							
								ISO 2 6H	ISO 2 6H	ISO 2 6H
$\emptyset d_1$ M	P mm	$l_1$ mm	$l_2$ mm	$d_2$ mm	a mm			ID	ID	ID
4	0.7	112	14	2.8	2.1	3	3.3	● 102619	● 142582	● 146442
5	0.8	125	15	3.5	2.7	3	4.2	● 102620	● 142657	● 146443
6	1	125	17	4.5	3.4	3	5	● 102621	● 142658	● 144591
8	1.25	140	20	6	4.9	3	6.8	● 102622	● 143401	● 146262
10	1.5	160	22	7	5.5	3	8.5	● 102614	● 142660	● 146849
12	1.75	180	24	9	7	3	10.2	● 102615	● 143127	● 146295
14	2	180	28	11	9	3	12	● 102616	● 151905	
16	2	200	30	12	9	3	14	● 102617	● 143106	● 143574
20	2.5	224	36	16	12	3	17.5	● 102618	● 143596	● 174317











<b>N560-3</b>		63 72 73 74 81 91
<b>N560V-3</b>	 	11 12 32
<b>N560TN-3</b>	 	11 12 13 14 32

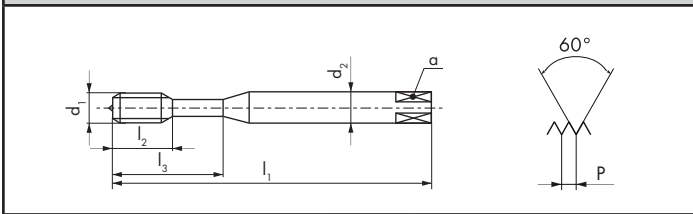

N560-3	N560V-3	N560TN-3	
--------	---------	----------	--











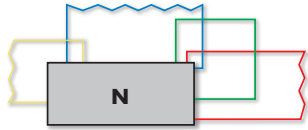
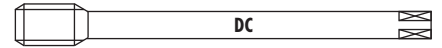











 < 2.5 x D	 < 2.5 x D	 < 2.5 x D
---	---	---

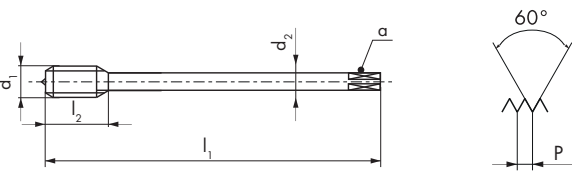

		
<b>ISO 2 6H</b>	<b>ISO 2 6H</b>	<b>ISO 2 6H</b>

Ø d1 M	P mm	l1 mm	l2 mm	l3 mm	d2 mm	a mm			ID	ID	ID
2.5	0.45	100	9		2.8	2.1	2	2.05	● 102600	● 102607	
3	0.5	112	5.5	18	3.5	2.7	3	2.5	● 102601	● 102608	● 142663
4	0.7	112	7.5	21	4.5	3.4	3	3.3	● 102602	● 102609	● 142664
5	0.8	125	9	25	6	4.9	3	4.2	● 102603	● 102610	● 142665
6	1	125	11	30	6	4.9	3	5	● 102604	● 102611	● 142666
8	1.25	140	12.5	35	8	6.2	3	6.8	● 102605	● 102612	● 142667
10	1.5	160	14	39	10	8	3	8.5	● 102599	● 102606	● 142668



								N660-3	N660V-3	N660TN-3					
<p><b>N660-3</b></p>  <span style="margin-left: 100px;">63</span> <span style="margin-left: 10px; background-color: yellow;">72</span> <span style="margin-left: 10px;">73</span> <span style="margin-left: 10px;">74</span> <span style="margin-left: 10px; background-color: yellow;">81</span> <span style="margin-left: 10px;">91</span>								  							
<p><b>N660V-3</b></p>   <span style="margin-left: 100px;">11</span> <span style="margin-left: 10px;">12</span> <span style="margin-left: 10px;">32</span>															
<p><b>N660TN-3</b></p>   <span style="margin-left: 100px;">11</span> <span style="margin-left: 10px;">12</span> <span style="margin-left: 10px;">13</span> <span style="margin-left: 10px;">14</span> <span style="margin-left: 10px;">32</span>															
								 $< 2.5 \times D$  $< 2.5 \times D$  $< 2.5 \times D$							
								  							
								  							
$\emptyset d_1$ M	P mm	$l_1$ mm	$l_2$ mm	$d_2$ mm	a mm			ID	ID	ID					
6	1	125	11	4.5	3.4	3	5	● 162792	● 115657						
8	1.25	140	12.5	6	4.9	3	6.8	● 162793	● 115544						
10	1.5	160	14	7	5.5	3	8.5	● 162794	● 135539	● 173484					
12	1.75	180	14	9	7	3	10.2	● 102623	● 102626	● 142669					
14	2	180	14	11	9	3	12	● 162253	● 147500						
16	2	200	18	12	9	3	14	● 102624	● 102627	● 142670					
20	2.5	224	24	16	12	4	17.5	● 102625	● 102628	● 178003					

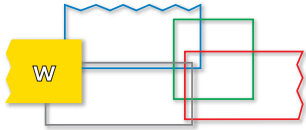
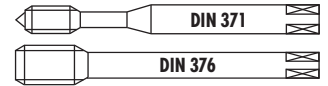

										W320-4	W420-4	W320DL-4	W420DL-4						
<div style="display: flex; justify-content: space-between;"> <div style="width: 45%;"> <p><b>W320-4</b> <b>71 72 81</b></p> <p><b>W420-4</b> <b>71 72 81</b></p> <p><b>W320DL-4</b> <b>DLC</b> <b>71 72 73</b></p> <p><b>W420DL-4</b> <b>DLC</b> <b>71 72 73</b></p> </div> <div style="width: 50%; text-align: center;"> </div> </div>																			
Ø d <sub>1</sub> M	P mm	l <sub>1</sub> mm	l <sub>2</sub> mm	l <sub>3</sub> mm	d <sub>2</sub> mm	a mm				ID	ID	ID	ID						
* 2	0.4	45	8		2.8	2.1	2	1.6		● 104612		● 176688							
2.5	0.45	50	10		2.8	2.1	2	2.05		● 104613		● 176689							
3	0.5	56	12	18	3.5	2.7	2	2.5		● 104615		● 176690							
4	0.7	63	14	21	4.5	3.4	2	3.3		● 104617		● 176691							
5	0.8	70	15	25	6	4.9	2	4.2		● 104618		● 176354							
6	1	80	17	30	6	4.9	2	5		● 104619		● 175590							
8	1.25	90	20		6	4.9	2	6.8			● 104636		● 176692						
10	1.5	100	22		7	5.5	2	8.5			● 104632		● 176693						
12	1.75	110	24		9	7	3	10.2			● 104633		● 176694						
16	2	110	30		12	9	3	14			● 104634		● 176695						

\* W320-3   
 \* W320DL-3

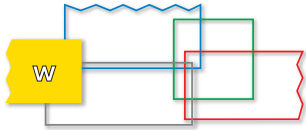

										W360-3	W460-3	W360DL-3	W460DL-3	
<p><b>W360-3</b> <b>71 72 81</b></p> <p><b>W460-3</b> <b>71 72 81</b></p> <p><b>W360DL-3</b> <b>71 72 73</b></p> <p><b>W460DL-3</b> <b>71 72 73</b></p>														
Ø d <sub>1</sub> M	P mm	l <sub>1</sub> mm	l <sub>2</sub> mm	l <sub>3</sub> mm	d <sub>2</sub> mm	a mm				ID	ID	ID	ID	
2	0.4	45	7		2.8	2.1	2	1.6	●	104625		●	176719	
2.5	0.45	50	9		2.8	2.1	2	2.05	●	104626		●	176720	
3	0.5	56	5.5	18	3.5	2.7	2	2.5	●	104627		●	176721	
4	0.7	63	7.5	21	4.5	3.4	2	3.3	●	104628		●	176722	
5	0.8	70	9	25	6	4.9	2	4.2	●	104629		●	176723	
6	1	80	11	30	6	4.9	2	5	●	104630		●	176355	
8	1.25	90	12.5	35	8	6.2	2	6.8	●	104631		●	176724	
10	1.5	100	14	39	10	8	2	8.5	●	104624		●	176725	
12	1.75	110	14		9	7	3	10.2			●	104640	●	176726
16	2	110	18		12	9	3	14			●	104641	●	176727

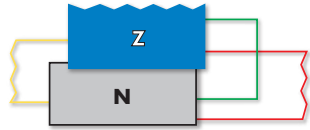
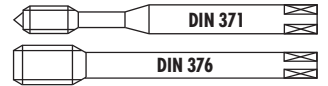

Z320V-4		V	11 12 13 21 32
Z420V-4		V	11 12 13 21 32
Z320VS-4		VS	11 12 13 14 21 22 23 32 61 63 94
Z420VS-4		VS	11 12 13 14 21 22 23 32 61 63 94

Z320V-4	Z420V-4	Z320VS-4	Z420VS-4
---------	---------	----------	----------

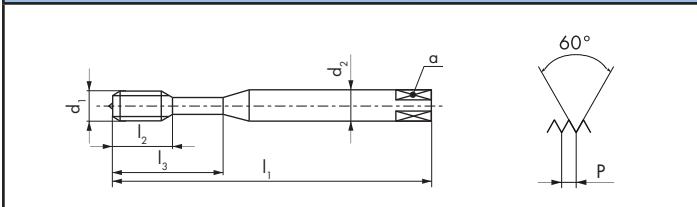
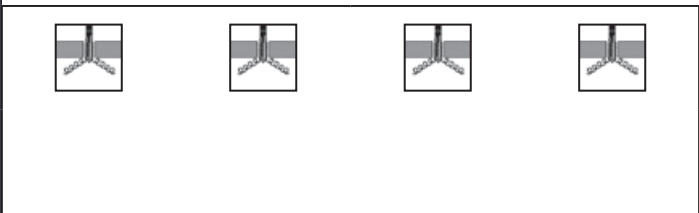

ISO 2 6H	ISO 2 6H	ISO 2 6H	ISO 2 6H

Ø d1 M	P mm	l1 mm	l2 mm	l3 mm	d2 mm	a mm			ID	ID	ID	ID
* 1.6	0.35	40	8		2.5	2.1	2	1.25	● 142671			
* 2	0.4	45	8		2.8	2.1	2	1.6	● 111613			
2.5	0.45	50	10		2.8	2.1	3	2.05	● 111455		● 143683	
2.6	0.45	50	10		2.8	2.1	3	2.15	● 142672			
3	0.5	56	12	18	3.5	2.7	3	2.5	● 104669		● 104830	
4	0.7	63	14	21	4.5	3.4	3	3.3	● 104670		● 104831	
5	0.8	70	15	25	6	4.9	3	4.2	● 104671		● 104832	
6	1	80	17	30	6	4.9	3	5	● 104672		● 104833	
8	1.25	90	20	35	8	6.2	3	6.8	● 104673		● 104834	
10	1.5	100	22	39	10	8	3	8.5	● 104668		● 104835	
12	1.75	110	24		9	7	3	10.2		● 104723		● 104836
14	2	110	28		11	9	3	12		● 142673		● 143684
16	2	110	30		12	9	3	14		● 105068		● 111569
18	2.5	125	33		14	11	4	15.5		● 142674		
20	2.5	140	36		16	12	4	17.5		● 105069		● 111570
22	2.5	140	36		18	14.5	4	19.5		● 146003		
24	3	160	39		18	14.5	4	21		● 142675		● 150017
30	3.5	180	45		22	18	4	26.5		● 142676		

\* Z320V-3 2.5 x P



# M ISO DIN 13

≤ Ø 2.8 > Ø 2.8

PM HSSE

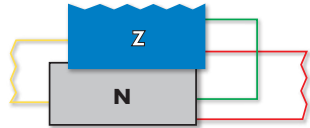
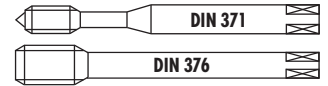

<b>Z360V-3</b>			
<b>Z362V-3</b>			
<b>Z462V-3</b>			

Z360V-3	Z362V-3	Z462V-3
---------	---------	---------



--	--	--

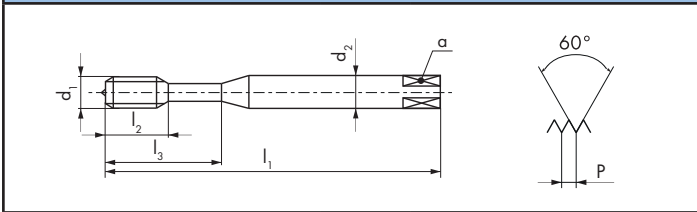

Ø d <sub>1</sub> M	P mm	l <sub>1</sub> mm	l <sub>2</sub> mm	l <sub>3</sub> mm	d <sub>2</sub> mm	a mm			ID
2	0.4	45	7		2.8	2.1	2	1.6	● 104684
2.5	0.45	50	9		2.8	2.1	2	2.05	● 104685
2.6	0.45	50	9		2.8	2.1	2	2.15	● 104686
3	0.5	56	5.5	18	3.5	2.7	3	2.5	● 104687
3.5	0.6	56	6.5	20	4	3	3	2.9	● 104688
4	0.7	63	7.5	21	4.5	3.4	3	3.3	● 104689
5	0.8	70	9	25	6	4.9	3	4.2	● 104690
6	1	80	11	30	6	4.9	3	5	● 104691
8	1.25	90	12.5	35	8	6.2	3	6.8	● 104692
10	1.5	100	14	39	10	8	3	8.5	● 104683
12	1.75	110	14		9	7	3	10.2	● 104742
14	2	110	14		11	9	3	12	● 104743
16	2	110	18		12	9	3	14	● 104744
18	2.5	125	21		14	11	3	15.5	● 104745
20	2.5	140	24		16	12	3	17.5	● 104746
22	2.5	140	24		18	14.5	3	19.5	● 104752
24	3	160	27		18	14.5	4	21	● 104747
27	3	160	27		20	16	4	24	● 104748
30	3.5	180	30		22	18	4	26.5	● 104749
36	4	200	36		28	22	4	32	● 104750
42	4.5	200	40		32	24	4	37.5	● 104751

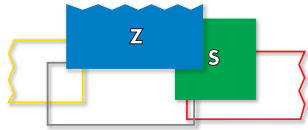

<b>Z362VS-3</b>				12 14 21 22 23 32 61 63
<b>Z370VS-3</b>				14 15 21 22 23 24 51 61
<b>Z373VS-3</b>				94
<b>Z370VS-3</b>				13 14 15 21 22 23 24 51
<b>Z373VS-3</b>				52

Z362VS-3	Z370VS-3	Z370VS-3	Z373VS-3
----------	----------	----------	----------



< 2.5 x D	< 3 x D	< 3 x D	< 3 x D
	<b>PM</b>	<b>PM</b>	<b>PM</b>

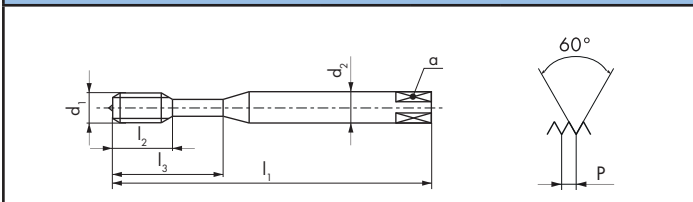

<b>6HX</b>	<b>6HX</b>	<b>4HX</b>	<b>6HX</b>

$\emptyset d_1$ M	P mm	$l_1$ mm	$l_2$ mm	$l_3$ mm	$d_2$ mm	a mm		
* 3	0.5	56	5.5	18	3.5	2.7	3	2.5
4	0.7	63	7.5	21	4.5	3.4	3	3.3
5	0.8	70	9	25	6	4.9	3	4.2
6	1	80	11	30	6	4.9	3	5
8	1.25	90	12.5	35	8	6.2	3	6.8
10	1.5	100	14	39	10	8	3	8.5

ID	ID	ID
● 111504		
● 111505		
● 111506		
● 111507		
● 111508		
● 111509		

\* **Z360VS-3**

$\emptyset d_1$ M	P mm	$l_1$ mm	$l_2$ mm	$l_3$ mm	$d_2$ h6 mm	a mm		
3	0.5	56	5.5	18	3.5(h9)	2.7	3	2.5
4	0.7	63	7.5	21	4.5(h9)	3.4	3	3.3
5	0.8	70	9	25	6	4.9	3	4.2
6	1	80	11	30	6	4.9	3	5
8	1.25	90	12.5	35	8	6.2	3	$\Delta$ 6.8
10	1.5	100	14	39	10	8	3	8.5

ID	ID	ID
● 162776	● 165324	● 165236
● 162777	● 165325	● 165237
● 162778	● 165326	● 165238
● 162779	● 165327	● 165239
● 162780	● 165328	● 165240
● 162781	● 165438	● 165241

$\Delta$  **4HX** = 6.7

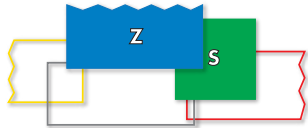

Z462VS-3

Z470VS-3

Z473VS-3

Z462VS-3



Z470VS-3



Z473VS-3



Z470VS-3



Z473VS-3



PM

PM

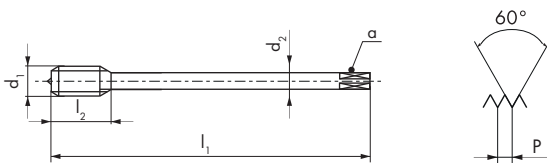

6HX

6HX

6HX

Ø d <sub>1</sub> M	P mm	l <sub>1</sub> mm	l <sub>2</sub> mm	d <sub>2</sub> mm	a mm			ID
12	1.75	110	14	9	7	4	10.2	● 111510
14	2	110	14	11	9	4	12	★ 148169
16	2	110	18	12	9	4	14	● 111511
20	2.5	140	24	16	12	4	17.5	● 111512
24	3	160	27	18	14.5	4	21	★ 111620

Ø d <sub>1</sub> M	P mm	l <sub>1</sub> mm	l <sub>2</sub> mm	d <sub>2</sub> h6 mm	a mm			ID	ID
12	1.75	110	14	* 10	* 8	4	10.2	● 162782	● 165242
14	2	110	14	* 12	* 9	4	12	● 162783	
16	2	110	18	12	9	4	14	● 162784	● 165244
18	2.5	125	21	14	11	4	15.5	● 170643	
20	2.5	140	24	16	12	4	17.5	● 162785	● 165234
22	2.5	140	24	16	12	4	19.5	● 175190	
24	3	160	27	16	12	4	21	● 162786	● 165235

\* Norme DC / \* DC Norm/ \* Norma DC

# ZX AMPCO®

## ALU-BRONZE-LEGIERUNGEN

## ALU-BRONZE-ALLOYS



**ZX - DC-Maschinengewindebohrer mit  
speziell angepasster Schneidengeometrie**

**Für Durchgangs- und Sacklöcher < 1.5 x D**

**Optimal**  
für AMPCO® 21 / 22  
Brinellhärte HB > 280 - < 330

**Geeignet**  
für AMPCO® 18  
Brinellhärte HB < 420

**Geeignet**  
für AMPCO® 25 / 26  
Brinellhärte HB < 420

**Empfehlung**  
Für AMPCO® 25 / 26: Kernlochdurchmesser + 0.2 mm

**Weitere AMPCO® Bearbeitungsoptionen:**

**Optimal**  
Für Durchgangslöcher

**DC-Maschinengewindebohrer Typ H320-4 / H420-4  
für AMPCO® 18**  
Brinellhärte HB < 200

**Optimal**  
Für Durchgangs- und Sacklöcher < 2 x D  
für AMPCO® 25 / 26  
Brinellhärte HB > 380 - < 420  
Schmierung: Schneidöl / Emulsion

**DC-VHM-GewindEFRÄSER Typ GF6165VS**  
Schnittgeschwindigkeit Vc: 30 - 50 m/min  
Fräsvorschub fz: 0.01 - 0.05 mm/Zahn

**Optimal**  
Für Durchgangs- und Sacklöcher < 4 x D  
für AMPCO® 25 / 26  
Brinellhärte HB > 380 - < 420  
Schmierung: Schneidöl / Emulsion

**DC-VHM-Gewindewirbler  
Typ GW301.VS / GWi306.VS**  
Schnittgeschwindigkeit Vc: 30 - 50 m/min  
Fräsvorschub fz: 0.01 - 0.08 mm/Zahn

**ZX - DC machine taps with specially  
adapted cutting geometry**

**For through and blind holes < 1.5 x D**

**Optimal**  
for AMPCO® 21 / 22  
Hardness Brinell HB > 280 - < 330

**Suitable**  
for AMPCO® 18  
Hardness Brinell HB < 420

**Suitable**  
for AMPCO® 25 / 26  
Hardness Brinell HB < 420

**Recommendation**  
For AMPCO® 25 / 26: Core hole diameter + 0.2 mm

**Alternative AMPCO® threading solutions:**

**Optimal**  
For through holes

**DC machine taps type H320-4 / H420-4  
for AMPCO® 18**  
Hardness Brinell HB < 200

**Optimal**  
For through and blind holes < 2 x D  
for AMPCO® 25 / 26  
Hardness Brinell HB > 380 - < 420  
Lubricant: cutting oil / emulsion

**DC solid carbide thread milling cutter type GF6165VS**  
Cutting speed Vc: 30 - 50 m/min  
Feed rate fz: 0.01 - 0.05 mm/tooth

**Optimal**  
For through and blind holes < 4 x D  
for AMPCO® 25 / 26  
Hardness Brinell HB > 380 - < 420  
Lubricant: cutting oil / emulsion

**DC solid carbide thread whirl cutter  
type GW301.VS / GWi306.VS**  
Cutting speed Vc: 30 - 50 m/min  
Feed rate fz: 0.01 - 0.08 mm/tooth

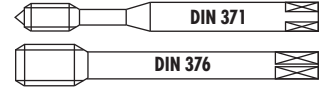

## ZX

ZX320-4



AMPCO®  
21 22

ZX420-4



AMPCO®  
21 22

ZX320-4



AMPCO®  
18  
25 26

ZX420-4



AMPCO®  
18  
25 26

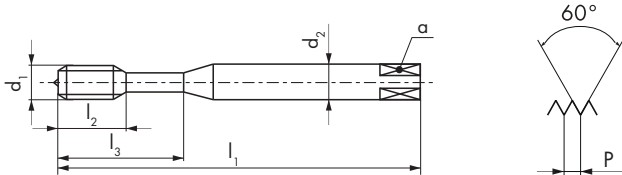

ZX320-4

ZX420-4



NEW



NEW



< 1.5 x D



< 1.5 x D



B  
4 x P



B  
4 x P

6HX

6HX

Ø d <sub>1</sub> M	P mm	l <sub>1</sub> mm	l <sub>2</sub> mm	l <sub>3</sub> mm	d <sub>2</sub> mm	a mm		
4	0.7	63	14	21	4.5	3.4	3	* 3.3
5	0.8	70	15	25	6	4.9	3	* 4.2
6	1	80	17	30	6	4.9	3	* 5
8	1.25	90	20	35	8	6.2	3	* 6.8
10	1.5	100	22	39	10	8	3	* 8.5

ID

- 143599
- 145458
- 110232
- 110233
- 124905

Ø d <sub>1</sub> M	P mm	l <sub>1</sub> mm	l <sub>2</sub> mm	d <sub>2</sub> mm	a mm		
12	1.75	110	24	9	7	3	* 10.2
16	2	110	30	12	9	3	* 14

ID

- 110208
- 110207

\*Ampco® 25 / Ampco® 26 + 0.2 mm

### ANWENDUNGSTABELLE FÜR ALU-BRONZE-LEGIERUNGEN APPLICATION CHART FOR ALU-BRONZE-ALLOYS

Werkstoffbezeichnung Material designation	Brinellhärte Hardness Brinell (HB)	Schnittgeschwindigkeit Cutting speed V <sub>c</sub> (m/min) Guide Line
AMPCO® 18	< 290	6 - 10
AMPCO® 21	> 280 - < 330	2 - 3
AMPCO® 22	> 280 - < 330	2 - 3
AMPCO® 25	< 420	2 - 3
AMPCO® 26	< 420	2 - 3

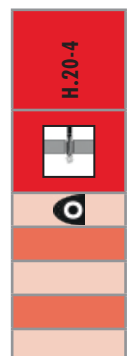

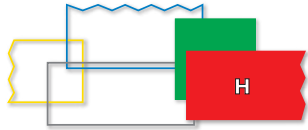

H320-4



15 16 62 64 82

H320TC-4





TiCN

15 16 24 31 82 83  
92 93

H320-4

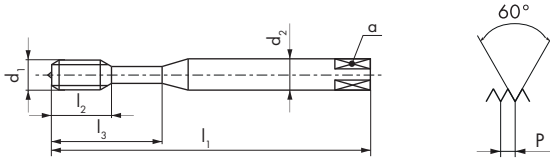



H320TC-4



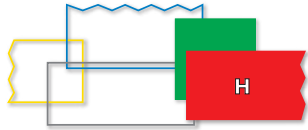

$\emptyset d_1$ M	P mm	$l_1$ mm	$l_2$ mm	$l_3$ mm	$d_2$ mm	a mm			ID	ID
2	0.4	45	8		2.8	2.1	2	1.6	● 101206	● 151836
2.2	0.45	45	9		2.8	2.1	2	1.75	● 111801	
2.5	0.45	50	10		2.8	2.1	3	2.05	● 101207	● 148603
3	0.5	56	12	18	3.5	2.7	3	2.5	● 101209	● 111836
3.5	0.6	56	13	20	4	3	3	2.9	● 101210	
4	0.7	63	14	21	4.5	3.4	3	3.3	● 101211	● 111502
4.5	0.75	70	15	25	6	4.9	3	3.75	● 101212	
5	0.8	70	15	25	6	4.9	3	4.2	● 101213	● 111458
6	1	80	17	30	6	4.9	3	5	● 101215	● 111456
8	1.25	90	20	35	8	6.2	3	6.8	● 101218	● 111453
10	1.5	100	22	39	10	8	3	8.5	● 101205	● 110911





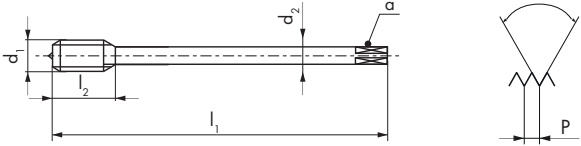

	H420-4	H420TC-4		
H420-4				
H420TC-4		TiCN		



		
	ISO 2 6H	ISO 2 6H

Ø d <sub>1</sub> M	P mm	l <sub>1</sub> mm	l <sub>2</sub> mm	d <sub>2</sub> mm	a mm			ID	ID
12	1.75	110	24	9	7	4	10.2	● 101275	● 110912
14	2	110	28	11	9	4	12	● 101277	● 145461
16	2	110	30	12	9	4	14	● 101279	● 111612
18	2.5	125	33	14	11	4	15.5	● 101281	
20	2.5	140	36	16	12	4	17.5	● 101284	● 144606
22	2.5	140	36	18	14.5	4	19.5	● 157752	
24	3	160	39	18	14.5	4	21	● 101286	● 143588
27	3	160	42	20	16	4	24	● 101287	
30	3.5	180	45	22	18	4	26.5	● 101288	
36	4	200	51	28	22	4	32	● 101289	

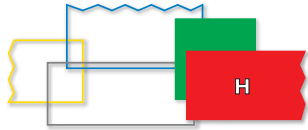

H350-3



15 16 62 64 82

H350TC-3



15 16 24 31 82 83  
92 93

H350-3

H350-3

H350TC-3

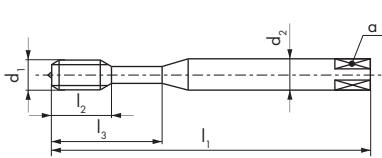

$\emptyset d_1$ M	P mm	$l_1$ mm	$l_2$ mm	$l_3$ mm	$d_2$ mm	a mm			ID	ID	6H + mm	ID
2	0.4	45	7		2.8	2.1	2	1.6	● 101238			● 146451
2.5	0.45	50	9		2.8	2.1	3	2.05	● 101239			● 144957
3	0.5	56	5.5	18	3.5	2.7	3	2.5	● 101242	● 101241	0.020	● 111835
3.5	0.6	56	6.5	20	4	3	3	2.9	● 101243			
4	0.7	63	7.5	21	4.5	3.4	3	3.3	● 101245	● 101244	0.022	● 111607
4.5	0.75	70	9	25	6	4.9	3	3.75	● 101246			
5	0.8	70	9	25	6	4.9	3	4.2	● 101248	● 101247	0.024	● 111610
6	1	80	11	30	6	4.9	3	5	● 101251	● 101250	0.026	● 111500
8	1.25	90	12.5	35	8	6.2	3	6.8	● 101255	● 101254	0.028	● 110963
10	1.5	100	14	39	10	8	3	8.5	● 101237	● 101236	0.032	● 111454

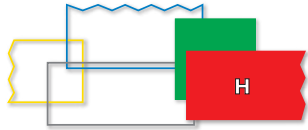

H450-3



15 16 62 64 82

H450TC-3





15 16 24 31 82 83  
92 93

H450-3

H450-3

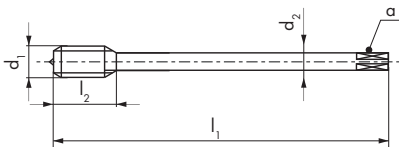
H450TC-3



Ø d <sub>1</sub> M	P mm	l <sub>1</sub> mm	l <sub>2</sub> mm	d <sub>2</sub> mm	a mm		
12	1.75	110	14	9	7	4	10.2
14	2	110	14	11	9	4	12
16	2	110	18	12	9	4	14
18	2.5	125	21	14	11	4	15.5
20	2.5	140	24	16	12	4	17.5
22	2.5	140	24	18	14.5	4	19.5
24	3	160	27	18	14.5	4	21
27	3	160	27	20	16	4	24
30	3.5	180	30	22	18	4	26.5
36	4	200	36	28	22	4	32
42	4.5	200	40	32	24	4	37.5

ID

ID

6H  
+ mm

ID

● 101305	★ 101304	0.034	● 111501
● 101307			● 146151
● 101309			● 111605
● 101311			
● 101313			● 144986
● 101315			
● 101318			● 144987
● 101320			
● 101323			
● 101324			
● 101325			

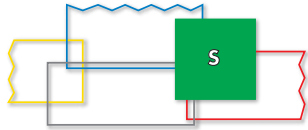
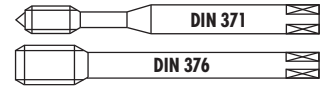

S320VS-4



13 15 16 22 23 24  
52

S420VS-4



13 15 16 22 23 24  
52

S320VS-4

S320VS-4

S420VS-4

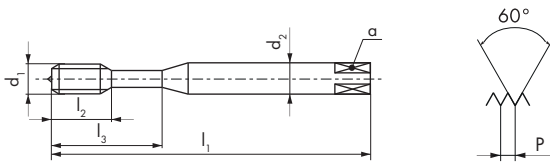
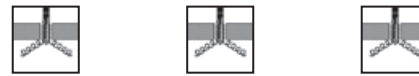

6HX

4HX

6HX

$\emptyset d_1$ M	P mm	$l_1$ mm	$l_2$ mm	$l_3$ mm	$d_2$ mm	a mm			ID	ID	ID
3	0.5	56	12	18	3.5	2.7	3	2.5	● 111596	* 165318	
4	0.7	63	14	21	4.5	3.4	3	3.3	● 111597	* 165319	
5	0.8	70	15	25	6	4.9	3	4.2	● 111598	* 165320	
6	1	80	17	30	6	4.9	3	5	● 111599	* 165321	
8	1.25	90	20	35	8	6.2	3	$\Delta$ 6.8	● 111600	* 165322	
10	1.5	100	22	39	10	8	3	8.5	● 111601	* 165323	
12	1.75	110	24		9	7	4	10.2			● 111602
16	2	110	30		12	9	4	14			● 111603
20	2.5	140	36		16	12	4	17.5			● 111604

$\Delta$  4HX = 6.7

# M

## ISO DIN 13

PM

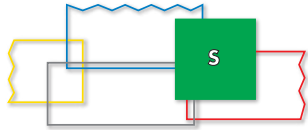
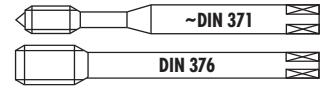

<b>S360VS-3</b>								
<b>S460VS-3</b>								



# aero

**SA390-3**

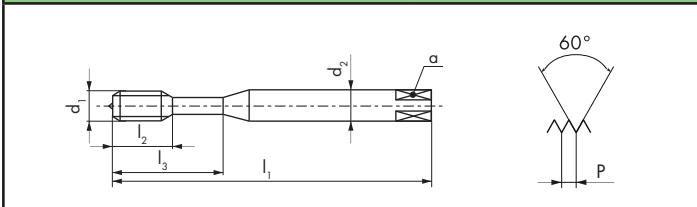
<b>6HX</b>	<b>6HX</b>	<b>4HX</b>	<b>6HX</b>

$\emptyset d_1$ M	P mm	$l_1$ mm	$l_2$ mm	$l_3$ mm	$d_2$ mm	a mm		
3	0.5	56	5.5	18	3.5	2.7	3	2.5
4	0.7	63	7.5	21	4.5	3.4	3	3.3
5	0.8	70	9	25	6	4.9	3	4.2
6	1	80	11	30	6	4.9	3	5
8	1.25	90	12.5	35	8	6.2	3	6.8
10	1.5	100	14	39	10	8	3	8.5
12	1.75	110	14		9	7	4	10.2
14	2	110	14		11	9	4	12
16	2	110	18		12	9	4	14
20	2.5	140	24		16	12	4	17.5
24	3	160	27		18	14.5	4	21

ID	ID
● 111513	
● 111514	
● 111515	
● 111516	
● 111517	
● 111518	
	● 111519
	* 148171
	● 111520
	● 111521
	● 111606

$\emptyset d_1$ M	P mm	$l_1$ mm	$l_2$ mm	$d_2$ mm	a mm		
4	0.7	63	14	4.5	3.4	3	3.3
5	0.8	70	15	6	4.9	3	4.2
6	1	80	20	6	4.9	3	5
8	1.25	90	25	8	6.2	3	$\Delta$ 6.8
10	1.5	100	30	10	8	3	8.5
12	1.75	110	35	12	9	4	10.2
14	2	110	40	16	12	4	12

ID	ID
● 149673	● 149674
● 149693	● 149694
● 149707	● 149708
● 149736	● 149737
* 149754	● 149755
	● 149775
	* 149792

$\Delta$  **4HX** = 6.7

## aero

SA320-4



15 16 52 64

SA350-3



15 16 52 64

TL320VS-4



41 42

TL351VS-3



41 42

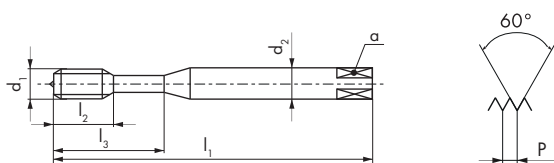

SA320-4

SA350-3

TL320VS-4

TL351VS-3



4HX

4HX

4HX

4HX

$\emptyset d_1$ M	P mm	$l_1$ mm	$l_2$ mm	$l_3$ mm	$d_2$ mm	a mm		
3	0.5	56	12		3.5	2.7	3	2.5
4	0.7	63	14		4.5	3.4	3	3.3
5	0.8	70	15		6	4.9	3	4.2
6	1	80	15	23	6	4.9	3	5
8	1.25	90	18	29	8	6.2	3	6.7
10	1.5	100	20	33	10	8	3	8.5

ID	ID	ID	ID
● 147975	● 147987	● 152006	● 152012
● 147976	● 147988	● 152007	● 152013
● 147977	● 147989	● 152008	● 152014
● 147978	● 147990	● 152009	● 152015
● 147979	● 147991	● 152010	● 152016
● 147980	● 147992	● 152011	● 152017



















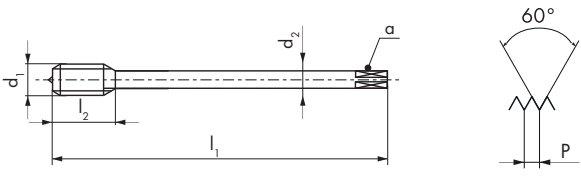
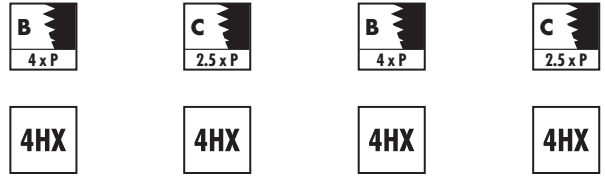

6HX	6HX	6HX	6HX
-----	-----	-----	-----

$\emptyset d_1$ M	P mm	$l_1$ mm	$l_2$ mm	$l_3$ mm	$d_2$ mm	a mm		
3	0.5	56	12		3.5	2.7	3	2.5
4	0.7	63	14		4.5	3.4	3	3.3
5	0.8	70	15		6	4.9	3	4.2
6	1	80	15	23	6	4.9	3	5
8	1.25	90	18	29	8	6.2	3	6.8
10	1.5	100	20	33	10	8	3	8.5

ID	ID	ID	ID
● 147981	● 147993	● 148001	● 148000
● 147982	● 147994	● 148003	● 148002
● 147983	● 147995	● 148007	● 148006
● 147984	● 147996	● 148011	● 148010
● 147985	● 147997	● 148020	● 148018
● 147986	● 147998	● 148027	● 148025







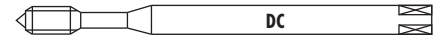
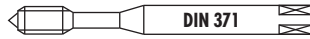

























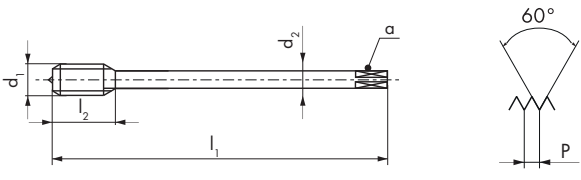

















# aero

								SA420-4	SA450-3	TL420VS-4	TL451VS-3																																																								
<b>SA420-4</b>  <b>15 16 52 64</b>																																																																			
<b>SA450-3</b>  <b>15 16 52 64</b>																																																																			
<b>TL420VS-4</b>  <b>VS</b> <b>41 42</b>																																																																			
<b>TL451VS-3</b>  <b>VS</b> <b>41 42</b>																																																																			
																																																																			
<table border="1"> <thead> <tr> <th>Ø d<sub>1</sub> M</th> <th>P mm</th> <th>l<sub>1</sub> mm</th> <th>l<sub>2</sub> mm</th> <th>d<sub>2</sub> mm</th> <th>a mm</th> <th></th> <th></th> <th>ID</th> <th>ID</th> <th>ID</th> <th>ID</th> </tr> </thead> <tbody> <tr> <td>12</td> <td>1.75</td> <td>110</td> <td>24</td> <td>9</td> <td>7</td> <td>4</td> <td>10.2</td> <td>* 148096</td> <td>* 152189</td> <td>* 152192</td> <td>* 152195</td> </tr> <tr> <td>14</td> <td>2</td> <td>110</td> <td>28</td> <td>11</td> <td>9</td> <td>4</td> <td>12</td> <td>* 152187</td> <td></td> <td></td> <td></td> </tr> <tr> <td>16</td> <td>2</td> <td>110</td> <td>30</td> <td>12</td> <td>9</td> <td>4</td> <td>14</td> <td>* 152188</td> <td></td> <td></td> <td>* 152197</td> </tr> </tbody> </table>								Ø d <sub>1</sub> M	P mm	l <sub>1</sub> mm	l <sub>2</sub> mm	d <sub>2</sub> mm	a mm			ID	ID	ID	ID	12	1.75	110	24	9	7	4	10.2	* 148096	* 152189	* 152192	* 152195	14	2	110	28	11	9	4	12	* 152187				16	2	110	30	12	9	4	14	* 152188			* 152197	<table border="1"> <thead> <tr> <th>ID</th> <th>ID</th> <th>ID</th> <th>ID</th> </tr> </thead> <tbody> <tr> <td><b>4HX</b></td> <td><b>4HX</b></td> <td><b>4HX</b></td> <td><b>4HX</b></td> </tr> </tbody> </table>				ID	ID	ID	ID	<b>4HX</b>	<b>4HX</b>	<b>4HX</b>	<b>4HX</b>
Ø d <sub>1</sub> M	P mm	l <sub>1</sub> mm	l <sub>2</sub> mm	d <sub>2</sub> mm	a mm			ID	ID	ID	ID																																																								
12	1.75	110	24	9	7	4	10.2	* 148096	* 152189	* 152192	* 152195																																																								
14	2	110	28	11	9	4	12	* 152187																																																											
16	2	110	30	12	9	4	14	* 152188			* 152197																																																								
ID	ID	ID	ID																																																																
<b>4HX</b>	<b>4HX</b>	<b>4HX</b>	<b>4HX</b>																																																																
								<table border="1"> <thead> <tr> <th>ID</th> <th>ID</th> <th>ID</th> <th>ID</th> </tr> </thead> <tbody> <tr> <td><b>6HX</b></td> <td><b>6HX</b></td> <td><b>6HX</b></td> <td><b>6HX</b></td> </tr> </tbody> </table>				ID	ID	ID	ID	<b>6HX</b>	<b>6HX</b>	<b>6HX</b>	<b>6HX</b>																																																
ID	ID	ID	ID																																																																
<b>6HX</b>	<b>6HX</b>	<b>6HX</b>	<b>6HX</b>																																																																
<table border="1"> <thead> <tr> <th>Ø d<sub>1</sub> M</th> <th>P mm</th> <th>l<sub>1</sub> mm</th> <th>l<sub>2</sub> mm</th> <th>d<sub>2</sub> mm</th> <th>a mm</th> <th></th> <th></th> <th>ID</th> <th>ID</th> <th>ID</th> <th>ID</th> </tr> </thead> <tbody> <tr> <td>12</td> <td>1.75</td> <td>110</td> <td>24</td> <td>9</td> <td>7</td> <td>4</td> <td>10.2</td> <td>* 152198</td> <td>* 152201</td> <td>* 152204</td> <td>● 148028</td> </tr> <tr> <td>14</td> <td>2</td> <td>110</td> <td>28</td> <td>11</td> <td>9</td> <td>4</td> <td>12</td> <td>* 152199</td> <td></td> <td></td> <td>● 152207</td> </tr> <tr> <td>16</td> <td>2</td> <td>110</td> <td>30</td> <td>12</td> <td>9</td> <td>4</td> <td>14</td> <td></td> <td>* 152203</td> <td></td> <td>● 148029</td> </tr> </tbody> </table>								Ø d <sub>1</sub> M	P mm	l <sub>1</sub> mm	l <sub>2</sub> mm	d <sub>2</sub> mm	a mm			ID	ID	ID	ID	12	1.75	110	24	9	7	4	10.2	* 152198	* 152201	* 152204	● 148028	14	2	110	28	11	9	4	12	* 152199			● 152207	16	2	110	30	12	9	4	14		* 152203		● 148029	<table border="1"> <thead> <tr> <th>ID</th> <th>ID</th> <th>ID</th> <th>ID</th> </tr> </thead> <tbody> <tr> <td><b>6HX</b></td> <td><b>6HX</b></td> <td><b>6HX</b></td> <td><b>6HX</b></td> </tr> </tbody> </table>				ID	ID	ID	ID	<b>6HX</b>	<b>6HX</b>	<b>6HX</b>	<b>6HX</b>
Ø d <sub>1</sub> M	P mm	l <sub>1</sub> mm	l <sub>2</sub> mm	d <sub>2</sub> mm	a mm			ID	ID	ID	ID																																																								
12	1.75	110	24	9	7	4	10.2	* 152198	* 152201	* 152204	● 148028																																																								
14	2	110	28	11	9	4	12	* 152199			● 152207																																																								
16	2	110	30	12	9	4	14		* 152203		● 148029																																																								
ID	ID	ID	ID																																																																
<b>6HX</b>	<b>6HX</b>	<b>6HX</b>	<b>6HX</b>																																																																



										GG350NV-3	GG350TC-3	GG353TC-3	GG550NV-3
<b>GG350NV-3</b>													
<b>GG350TC-3</b>													
<b>GG353TC-3</b>													
<b>GG550NV-3</b>													
$\emptyset d_1$ M	P mm	$l_1$ mm	$l_2$ mm	$l_3$ mm	$d_2$ mm	a mm			ID	ID			
3	0.5	56	12	18	3.5	2.7	3	2.5	● 101172	● 101178			
4	0.7	63	14	21	4.5	3.4	3	3.3	● 101173	● 101179			
5	0.8	70	15	25	6	4.9	3	4.2	● 101174	● 101180			
6	1	80	17	30	6	4.9	3	5	● 101175	● 101181			
8	1.25	90	20	35	8	6.2	4	6.8	● 101076	● 101182			
10	1.5	100	22	39	10	8	4	8.5	● 101171	● 101177			
$\emptyset d_1$ M	P mm	$l_1$ mm	$l_2$ mm	$l_3$ mm	$d_2$ h6 mm	a mm			ID				
5	0.8	70	15	25	6	4.9	3	4.2	● 144947				
6	1	80	17	30	6	4.9	3	5	● 147710				
8	1.25	90	20	35	8	6.2	4	6.8	● 147711				
10	1.5	100	22	39	10	8	4	8.5	● 146708				
$\emptyset d_1$ M	P mm	$l_1$ mm	$l_2$ mm	$l_3$ mm	$d_2$ mm	a mm			ID				
4	0.7	112	14	21	4.5	3.4	3	3.3	● 101196				
5	0.8	125	15	25	6	4.9	3	4.2	● 101197				
6	1	125	17	30	6	4.9	3	5	● 101198				



									GG450NV-3	GG450TC-3	GG453TC-3	GG650NV-3
<b>GG450NV-3</b>   												
<b>GG450TC-3</b>     												
<b>GG453TC-3</b>     												
<b>GG650NV-3</b>   												
									   			
									   			
Ø d <sub>1</sub> M	P mm	l <sub>1</sub> mm	l <sub>2</sub> mm	d <sub>2</sub> mm	a mm			ID	ID	ID	ID	
8	1.25	90	20	6	4.9	4		● 101189	● 101194			
10	1.5	100	22	7	5.5	4		● 101183	● 101195			
12	1.75	110	24	9	7	4		● 101184	● 101190			
14	2	110	28	11	9	4		● 101185	● 101191			
16	2	110	30	12	9	4		● 101186	● 101192			
20	2.5	140	36	16	12	4		● 101187	● 101193			
24	3	160	39	18	14.5	4		● 101188				
Ø d <sub>1</sub> M	P mm	l <sub>1</sub> mm	l <sub>2</sub> mm	d <sub>2</sub> h6 mm	a mm			ID				
12	1.75	110	24	* 10	* 8	4		● 146707				
16	2	110	30	12	9	4		● 162796				
* Norme DC / * DC Norm/ * Norma DC												
Ø d <sub>1</sub> M	P mm	l <sub>1</sub> mm	l <sub>2</sub> mm	d <sub>2</sub> mm	a mm			ID				
8	1.25	140	20	6	4.9	4		● 101203				
10	1.5	160	22	7	5.5	4		● 101199				
12	1.75	180	24	9	7	4		● 101200				
16	2	200	30	12	9	4		● 101201				
20	2.5	224	36	16	12	4		● 101202				

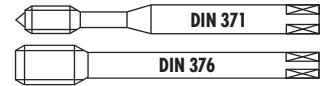

### K

**K313TC-3**

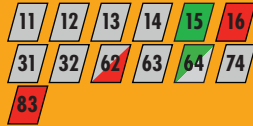
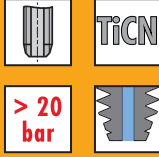

**K413TC-3**

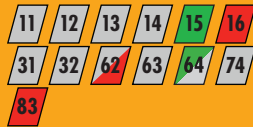
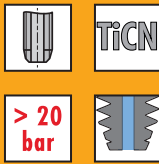

**K313TC-3**

**K413TC-3**

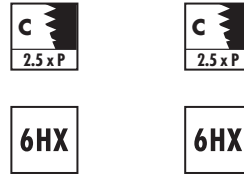
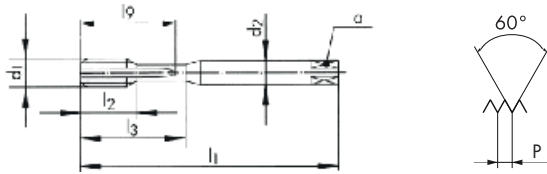

$\emptyset d_1$ M	P mm	$l_1$ mm	$l_2$ mm	$l_3$ mm	$l_0$ mm	$d_2$ mm	a mm		
5	0.8	70	15	25	23	6	4.9	3	4.2
6	1	80	17	30	28	6	4.9	3	5
8	1.25	90	20	35	33	8	6.2	3	6.8
10	1.5	100	22	39	37	10	8	3	8.5
12	1.75	110	24		42	9	7	3	10.2
14	2	110	28		49	11	9	3	12
16	2	110	30		56	12	9	4	14
20	2.5	140	36		70	16	12	5	17.5
24	3	160	39		84	18	14.5	5	21

**ID**

**ID**

- 175961
- 170766
- 170769
- 170772
- 165838
- 170778
- 170783
- 170786
- 170775

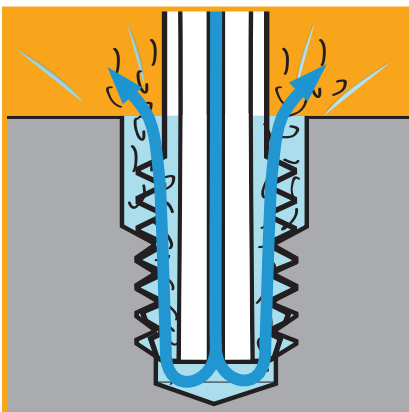



≤ Ø 25.4 > Ø 25.4

PM HSSE

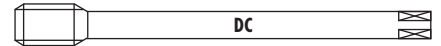

### K

**K613TC-3**

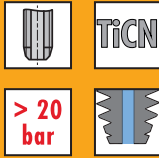

**K613VS-3**

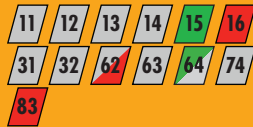
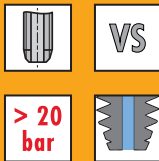

**K613TC-3**

**K613VS-3**

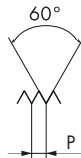
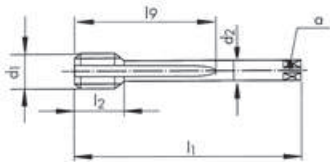

**6HX**

**6HX**

Ø d <sub>1</sub> M	P mm	l <sub>1</sub> mm	l <sub>2</sub> mm	l <sub>3</sub> mm	d <sub>2</sub> mm	a mm			ID	ID
6	1	110	17	30	4.5	3.4	3	5	● 170646	● 172699
8	1.25	110	20	40	6	4.9	3	6.8	● 170649	● 172700
10	1.5	125	22	50	7	5.5	3	8.5	● 170652	● 172701
12	1.75	140	24	60	9	7	3	10.2	● 167982	● 172702
14	2	140	28	70	11	9	4	12	● 167983	
16	2	160	30	80	12	9	4	14	● 167984	● 170573
20	2.5	180	36	100	16	12	5	17.5	● 167985	● 170576
24	3	200	39	120	18	14.5	5	21	● 167986	● 172704
27	3	225	42	135	20	16	5	24	● 167987	
30	3.5	250	45	150	22	18	5	26.5	● 165542	
33	3.5	280	48	165	25	20	5	29.5	● 167988	
36	4	300	51	180	28	22	6	32	● 167989	
39	4	300	55	195	32	24	6	35	● 167990	
42	4.5	355	55	210	32	24	6	37.5	● 167999	

### Vc (m/min) Guide Line

	M5 - M10	M12 - M16	M20 - M30	M33 - M42
	30 - 40	20 - 30	20 - 30	20 - 30
	30 - 40	30 - 40	30 - 40	30 - 40
	20 - 30	15 - 25	15 - 25	15 - 25
	15 - 20	10 - 15	8 - 12	5 - 8
	8 - 12	5 - 8	5 - 8	5 - 8

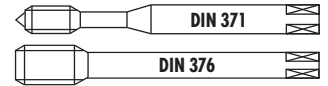

# QTAP

Q320VS-4



Q420VS-4



Q323VS-4

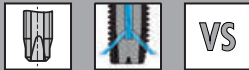

Q423VS-4

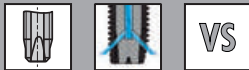

- 11 12 13 14
- 15 21 22 23
- 24 31 32 51
- 52 61 62 63
- 64 71 72 73
- 74 81 82 83
- 91 92 94

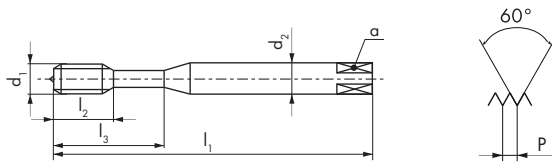

Q320VS-4

Q420VS-4

Q323VS-4

Q423VS-4



NEW



NEW



NEW



NEW



Ø d <sub>1</sub> M	P mm	l <sub>1</sub> mm	l <sub>2</sub> mm	l <sub>3</sub> mm	d <sub>2</sub> mm	a mm		
3	0.5	56	12	18	3.5	2.7	3	2.5
4	0.7	63	14	21	4.5	3.4	3	3.3
5	0.8	70	15	25	6	4.9	3	4.2
6	1	80	17	30	6	4.9	3	5
8	1.25	90	20	35	8	6.2	3	6.8
10	1.5	100	22	39	10	8	3	8.5
12	1.75	110	24		9	7	3	10.2
14	2	110	28		11	9	3	12
16	2	110	30		12	9	3	14
20	2.5	140	36		16	12	4	17.5
24	3	160	39		18	14.5	4	21

ID

ID

ID

ID

● 195494		● 195505	
● 195495		● 195506	
● 195496		● 195507	
● 195497		● 195508	
● 195498		● 195509	
● 195499		● 195510	
	● 195500		● 195511
	● 195501		● 195512
	● 195502		● 195513
	● 195503		● 195514
	● 195504		● 195515





≤ Ø 16 > Ø 16

PM

HSSE

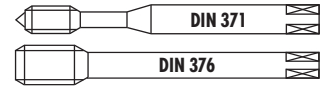

# QTAP

Q360VS-3



Q460VS-3



Q363VS-3



Q463VS-3

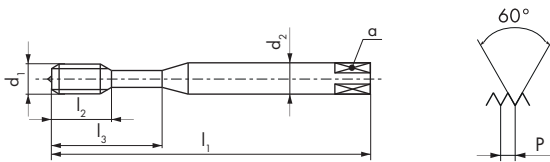
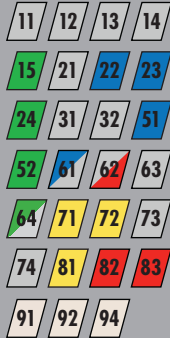

Q360VS-3

Q460VS-3

Q363VS-3

Q463VS-3



NEW



NEW



NEW



NEW



< 2.5 x D



< 2.5 x D



< 2.5 x D



< 2.5 x D



Ø d <sub>1</sub> M	P mm	l <sub>1</sub> mm	l <sub>2</sub> mm	l <sub>3</sub> mm	d <sub>2</sub> mm	a mm		
3	0.5	56	5.5	18	3.5	2.7	3	2.5
4	0.7	63	7.5	21	4.5	3.4	3	3.3
5	0.8	70	9	25	6	4.9	3	4.2
6	1	80	11	30	6	4.9	3	5
8	1.25	90	12.5	35	8	6.2	3	6.8
10	1.5	100	14	39	10	8	3	8.5
12	1.75	110	14		9	7	3	10.2
14	2	110	14		11	9	3	12
16	2	110	18		12	9	3	14
20	2.5	140	24		16	12	3	17.5
24	3	160	27		18	14.5	4	21

ID

ID

ID

ID

● 195516

● 195527

● 195517

● 195528

● 195518

● 195529

● 195519

● 195530

● 195520

● 195531

● 195521

● 195532

● 195522 ● 195533

● 195523 ● 195534

● 195524 ● 195535

● 195525 ● 195536

● 195526 ● 195537



Uniquement pour taraudage synchrone  
Nur für Synchrobearbeitung  
Only for rigid tapping  
Solo per mischilatura sincrona  
Solo para roscado sincronizado  
Только для rigid tapping

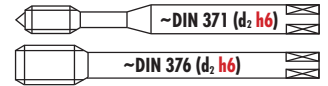

# RTS

## Rigid Tapping Synchro

RTS320VS-4		VS	11 12 13 14 15 21 31 32 51 61 63 64 72 73 74 81 82 83 91 92 94
RTS420VS-4		VS	11 12 13 14 15 21 31 32 51 61 63 64 72 73 74 81 82 83 91 92 94
RTS323VS-4		VS	11 12 13 14 15 21 31 32 51 61 63 64 72 73 74 81 82 83 91 92 94
RTS423VS-4		VS	11 12 13 14 15 21 31 32 51 61 63 64 72 73 74 81 82 83 91 92 94

RTS320VS-4	RTS420VS-4	RTS323VS-4	RTS423VS-4
------------	------------	------------	------------

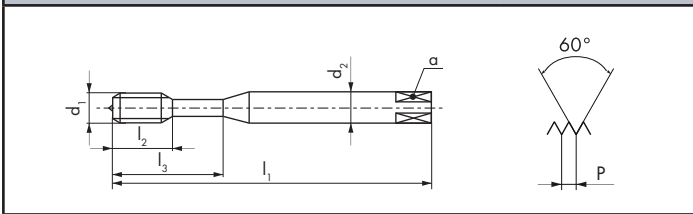
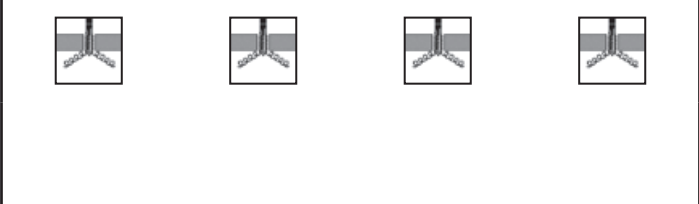
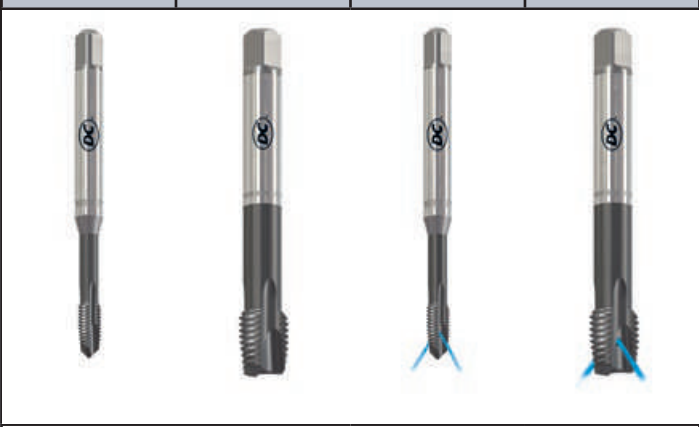

<b>6HX</b>	<b>6HX</b>	<b>6HX</b>	<b>6HX</b>

$\emptyset d_1$ M	P mm	$l_1$ mm	$l_2$ mm	$l_3$ mm	$d_2 h6$ mm	a mm			ID	ID	ID	ID
* 2	0.4	45	8		2.8(h9)	2.1	2	1.6	● 143532			
2.5	0.45	50	10		2.8(h9)	2.1	3	2.05	● 143534			
3	0.5	56	5.5	18	3.5(h9)	2.7	3	2.5	● 150601			
4	0.7	63	7.5	21	4.5(h9)	3.4	3	3.3	● 150603			
5	0.8	70	9	25	6	4.9	3	4.2	● 150605		● 150606	
6	1	80	11	30	6	4.9	3	5	● 150610		● 150611	
8	1.25	90	12.5	35	8	6.2	3	6.8	● 150620		● 150621	
10	1.5	100	14	39	10	8	3	8.5	● 150635		● 150636	
12	1.75	110	14		* 10	* 8	3	10.2		● 151863		● 151864
14	2	110	14		* 12	* 9	3	12		● 162535		
16	2	110	18		12	9	3	14		● 150670		● 150671
20	2.5	140	24		16	12	4	17.5		● 150679		
24	3	160	27		16	12	4	21		● 162787		

\* Norme DC / \* DC Norm / \* Norma DC

\* RTS320VS-3

sur demande  
auf Anfrage  
on request  
su richiesta  
sobre pedido  
no zampocy



Uniquement pour taraudage synchro  
Nur für Synchrobearbeitung  
Only for rigid tapping  
Solo per mescolatura sincrona  
Solo para roscado sincronizado  
Только для rigid tapping

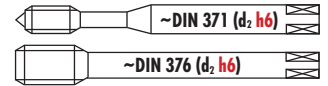

# RTS

## Rigid Tapping Synchro

<b>RTS362VS-3</b>				<table border="1"> <tr><td>11</td><td>12</td><td>13</td><td>14</td></tr> <tr><td>15</td><td>21</td><td>31</td><td>32</td></tr> <tr><td>51</td><td>61</td><td>63</td><td>64</td></tr> <tr><td>72</td><td>73</td><td>74</td><td>81</td></tr> <tr><td>82</td><td>83</td><td>91</td><td>92</td></tr> <tr><td>94</td><td></td><td></td><td></td></tr> </table>	11	12	13	14	15	21	31	32	51	61	63	64	72	73	74	81	82	83	91	92	94			
11	12	13	14																									
15	21	31	32																									
51	61	63	64																									
72	73	74	81																									
82	83	91	92																									
94																												
<b>RTS462VS-3</b>				<table border="1"> <tr><td>11</td><td>12</td><td>13</td><td>14</td></tr> <tr><td>15</td><td>21</td><td>31</td><td>32</td></tr> <tr><td>51</td><td>61</td><td>63</td><td>64</td></tr> <tr><td>72</td><td>73</td><td>74</td><td>81</td></tr> <tr><td>82</td><td>83</td><td>91</td><td>92</td></tr> <tr><td>94</td><td></td><td></td><td></td></tr> </table>	11	12	13	14	15	21	31	32	51	61	63	64	72	73	74	81	82	83	91	92	94			
11	12	13	14																									
15	21	31	32																									
51	61	63	64																									
72	73	74	81																									
82	83	91	92																									
94																												
<b>RTS365VS-3</b>				<table border="1"> <tr><td>11</td><td>12</td><td>13</td><td>14</td></tr> <tr><td>15</td><td>21</td><td>31</td><td>32</td></tr> <tr><td>51</td><td>61</td><td>63</td><td>64</td></tr> <tr><td>72</td><td>73</td><td>74</td><td>81</td></tr> <tr><td>82</td><td>83</td><td>91</td><td>92</td></tr> <tr><td>94</td><td></td><td></td><td></td></tr> </table>	11	12	13	14	15	21	31	32	51	61	63	64	72	73	74	81	82	83	91	92	94			
11	12	13	14																									
15	21	31	32																									
51	61	63	64																									
72	73	74	81																									
82	83	91	92																									
94																												
<b>RTS465VS-3</b>				<table border="1"> <tr><td>11</td><td>12</td><td>13</td><td>14</td></tr> <tr><td>15</td><td>21</td><td>31</td><td>32</td></tr> <tr><td>51</td><td>61</td><td>63</td><td>64</td></tr> <tr><td>72</td><td>73</td><td>74</td><td>81</td></tr> <tr><td>82</td><td>83</td><td>91</td><td>92</td></tr> <tr><td>94</td><td></td><td></td><td></td></tr> </table>	11	12	13	14	15	21	31	32	51	61	63	64	72	73	74	81	82	83	91	92	94			
11	12	13	14																									
15	21	31	32																									
51	61	63	64																									
72	73	74	81																									
82	83	91	92																									
94																												

RTS362VS-3	RTS462VS-3	RTS365VS-3	RTS465VS-3
------------	------------	------------	------------

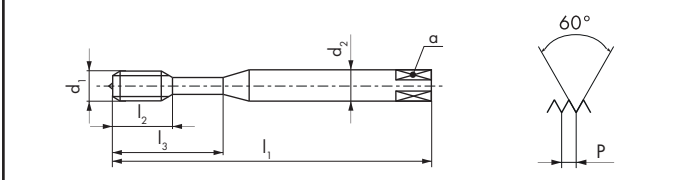
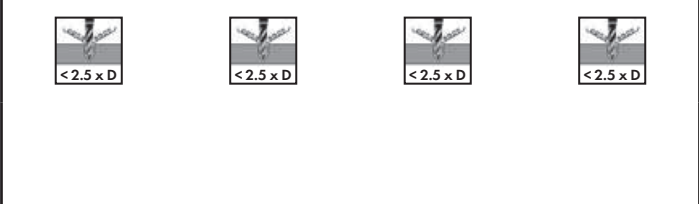
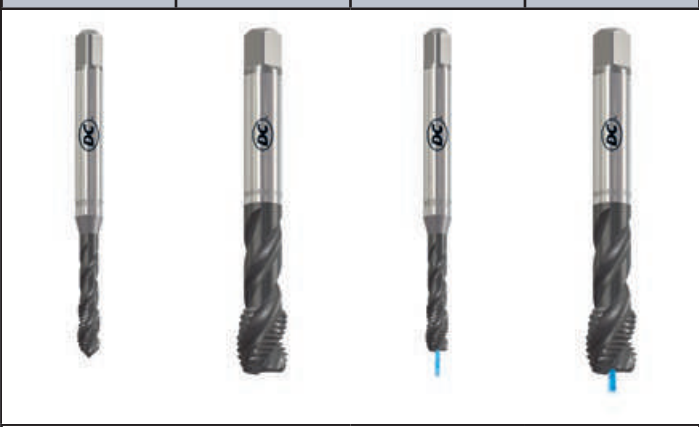

2.5 x P	2.5 x P	2.5 x P	2.5 x P
<b>6HX</b>	<b>6HX</b>	<b>6HX</b>	<b>6HX</b>

Ø d <sub>1</sub> M	P mm	l <sub>1</sub> mm	l <sub>2</sub> mm	l <sub>3</sub> mm	d <sub>2</sub> h6 mm	a mm			ID	ID	ID	ID
* 2	0.4	45	7		2.8(h9)	2.1	3	1.6	● 143536			
* 2.5	0.45	50	9		2.8(h9)	2.1	3	2.05	● 143538			
3	0.5	56	5.5	18	3.5(h9)	2.7	3	2.5	● 150602		● 160477	
4	0.7	63	7.5	21	4.5(h9)	3.4	3	3.3	● 150604		● 160478	
5	0.8	70	9	25	6	4.9	3	4.2	● 150607		● 150608	
6	1	80	11	30	6	4.9	3	5	● 150612		● 150613	
8	1.25	90	12.5	35	8	6.2	3	6.8	● 150622		● 150623	
10	1.5	100	14	39	10	8	3	8.5	● 150637		● 150638	
12	1.75	110	14		* 10	* 8	3	10.2		● 151865		● 151866
14	2	110	14		* 12	* 9	3	12		● 151870		● 150663
16	2	110	18		12	9	3	14		● 150672		● 150673
20	2.5	140	24		16	12	4	17.5		● 150681		● 150682
24	3	160	27		16	12	4	21		● 151873		● 150690

\* Norme DC / \* DC Norm / \* Norma DC

\* RTS360VS-3



sur demande  
auf Anfrage  
on request  
su richiesta  
sobre pedido  
no zampocy



Uniquement pour taraudage synchrone  
Nur für Synchronbearbeitung  
Only for rigid tapping  
Solo per mischilatura sincrona  
Solo para roscado sincronizado  
Только для rigid tapping

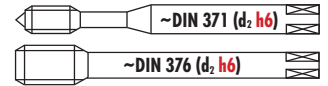

# RTS

## Rigid Tapping Synchro

RTS362VS-3



RTS462VS-3



RTS362VS-3

RTS462VS-3

RTS362VS-3

RTS462VS-3



NEW

NEW



< 2.5 x D

< 2.5 x D

< 2.5 x D

< 2.5 x D

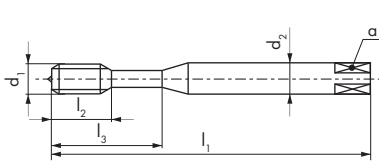

6GX

6GX

7GX

7GX

$\emptyset d_1$ M	P mm	$l_1$ mm	$l_2$ mm	$l_3$ mm	$d_2$ h6 mm	a mm			6G
3	0.5	56	5.5	18	3.5(h9)	2.7	3	2.5	
4	0.7	63	7.5	21	4.5(h9)	3.4	3	3.35	
5	0.8	70	9	25	6	4.9	3	4.25	
6	1	80	11	30	6	4.9	3	5	
8	1.25	90	12.5	35	8	6.2	3	6.8	
10	1.5	100	14	39	10	8	3	8.5	
12	1.75	110	14		* 10	* 8	3	10.3	
16	2	110	18		12	9	3	14	

\* Norme DC / \* DC Norm / \* Norma DC

ID	6H + mm	ID	6H + mm	ID	6H + mm	ID	6H + mm
● 162797	0.020			● 184689	0.036		
● 162798	0.022			● 184691	0.041		
● 162799	0.024			● 184693	0.044		
● 162800	0.026			● 184695	0.050		
● 162801	0.028			● 184697	0.052		
● 162802	0.032			● 184699	0.060		
		● 163253	0.034			● 184701	0.066
		● 172037	0.038			● 184703	0.072



sur demande  
auf Anfrage  
on request  
su richiesta  
sobre pedido  
no zapyty

≥ 0.6 mm



Uniquement pour taraudage synchrone  
 Nur für Synchronbearbeitung  
 Only for rigid tapping  
 Solo per mescolatura sincrona  
 Solo para resacado sincronizado  
 Только для rigid tapping



# RTS

## Rigid Tapping Synchro

**RTS362VS-5**

R40 VS

**RTS365VS-5**

R40 VS

11	12	13	14
15	21	31	32
51	61	63	64
72	73	74	81
82	83	91	92
94			

RTS362VS-5    RTS365VS-5

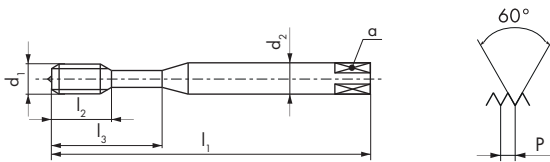

E 1.5 x P

6HX

E 1.5 x P

6HX

$\emptyset d_1$ M	P mm	$l_1$ mm	$l_2$ mm	$l_3$ mm	$d_2 h6$ mm	a mm			ID	ID
3	0.5	56	5.5	18	3.5(h9)	2.7	3	2.5	● 157648	
4	0.7	63	7.5	21	4.5(h9)	3.4	3	3.3	● 157650	
5	0.8	70	9	25	6	4.9	3	4.2	● 157652	● 162791
6	1	80	11	30	6	4.9	3	5	● 158074	● 151803
8	1.25	90	12.5	35	8	6.2	3	6.8	● 158076	● 157821
10	1.5	100	14	39	10	8	3	8.5	● 153286	● 157823

sur demande  
 auf Anfrage  
 on request  
 su richiesta  
 sobre pedido  
 no zapyty

$\geq \emptyset 6 \text{ mm}$



Uniquement pour taraudage synchro  
Nur für Synchrobearbeitung  
Only for rigid tapping  
Solo per mischilatura sincrona  
Solo para roscado sincronizado  
Только для rigid tapping

PM

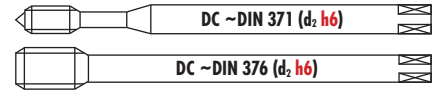

# RTS

## Rigid Tapping Synchro

<b>RTS523VS-4</b>				<table border="1"> <tr><td>11</td><td>12</td><td>13</td><td>14</td></tr> <tr><td>15</td><td>21</td><td>31</td><td>32</td></tr> <tr><td>51</td><td>61</td><td>63</td><td>64</td></tr> <tr><td>72</td><td>73</td><td>74</td><td>81</td></tr> <tr><td>82</td><td>83</td><td>91</td><td>92</td></tr> <tr><td>94</td><td></td><td></td><td></td></tr> </table>	11	12	13	14	15	21	31	32	51	61	63	64	72	73	74	81	82	83	91	92	94			
11	12	13	14																									
15	21	31	32																									
51	61	63	64																									
72	73	74	81																									
82	83	91	92																									
94																												
<b>RTS623VS-4</b>				<table border="1"> <tr><td>11</td><td>12</td><td>13</td><td>14</td></tr> <tr><td>15</td><td>21</td><td>31</td><td>32</td></tr> <tr><td>51</td><td>61</td><td>63</td><td>64</td></tr> <tr><td>72</td><td>73</td><td>74</td><td>81</td></tr> <tr><td>82</td><td>83</td><td>91</td><td>92</td></tr> <tr><td>94</td><td></td><td></td><td></td></tr> </table>	11	12	13	14	15	21	31	32	51	61	63	64	72	73	74	81	82	83	91	92	94			
11	12	13	14																									
15	21	31	32																									
51	61	63	64																									
72	73	74	81																									
82	83	91	92																									
94																												
<b>RTS565VS-3</b>				<table border="1"> <tr><td>11</td><td>12</td><td>13</td><td>14</td></tr> <tr><td>15</td><td>21</td><td>31</td><td>32</td></tr> <tr><td>51</td><td>61</td><td>63</td><td>64</td></tr> <tr><td>72</td><td>73</td><td>74</td><td>81</td></tr> <tr><td>82</td><td>83</td><td>91</td><td>92</td></tr> <tr><td>94</td><td></td><td></td><td></td></tr> </table>	11	12	13	14	15	21	31	32	51	61	63	64	72	73	74	81	82	83	91	92	94			
11	12	13	14																									
15	21	31	32																									
51	61	63	64																									
72	73	74	81																									
82	83	91	92																									
94																												
<b>RTS665VS-3</b>				<table border="1"> <tr><td>11</td><td>12</td><td>13</td><td>14</td></tr> <tr><td>15</td><td>21</td><td>31</td><td>32</td></tr> <tr><td>51</td><td>61</td><td>63</td><td>64</td></tr> <tr><td>72</td><td>73</td><td>74</td><td>81</td></tr> <tr><td>82</td><td>83</td><td>91</td><td>92</td></tr> <tr><td>94</td><td></td><td></td><td></td></tr> </table>	11	12	13	14	15	21	31	32	51	61	63	64	72	73	74	81	82	83	91	92	94			
11	12	13	14																									
15	21	31	32																									
51	61	63	64																									
72	73	74	81																									
82	83	91	92																									
94																												

RTS523VS-4	RTS623VS-4	RTS565VS-3	RTS665VS-3
------------	------------	------------	------------



<b>6HX</b>	<b>6HX</b>	<b>6HX</b>	<b>6HX</b>

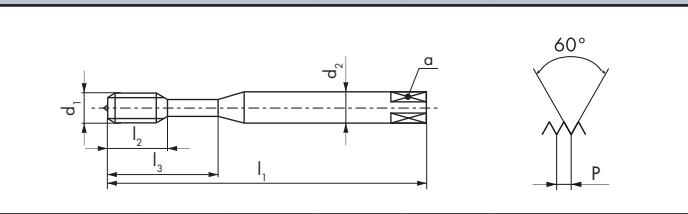

$\emptyset d_1$ M	P mm	$l_1$ mm	$l_2$ mm	$l_3$ mm	$d_2$ h6 mm	a mm		
5	0.8	125	9	25	6	4.9	3	4.2
6	1	125	11	30	6	4.9	3	5
8	1.25	140	12.5	35	8	6.2	3	6.8
10	1.5	160	14	39	10	8	3	8.5
12	1.75	180	14		* 10	* 8	3	10.2
16	2	200	18		12	9	3	14

ID	ID
● 161038	
● 161041	
● 161044	
● 161047	
	● 161050
	● 161053

\* Norme DC / \* DC Norm/ \* Norma DC

$\emptyset d_1$ M	P mm	$l_1$ mm	$l_2$ mm	$l_3$ mm	$d_2$ h6 mm	a mm		
6	1	125	11	30	6	4.9	3	5
8	1.25	140	12.5	35	8	6.2	3	6.8
10	1.5	160	14	39	10	8	3	8.5
12	1.75	180	14		* 10	* 8	3	10.2
16	2	200	18		12	9	3	14

ID	ID
	● 150614
	● 150624
	● 150639
	● 151867
	● 150674

\* Norme DC / \* DC Norm/ \* Norma DC

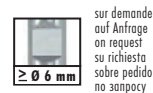



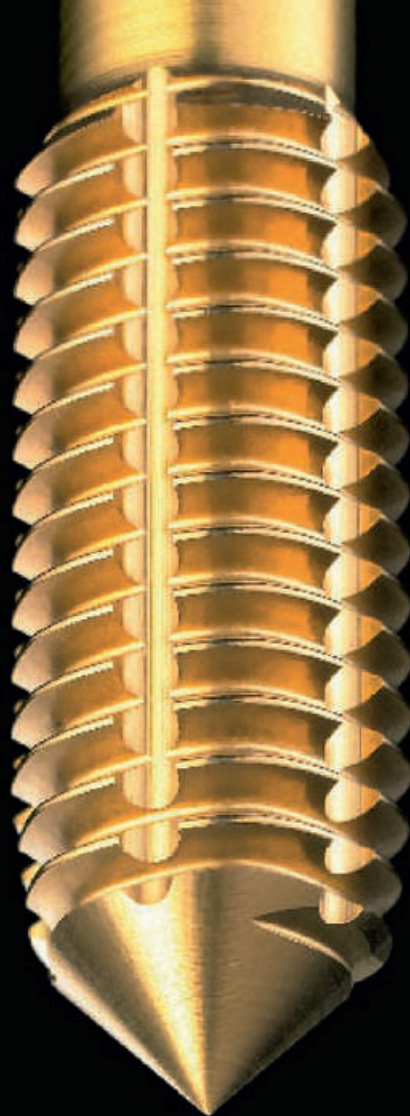

# **GEWINDEFORMEN**

***In diesem Katalog finden Sie das Gewindeformer-  
Programm FS - FPS - FAS in einem separaten Kapitel  
ab Seite 244.***

# **THREAD FORMING**









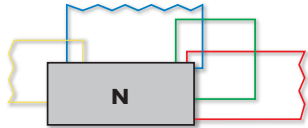

**In this catalogue you will find the FS - FPS - FAS thread  
former programme in a separate chapter starting on  
**page 244.****

										N1110-1	N1110-2	N1110-3	N1110-S						
N1110-1																			
N1110-2																			
N1110-3			<div style="display: flex; gap: 5px;"> <div style="border: 1px solid black; padding: 2px;">31</div> <div style="border: 1px solid black; padding: 2px; background-color: #f00;">62</div> <div style="border: 1px solid black; padding: 2px;">73</div> <div style="border: 1px solid black; padding: 2px;">74</div> <div style="border: 1px solid black; padding: 2px;">91</div> </div>																
N1110-S																			
Ø d <sub>1</sub> M	P mm	l <sub>1</sub> mm	l <sub>2</sub> mm	l <sub>3</sub> mm	d <sub>2</sub> mm	a mm			ID	ID	ID	ID							
1	0.25	40	5.5		2.5	2.1	3	0.75	● 102744	● 102844	● 102917	● 111015							
1.2	0.25	40	5.5		2.5	2.1	3	0.95	● 102746	● 102846	● 102919	● 111017							
1.4	0.3	40	7		2.5	2.1	3	1.1	● 102747	● 102847	● 102920	● 111018							
1.6	0.35	40	8		2.5	2.1	3	1.25	● 102749	● 102849	● 102922	● 111020							
1.7	0.35	40	8		2.5	2.1	3	1.35	● 102750	● 102850	● 102923	● 111021							
1.8	0.35	40	8		2.5	2.1	3	1.45	● 102751	● 102851	● 102924	● 111022							
2	0.4	45	8		2.8	2.1	3	1.6	● 102759	● 102854	● 102934	● 111028							
2.2	0.45	45	9.5		2.8	2.1	3	1.75	● 102761	● 102856	● 102937	● 111030							
2.5	0.45	45	9.5		2.8	2.1	3	2.05	● 102763	● 102858	● 102941	● 111032							
2.6	0.45	45	9.5		2.8	2.1	3	2.15	● 102765	● 102860	● 102944	● 111034							
3	0.5	48	11	18	3.15	2.5	3	2.5	● 102766	● 102861	● 102947	● 111036							
3.5	0.6	50	13	20	3.55	2.8	3	2.9	● 102769	● 102864	● 102950	● 111038							
4	0.7	53	13	21	4	3.15	3	3.3	● 102771	● 102866	● 102956	● 111042							
4.5	0.75	53	13	21	4.5	3.55	3	3.75	* 102775	* 102869	* 102959	* 111044							
5	0.8	58	16	25	5	4	3	4.2	● 102776	● 102870	● 102965	● 111047							
6	1	66	19	30	6.3	5	3	5	● 102781	● 102874	● 102973	● 111053							
7	1	66	19	30	7.1	5.6	3	6	* 102786	* 102876	* 102978	* 111055							
8	1.25	72	22	35	8	6.3	3	6.8	● 102788	● 102878	● 102986	● 111059							
9	1.25	72	22	36	9	7.1	3	7.8	* 102792	* 102880	* 102991	* 111061							
10	1.5	80	24	39	10	8	3	8.5	● 102752	● 102852	● 102931	● 111026							

									N1210-1	N1210-2	N1210-3	N1210-S
N1210-1												
N1210-2												
N1210-3						31 62 73 74 91						
N1210-S												
$\emptyset d_1$ M	P mm	$l_1$ mm	$l_2$ mm	$d_2$ mm	a mm				ID	ID	ID	ID
11	1.5	85	22	8	6.3	3	9.5		* 103302	* 103427	● 103489	* 111168
12	1.75	89	24	9	7.1	3	10.2		● 103303	● 103428	● 103499	● 111173
14	2	95	24	11.2	9	3	12		● 103310	● 103430	● 103510	● 111179
16	2	102	32	12.5	10	3	14		● 103319	● 103432	● 103522	● 111185
18	2.5	112	30	14	11.2	3	15.5		● 103324	● 103434	● 103534	● 111191
20	2.5	112	37	14	11.2	3	17.5		● 103330	● 103436	● 103543	● 111196
22	2.5	115	32	16	12.5	3	19.5		* 103337	* 103438	* 103550	* 125567
24	3	130	45	18	14	4	21		● 103341	● 103440	● 103557	● 111204
27	3	135	45	20	16	4	24		* 103347	* 103442	* 103568	* 111211
30	3.5	138	48	20	16	4	26.5		● 103353	● 103444	● 103579	● 111216
33	3.5	151	51	22.4	18	4	29.5		* 103357	* 103446	* 103581	* 111218
36	4	162	57	25	20	4	32		* 103359	* 103448	* 103583	* 111220





										NP110-1	NP110-2	NP110-3	NP110-S				
<b>NP110-1</b>																	
<b>NP110-2</b>																	
<b>NP110-3</b> <span style="margin-left: 20px;"> </span>										<b>NEW</b>	<b>NEW</b>	<b>NEW</b>	<b>NEW</b>				
<b>NP110-S</b>																	
$\phi d_1$ M	P mm	$l_1$ mm	$l_2$ mm	$l_3$ mm	$d_2$ mm	a mm			ID	ID	ID	ID					
3	0.5	40	11	18	3.5	2.7	3		● 174678	● 174687	● 174696	● 173676					
4	0.7	45	13	21	4.5	3.4	3		● 174679	● 174688	● 174697	● 173644					
5	0.8	50	16	24	6	4.9	3		● 174680	● 174689	● 174698	● 173677					
6	1	56	19	27	6	4.9	3		● 174681	● 174690	● 174699	● 173394					







<b>NP210-1</b>			
<b>NP210-2</b>			
<b>NP210-3</b>			<b>31</b> <b>62</b> <b>73</b> <b>74</b> <b>91</b>
<b>NP210-S</b>			

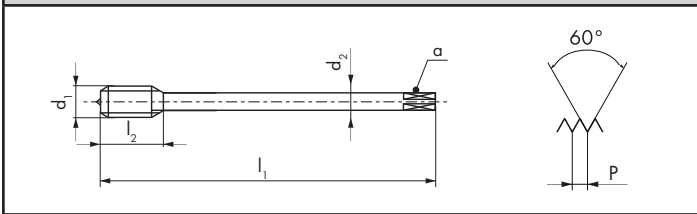

NP210-1	NP210-2	NP210-3	NP210-S
---------	---------	---------	---------



		 < 1.5 x D	 < 2.5 x D
---	---	---	---



 3 x P	 3 x P	 <b>C</b> 3 x P	
		<b>ISO 2 6H</b>	<b>ISO 2 6H</b>

$\varnothing d_1$ M	P mm	$l_1$ mm	$l_2$ mm	$d_2$ mm	a mm			ID	ID	ID	ID
8	1.25	63	22	6	4.9	3	6.8	● 174682	● 174691	● 174700	● 173645
10	1.5	70	24	7	5.5	3	8.5	● 174683	● 174692	● 174701	● 173646
12	1.75	75	28	9	7	3	10.2	● 174684	● 174693	● 174702	● 173647
14	2	80	30	11	9	3	12	● 174685	● 174694	● 174703	● 173648
16	2	80	32	12	9	3	14	● 180705	● 180706	● 180707	● 174677

										N1120-4	N1220-4	N1160-3	N1260-3
N1120-4		62 63 64 72 73 74 81 91											
N1220-4		62 63 64 72 73 74 81 91											
N1160-3		63 72 73 74 81 91											
N1260-3		63 72 73 74 81 91											
Ø d <sub>1</sub> M	P mm	l <sub>1</sub> mm	l <sub>2</sub> mm	l <sub>3</sub> mm	d <sub>2</sub> mm	a mm				ID	ID		
3	0.5	48	11	18	3.15	2.5	3	2.5	•	103068			
4	0.7	53	13	21	4	3.15	3	3.3	•	103075			
5	0.8	58	16	25	5	4	3	4.2	•	103082			
6	1	66	19	30	6.3	5	3	5	•	103090			
8	1.25	72	22	35	8	6.3	3	6.8	•	103102			
10	1.5	80	24	39	10	8	3	8.5	•	103060			
12	1.75	89	24		9	7.1	3	10.2			•	103670	
14	2	95	24		11.2	9	3	12			•	103680	
16	2	102	32		12.5	10	3	14			•	103690	
Ø d <sub>1</sub> M	P mm	l <sub>1</sub> mm	l <sub>2</sub> mm	l <sub>3</sub> mm	d <sub>2</sub> mm	a mm				ID	ID		
3	0.5	48	5.5	18	3.15	2.5	3	2.5				*	103177
4	0.7	53	7.5	21	4	3.15	3	3.3				*	103178
5	0.8	58	9	25	5	4	3	4.2				*	103179
6	1	66	11	30	6.3	5	3	5				*	103180
8	1.25	72	12.5	35	8	6.3	3	6.8				*	103181
10	1.5	80	14	39	10	8	3	8.5				*	103174
12	1.75	89	14		9	7.1	3	10.2					* 103781
16	2	102	18		12.5	10	3	14					* 103782































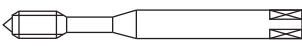
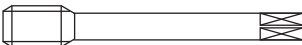

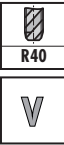

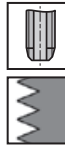
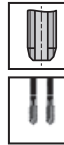
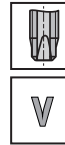

































MF









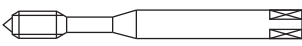
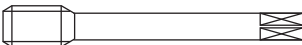



















# K | DEVELOPING THREADING



	N							
<b>Merkmale</b> <b>Characteristics</b>				 V	 TiN	 R15	 R40	
								
<b>Lochart</b> <b>Hole type</b>								
		<b>N320-3</b>				<b>N350-3</b>	<b>N360-3</b>	
<b>DIN lang</b> <b>DIN long</b>	DIN 371	124				124	131	
<b>ISO kurz</b> <b>ISO short</b>	ISO 529							
<b>Toleranz</b> <b>Tolerance</b>	ISO 2 6H	124				124	131	
<b>Übermass</b> <b>Oversize</b>	ISO 3 6G						131	
<b>Feintoleranz</b> <b>Fine tolerance</b>	ISO 1 4H							
<b>LH Linksgewinde</b> <b>LH Left-hand thread</b>	ISO 2 6H							
		<b>N410-3</b>	<b>N420-3</b>	<b>N420-4</b>	<b>N420V-4</b>	<b>N420TN-4</b>	<b>N450-3</b>	<b>N460-3</b>
<b>DIN lang</b> <b>DIN long</b>	DIN 374/~DIN 376	125 - 130		125 - 130	125 - 128	125 - 127	124	132 - 133
<b>ISO kurz</b> <b>ISO short</b>	ISO 529							
<b>Toleranz</b> <b>Tolerance</b>	ISO 2 6H	125 - 129		125 - 129	125 - 128	125 - 127	124	132 - 133
<b>Übermass</b> <b>Oversize</b>	ISO 3 6G							132
<b>Feintoleranz</b> <b>Fine tolerance</b>	ISO 1 4H							
<b>Toleranz</b> <b>Tolerance</b>	7H (EN 60423)		128 - 129					
<b>LH Linksgewinde</b> <b>LH Left-hand thread</b>	ISO 2 6H	130		130				

N					Z			
								
								
								
<b>N360V-3</b>	<b>N360TN-3</b>	<b>N1110-1</b>	<b>N1110-3</b>	<b>N1110-S</b>	<b>Z320V-3</b> <b>Z320V-4</b>	<b>Z320VS-4</b>	<b>Z360V-3</b>	<b>Z370VS-3</b>
131	131				134	134	134	134
		146	146	146				
131	131	146	146	146	134	134	134	134
<b>N460V-3</b>	<b>N460TN-3</b>	<b>N1210-1</b>	<b>N1210-3</b>	<b>N1210-S</b>	<b>Z420V-4</b>	<b>Z420VS-4</b>	<b>Z460V-3</b>	<b>Z470VS-3</b>
132 - 133	132				135	135	135	135
		147 - 148	147 - 148	147 - 148				
132 - 133	132	147 - 148	147 - 148	147 - 148	135	135	135	135

		H		S		SA		
<b>Merkmale</b> <b>Characteristics</b>		 TiCN	 TiCN	 VS	 VS			
		 <b>NEW</b>	 <b>NEW</b>					
<b>Lochart</b> <b>Hole type</b>								
		<b>H320-4</b> <b>H320TC-4</b>	<b>H350-3</b> <b>H350TC-3</b>	<b>S320VS-4</b>	<b>S360VS-3</b>	<b>SA320-4</b>	<b>SA350-3</b>	<b>SA390-3</b>
<b>DIN lang</b> DIN long	DIN 371	136	137	138	138	140	140	139
<b>ISO kurz</b> ISO short	ISO 529							
<b>Toleranz</b> Tolerance	ISO 2 6H	136	137	138	138	140	140	139
<b>Übermass</b> Oversize	ISO 3 6G							
<b>Feintoleranz</b> Fine tolerance	ISO 1 4H					140	140	
<b>LH Linksgewinde</b> LH Left-hand thread	ISO 2 6H							
		<b>H420-4</b> <b>H420TC-4</b>	<b>H450-3</b> <b>H450TC-3</b>	<b>S420VS-4</b>	<b>S460VS-3</b>	<b>SA420-4</b>	<b>SA450-3</b>	
<b>DIN lang</b> DIN long	DIN 374/~DIN 376	136	137	138	138	141	141	
<b>ISO kurz</b> ISO short	ISO 529							
<b>Toleranz</b> Tolerance	ISO 2 6H	136	137	138	138	141	141	
<b>Übermass</b> Oversize	ISO 3 6G							
<b>Feintoleranz</b> Fine tolerance	ISO 1 4H					141	141	
<b>Toleranz</b> Tolerance	7H (EN 60423)							
<b>LH Linksgewinde</b> LH Left-hand thread	ISO 2 6H							

TL		K	QTAP				RTS	
								
VS	 VS	TiCN	VS	VS	VS	VS	VS	VS
								
			NEW	NEW	NEW	NEW		
								
<b>TL320VS-4</b>	<b>TL351VS-3</b>	<b>K313TC-3</b>	<b>Q320VS-4</b>	<b>Q323VS-4</b>	<b>Q360VS-3</b>	<b>Q363VS-3</b>	<b>RTS320VS-4</b>	<b>RTS362VS-3</b>
140	140	142	143	143	144	144	145	145
140	140	142	143	143	144	144	145	145
140	140							
<b>TL420VS-4</b>	<b>TL451VS-3</b>	<b>K413TC-3</b>	<b>Q420VS-4</b>	<b>Q423VS-4</b>	<b>Q460VS-3</b>	<b>Q463VS-3</b>	<b>RTS420VS-4</b>	<b>RTS462VS-3</b>
141	141	142	143	143	144	144	145	145
141	141	142	143	143	144	144	145	145
141	141							

# MF ISO DIN 13

≤ Ø 2.8 > Ø 2.8

PM HSSE

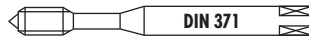

HSSE

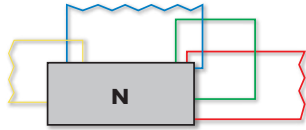
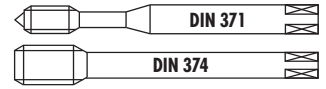

N320-3



62 63 64 72 73 74  
81 91

N350-3



62 63 64 72 73 74  
81 91

N450-3



62 63 64 72 73 74  
81 91

N320-3

N350-3

N450-3

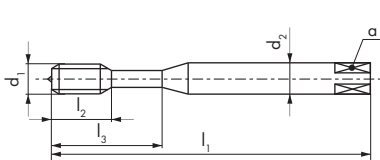

2.5 x P  
ISO 2  
6H

2.5 x P  
ISO 2  
6H

2.5 x P  
ISO 2  
6H

Ø d <sub>1</sub> MF	P mm	l <sub>1</sub> mm	l <sub>2</sub> mm	l <sub>3</sub> mm	d <sub>2</sub> mm	a mm		
2	0.25	45	8		2.8	2.1	2	1.75
2.5	0.35	50	10		2.8	2.1	3	2.15
2.6	0.35	50	10		2.8	2.1	3	2.25
3	0.35	56	12	18	3.5	2.7	3	2.65
3.5	0.35	56	13	20	4	3	3	3.15

ID

- 142689
- 142691
- ★ 142692
- 142693
- 142694

Ø d <sub>1</sub> MF	P mm	l <sub>1</sub> mm	l <sub>2</sub> mm	l <sub>3</sub> mm	d <sub>2</sub> mm	a mm		
4	0.5	63	14	21	4.5	3.4	2	3.5
5	0.5	70	15	25	6	4.9	3	4.5
6	0.75	80	17	30	6	4.9	3	5.25
8	1	90	20		6	4.9	3	7
9	0.75	90	20		7	5.5	3	8.25
10	1	100	22		7	5.5	3	9
18	1.5	110	26		14	11	4	16.5











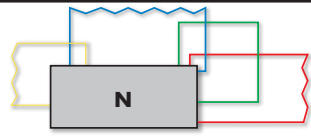









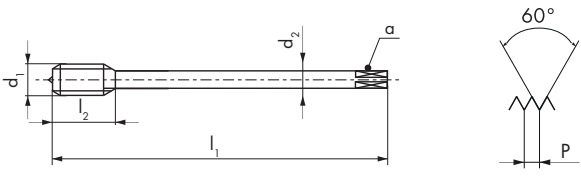

ID

ID











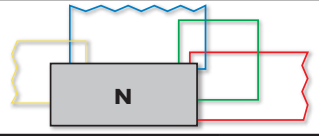

















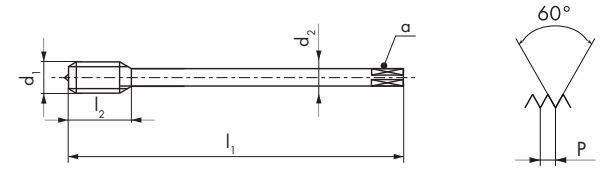

- 101586
- 101588
- 101590
- 102326
- 102328
- 102313
- ★ 102322

P 0.25  
ISO 1  
4H



								N410-3	N420-4	N420V-4	N420TN-4
								<b>N410-3</b>  <span style="margin-left: 20px;">31 62 73 74 91</span>			
<b>N420-4</b>  <span style="margin-left: 20px;">62 63 64 72 73 74 81 91</span>											
<b>N420V-4</b>   <span style="margin-left: 20px;">11 12 31 32</span>											
<b>N420TN-4</b>   <span style="margin-left: 20px;">11 12 13 14 32</span>											
											
											
$\emptyset d_1$ MF	P mm	$l_1$ mm	$l_2$ mm	$d_2$ mm	a mm			ID	ID	ID	ID
* 4	0.35	63	14	2.8	2.1	3	3.65		● 142695		
4	0.5	63	14	2.8	2.1	3	3.5	● 101923	● 102145	● 142715	
4.5	0.5	70	15	3.5	2.7	3	4		● 102150		
5	0.5	70	15	3.5	2.7	3	4.5	● 101941	● 102167	● 142716	
5	0.75	70	15	3.5	2.7	3	4.25		● 102168		
5.5	0.5	80	17	4	3	3	5		● 142696		
6	0.5	80	17	4.5	3.4	3	5.5	● 101951	● 102178	● 142717	
6	0.75	80	17	4.5	3.4	3	5.25	● 101952	● 102179	● 102281	● 102249
7	0.5	80	17	5.5	4.3	3	6.5		● 102187		
7	0.75	80	17	5.5	4.3	3	6.25	● 101954	● 102188		
8	0.5	90	20	6	4.9	3	7.5	● 101955	● 102190	● 142718	
8	0.75	90	20	6	4.9	3	7.25	● 101956	● 102191	● 102283	
8	1	90	20	6	4.9	3	7	● 101957	● 102192	● 102284	● 102250
9	0.5	90	20	7	5.5	3	8.5		● 142697		
9	0.75	90	20	7	5.5	3	8.25		● 102200		
9	1	90	20	7	5.5	3	8		● 102201	● 143935	
10	0.5	100	22	7	5.5	3	9.5		● 142698		
10	0.75	100	22	7	5.5	3	9.25	● 101863	● 102056		
10	1	100	22	7	5.5	3	9	● 101864	● 102057	● 102262	● 102239
10	1.25	100	22	7	5.5	3	8.8	● 101865	● 102058	● 142719	● 148108

\* N420-3 



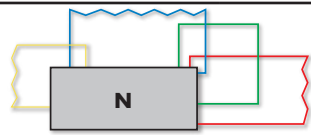

									N410-3	N420-4	N420V-4	N420TN-4
N410-3		31 62 73 74 91										
N420-4		62 63 64 72 73 74 81 91										
N420V-4	 V	11 12 31 32										
N420TN-4	 TiN	11 12 13 14 32										
												
												
Ø d <sub>1</sub> MF	P mm	l <sub>1</sub> mm	l <sub>2</sub> mm	d <sub>2</sub> mm	a mm			ID	ID	ID	ID	
11	0.5	100	19	8	6.2	3	10.5		● 142699			
11	0.75	100	19	8	6.2	3	10.25		● 142700			
11	1	100	19	8	6.2	3	10		● 142701			
11	1.25	100	19	8	6.2	3	9.8		● 142702			
12	0.5	100	14	9	7	3	11.5		● 102066			
12	0.75	100	24	9	7	3	11.25		● 142703			
12	1	100	24	9	7	3	11	● 101867	● 102067	● 142345	● 102241	
12	1.25	100	24	9	7	3	10.8	● 101868	● 102068	● 142721		
12	1.5	100	24	9	7	3	10.5	● 101869	● 102069	● 102264	● 102242	
13	1	100	21	11	9	3	12	● 158401	● 142704			
14	0.5	100	14	11	9	3	13.5		● 142705			
14	0.75	100	24	11	9	3	13.25		● 142706			
14	1	100	24	11	9	3	13	● 101871	● 102077			
14	1.25	100	24	11	9	3	12.8	● 101872	● 102078			
14	1.5	100	24	11	9	3	12.5	● 101873	● 102079	● 102266	● 102244	
15	1	100	26	12	9	3	14	● 101875	● 102085			
15	1.5	100	26	12	9	3	13.5	● 101876	● 102086			
16	0.75	100	26	12	9	3	15.25		● 142708			
16	1	100	26	12	9	*3	15	● 101877	● 102087			
16	1.25	100	26	12	9	*3	14.8	● 101878	● 102088			
16	1.5	100	26	12	9	*3	14.5	● 101879	● 102089	● 102268	● 102246	
17	1	100	26	12	9	3	16		● 142709			
17	1.5	100	26	12	9	3	15.5		● 142710			
18	0.75	110	26	14	11	4	17.25		● 142711			
18	1	110	26	14	11	4	17	● 101881	● 102095			
18	1.5	110	26	14	11	4	16.5	● 101882	● 102096	● 102270	● 145350	
18	2	125	33	14	11	3	16		● 142712			

\* N410-3 =  4

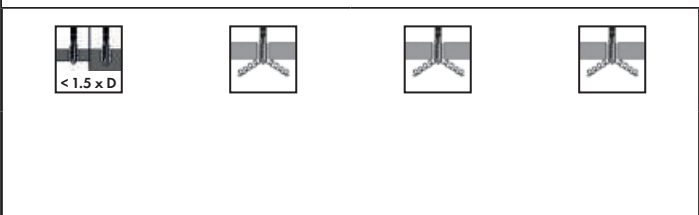





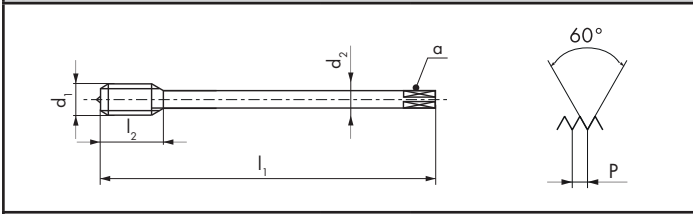

N410-3	N420-4	N420V-4	N420TN-4
--------	--------	---------	----------











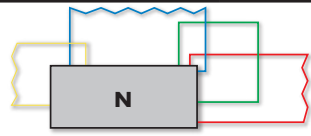































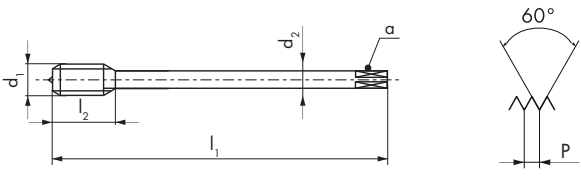











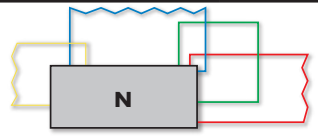





N410-3		31 62 73 74 91
N420-4		62 63 64 72 73 74 81 91
N420V-4	 V	11 12 31 32
N420TN-4	 TiN	11 12 13 14 32

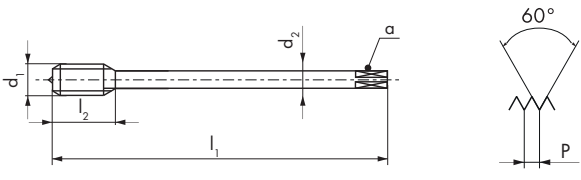

			
ISO 2 6H	ISO 2 6H	ISO 2 6H	ISO 2 6H

Ø d <sub>1</sub> MF	P mm	l <sub>1</sub> mm	l <sub>2</sub> mm	d <sub>2</sub> mm	a mm			ID	ID	ID	ID
20	1	125	28	16	12	4	19		● 102098		
20	1.5	125	28	16	12	4	18.5	● 101884	● 102099	● 102272	● 143932
20	2	140	36	16	12	3	18	● 105130	● 102100		
22	1	125	28	18	14.5	4	21		● 102104		
22	1.5	125	28	18	14.5	4	20.5	● 101886	● 102105	● 102274	
22	2	140	36	18	14.5	3	20	● 101887	● 142714		
24	1	140	30	18	14.5	4	23		● 102107		
24	1.5	140	30	18	14.5	4	22.5	● 101889	● 102108	● 102276	
24	2	140	34	18	14.5	4	22	● 101890	● 102109	● 102277	
25	1	140	30	18	14.5	4	24		● 142722		
25	1.5	140	30	18	14.5	4	23.5	● 101892	● 102112		
25	2	140	34	18	14.5	4	23		● 142723		
26	1	140	30	18	14.5	4	25		● 102113		
26	1.5	140	30	18	14.5	4	24.5	● 101893	● 102114	● 145896	
27	1.5	140	34	20	16	4	25.5		● 102115		
27	2	140	34	20	16	4	25	● 101894	● 102116		
28	1	140	30	20	16	4	27		● 142725		
28	1.5	140	30	20	16	4	26.5	● 101896	● 102118		
28	2	140	30	20	16	4	26	● 122023			

								N410-3	N420-4	N420V-4	N420-3
								N410-3		31 62 73 74 91	   
N420-4		62 63 64 72 73 74 81 91	   		   						
N420V-4	 V	11 12 31 32	   		   						
N420-3		62 63 64 72 73 74 81 91	   		   						
								 2.5 x P 	 4 x P 	 4 x P 	 2.5 x P 
Ø d <sub>1</sub> MF	P mm	l <sub>1</sub> mm	l <sub>2</sub> mm	d <sub>2</sub> mm	a mm		 6H	ID	ID	ID	ID
30	1	150	32	22	18	4	29	● 101898	● 102121		
30	1.5	150	32	22	18	4	28.5	● 101899	● 102122	● 143978	
30	2	150	32	22	18	4	28	● 101900	● 102123	● 143766	
32	1	150	32	22	18	4	31	● 101902			
32	1.5	150	32	22	18	4	30.5	● 101903	● 102126		● 143812
32	2	150	32	22	18	4	30	● 101904	● 102127		
33	1.5	160	32	25	20	4	31.5	● 101905	● 102128		
33	2	160	32	25	20	4	31	● 101906	● 102129		
34	1.5	170	32	28	22	4	32.5	● 101909			
35	1.5	170	32	28	22	4	33.5	● 101910	● 102132		
35	2	170	32	28	22	4	33	● 101911			
36	1.5	170	34	28	22	4	34.5	● 101912	● 102134		
36	2	170	34	28	22	4	34	● 101913	● 102135		
36	3	200	45	28	22	4	33	● 101914	● 102136		
38	1.5	170	34	28	22	4	36.5	● 101917	● 102139		
38	2	170	34	28	22	4	36	● 101918			
39	2	170	34	32	24	4	37	● 101920			
39	3	200	45	32	24	4	36	● 101921			

								N410-3	N420-4	N420-3
								N410-3		31 62 73 74 91
N420-4		62 63 64 72 73 74 81 91								
N420-3		62 63 64 72 73 74 81 91								
								 C 2.5 x P ISO 2 6H	 B 4 x P ISO 2 6H	 2.5 x P ISO 3 7H
Ø d <sub>1</sub> MF	P mm	l <sub>1</sub> mm	l <sub>2</sub> mm	d <sub>2</sub> mm	a mm			ID	ID	ID
40	1	170	34	32	24	5	39	● 101925		
40	1.5	170	34	32	24	5	38.5	● 101926	● 102152	● 143813
40	2	170	34	32	24	5	38	● 101927	● 102153	
40	3	200	45	32	24	4	37	★ 101928		
42	1.5	170	34	32	24	5	40.5	● 101929	● 102155	
42	2	170	34	32	24	5	40	● 101930	● 102156	
42	3	200	45	32	24	4	39	● 101931	● 102157	
45	1.5	180	34	36	29	5	43.5	● 101933	● 102159	
45	2	180	34	36	29	5	43	● 101934		
45	3	200	45	36	29	4	42	● 101935		
48	1.5	190	36	36	29	5	46.5	● 101937	● 102163	
48	2	190	36	36	29	5	46	● 101938	● 102164	
48	3	220	48	36	29	5	45	● 101939	● 102165	
50	1.5	190	36	36	29	5	48.5	● 101943	● 102176	● 143814
50	2	190	36	36	29	5	48	● 101944	★ 102177	
52	2	190	36	40	32	5	50	● 101947		
60	2	220	42	45	35	5	58	● 105132		
63	1.5	220	38	45	35	5	61.5			● 143815

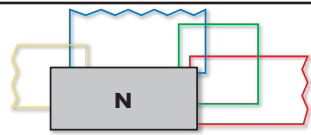

N410-3 LH



LH

31 62 73 74 91

N420-4 LH



LH

62 63 64 72 73 74  
81 91

N410-3 LH



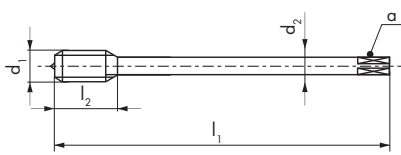







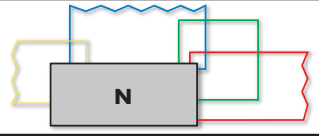

N420-4 LH

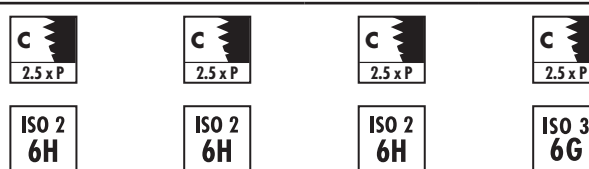
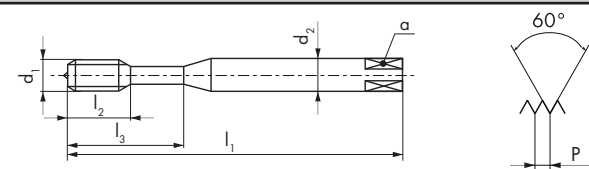

$\emptyset d_1$ MF	P mm	$l_1$ mm	$l_2$ mm	$d_2$ mm	a mm			ID	ID
4	0.5	63	14	2.8	2.1	3	3.5	● 104844	
5	0.5	70	15	3.5	2.7	3	4.5	● 104845	
6	0.5	80	17	4.5	3.4	3	5.5	● 104846	● 104870
6	0.75	80	17	4.5	3.4	3	5.25	● 104847	● 105133
7	0.75	80	17	5.5	4.3	3	6.25	● 104848	
8	0.5	90	20	6	4.9	3	7.5	● 104849	
8	0.75	90	20	6	4.9	3	7.25	● 104850	● 104871
8	1	90	20	6	4.9	3	7	● 104851	● 104872
10	0.75	100	22	7	5.5	3	9.25	● 104852	
10	1	100	22	7	5.5	3	9	● 104853	● 104873
10	1.25	100	22	7	5.5	3	8.8		● 104874
12	1	100	24	9	7	3	11	● 104854	● 104875
12	1.25	100	24	9	7	3	10.8	● 104855	● 104876
12	1.5	100	24	9	7	3	10.5	● 104856	● 104877
14	1	100	24	11	9	3	13	● 104857	● 104878
14	1.25	100	24	11	9	3	12.8	● 104858	
14	1.5	100	24	11	9	3	12.5	● 104859	● 104879
16	1	100	26	12	9	*3	15	● 104860	● 104880
16	1.5	100	26	12	9	*3	14.5	● 104861	● 104881
18	1	110	26	14	11	4	17	● 104862	
18	1.5	110	26	14	11	4	16.5	● 104863	● 104882
20	1	125	28	16	12	4	19	● 104864	
20	1.5	125	28	16	12	4	18.5	● 104865	● 104883
22	1.5	125	28	18	14.5	4	20.5	● 104866	● 104884
24	1.5	140	30	18	14.5	4	22.5	● 104867	● 104885
24	2	140	34	18	14.5	4	22	● 104868	● 104886
28	1.5	140	30	20	16	4	26.5	● 105166	
30	1.5	150	32	22	18	4	28.5	● 105167	● 105165
30	2	150	32	22	18	4	28	● 105168	

\* N410-3 LH = 4



										N360-3	N360V-3	N360TN-3	N360-3
<b>N360-3</b>  <span style="margin-left: 200px;">63 72 73 74 81 91</span>													
<b>N360V-3</b>   <span style="margin-left: 150px;">11 12 32</span>													
<b>N360TN-3</b>   <span style="margin-left: 150px;">11 12 13 14 32</span>													
													
													
$\varnothing d_1$ MF	P mm	$l_1$ mm	$l_2$ mm	$l_3$ mm	$d_2$ mm	a mm			ID	ID	ID	ID <sup>6H</sup> + mm	
4	0.5	63	7.5	21	4.5	3.4	3	3.5	• 101632	• 101712	• 111618	• 101631 0.020	
5	0.5	70	9	25	6	4.9	3	4.5	• 101641	• 101714	• 111617	• 101640 0.020	
6	0.5	80	11	30	6	4.9	3	5.5	• 101648	• 143990			
6	0.75	80	11	30	6	4.9	3	5.25	• 101650	• 101716	• 101702	• 101649 0.022	
8	0.75	90	12.5	35	8	6.2	3	7.25	• 101658	• 101719		• 101657 0.022	
8	1	90	12.5	35	8	6.2	3	7	• 101660	• 101720	• 101704	• 101659 0.026	
10	0.75	100	14	39	10	8	3	9.25	• 101606	• 144401			
10	1	100	14	39	10	8	3	9	• 101608	• 101706	• 101695	• 101607 0.026	
10	1.25	100	14	39	10	8	3	8.8	• 101609	• 105134	• 110965		

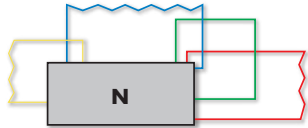

N460-3



63 72 73 74 81 91

N460V-3



11 12 32

N460TN-3



11 12 13 14 32



N460-3

N460V-3

N460TN-3

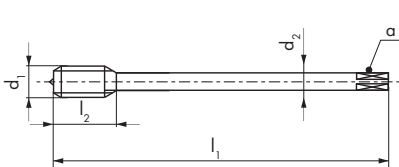
N460-3



Ø d <sub>1</sub> MF	P mm	l <sub>1</sub> mm	l <sub>2</sub> mm	d <sub>2</sub> mm	a mm			ID	ID	ID	ID <sup>6H</sup> + mm
12	1	100	14	9	7	3	11	● 102353	● 102462	● 102447	● 102352 0.026
12	1.25	100	14	9	7	3	10.8	● 102354	● 102463	● 144202	
12	1.5	100	14	9	7	3	10.5	● 102356	● 102464	● 102448	● 102355 0.032
13	1	100	14	11	9	3	12	● 102364			
14	1	100	14	11	9	3	13	● 102365	● 102466		
14	1.5	100	14	11	9	3	12.5	● 102367	● 102467	● 102450	● 102366 0.032
15	1	100	14	12	9	3	14	● 102370			
15	1.5	100	18	12	9	3	13.5	● 102371			
16	1	100	14	12	9	4	15	● 102372	● 102469		
16	1.5	100	14	12	9	4	14.5	● 102374	● 102470	● 102452	● 102373 0.032
18	1	110	18	14	11	4	17	● 102380	● 143926		
18	1.5	110	18	14	11	4	16.5	● 102382	● 102472	● 145346	● 102381 0.032
20	1	125	20	16	12	4	19	● 102384	● 146377		
20	1.5	125	20	16	12	4	18.5	● 102386	● 102474	● 148780	
20	2	140	24	16	12	4	18	● 102387	● 143566		
22	1	125	20	18	14.5	4	21	● 102392	● 147702		
22	1.5	125	20	18	14.5	4	20.5	● 102393	● 102476		
24	1.5	140	22	18	14.5	4	22.5	● 102396	● 102478		
24	2	140	22	18	14.5	4	22	● 102397	● 102479		
25	1.5	140	22	18	14.5	4	23.5	● 102399	● 143810		
26	1.5	140	22	18	14.5	4	24.5	● 102400	● 143952		
27	1.5	140	22	20	16	4	25.5	● 102401	● 143965		
27	2	140	22	20	16	4	25	● 102402	● 144201		
28	1.5	140	22	20	16	4	26.5	● 102403	● 144997		

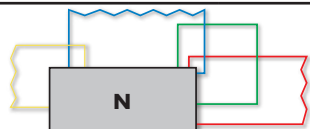

N460-3



63 72 73 74 81 91

N460V-3



11 12 32

N460-3

N460V-3

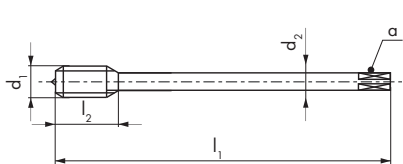

$\emptyset d_1$ MF	P mm	$l_1$ mm	$l_2$ mm	$d_2$ mm	a mm			ID	ID
30	1.5	150	24	22	18	4	28.5	● 102404	● 142524
30	2	150	24	22	18	4	28	● 102405	● 142581
32	1.5	150	24	22	18	4	30.5	● 102406	● 143605
33	2	160	26	25	20	4	31	● 102407	● 147604
33	3	180	33	25	20	4	30	● 175437	● 150448
35	1.5	170	24	28	22	5	33.5	● 102408	● 146846
36	1.5	170	24	28	22	5	34.5	● 102409	● 143824
36	2	170	28	28	22	5	34	● 175436	● 164870
36	3	200	36	28	22	4	33	● 115072	● 150453
39	3	200	40	32	24	5	36	● 174995	● 122669
42	3	200	40	32	24	5	39	● 174996	● 150436

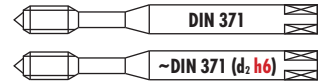

										Z320V-4	Z320VS-4	Z360V-3	Z370VS-3	
Z320V-4		V	11 12 13 21 32											
Z320VS-4		VS	11 12 13 14 21 22 23 32 61 63 94											
Z360V-3		V	12 21 32											
Z370VS-3		VS		14 15 21 22 23 24 51 61 94										
Z370VS-3		VS		13 14 15 21 22 23 24 51 52										<b>PM</b>
$\emptyset d_1$ MF	P mm	$l_1$ mm	$l_2$ mm	$l_3$ mm	$d_2$ mm	a mm				ID	ID			
* 3	0.35	56	12	18	3.5	2.7	3	2.65		● 115468				
6	0.75	80	17	30	6	4.9	3	5.25		● 142726	● 123691			
8	1	90	20	35	8	6.2	3	7		● 142727	● 124289			
10	1	100	22	39	10	8	3	9		● 142728	● 120060			
10	1.25	100	22	39	10	8	3	8.8		● 196023	● 196024			
$\emptyset d_1$ MF	P mm	$l_1$ mm	$l_2$ mm	$l_3$ mm	$d_2$ mm	a mm				ID	ID			
4	0.5	63	7.5	21	4.5	3.4	3	3.5			● 104675			
5	0.5	70	9	25	6	4.9	3	4.5			● 104676			
6	0.75	80	11	30	6	4.9	3	5.25			● 104677			
8	1	90	12.5	35	8	6.2	3	7			● 104678			
10	1	100	14	39	10	8	3	9			● 104674			
$\emptyset d_1$ MF	P mm	$l_1$ mm	$l_2$ mm	$l_3$ mm	$d_2$ h6 mm	a mm				ID	ID			
6	0.75	80	11	30	6	4.9	3	5.25			● 166117			
8	1	90	12.5	35	8	6.2	3	7			● 166118			
10	1	100	14	39	10	8	3	9			● 166119			
10	1.25	100	14	39	10	8	3	8.8			● 196020			
* Z320V-3														

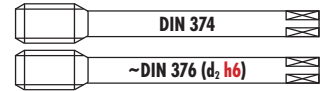

									Z420V-4	Z420VS-4	Z460V-3	Z470VS-3
<b>Z420V-4</b>		V	11 12 13 21 32									
<b>Z420VS-4</b>		VS	11 12 13 14 21 22 23 32 61 63 94									
<b>Z460V-3</b>		V	12 21 32									
<b>Z470VS-3</b>		VS		14 15 21 22 23 24 51 61 94								
<b>Z470VS-3</b>		VS		13 14 15 21 22 23 24 51 52								<b>PM</b>
									<b>ISO 2 6H</b>	<b>ISO 2 6H</b>	<b>ISO 2 6H</b>	<b>6HX</b>
$\emptyset d_1$ MF	P mm	$l_1$ mm	$l_2$ mm	$d_2$ mm	a mm			ID	ID	ID	ID	
12	1	100	24	9	7	3	11	● 142729				
12	1.5	100	24	9	7	3	10.5	● 142730	● 120421			
14	1.5	100	24	11	9	3	12.5	● 142731	● 120688			
16	1.5	100	26	12	9	3	14.5	● 142732	● 120878			
18	1.5	110	26	14	11	4	16.5	● 196025	● 196027			
20	1.5	125	28	16	12	4	18.5	● 163931	● 196026			
12	1	100	14	9	7	3	11		● 104729			
12	1.5	100	14	9	7	3	10.5		● 104730			
14	1.5	100	14	11	9	3	12.5		● 104731			
16	1.5	100	14	12	9	4	14.5		● 104732			
18	1.5	110	18	14	11	4	16.5		● 104733			
20	1.5	125	20	16	12	4	18.5		● 104734			
22	1.5	125	20	18	14.5	4	20.5		● 104735			
24	1.5	140	22	18	14.5	4	22.5		● 104736			
24	2	140	22	18	14.5	4	22		● 104737			
$\emptyset d_1$ MF	P mm	$l_1$ mm	$l_2$ mm	$d_2$ h6 mm	a mm			ID	ID	ID	ID	
12	1.5	110	14	* 10	* 8	4	10.5		● 166120			
14	1.5	110	14	* 12	* 9	4	12.5		● 166121			
16	1.5	110	18	12	9	4	14.5		● 166122			
18	1.5	125	21	14	11	4	16.5		● 196021			
20	1.5	140	24	16	12	4	18.5		● 196022			
* Norme DC / * DC Norm/ * Norma DC												

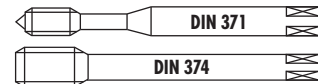

										H320-4	H420-4	H320TC-4	H420TC-4
<b>H320-4</b> <span style="background-color: #008000; color: white; padding: 2px;">15</span> <span style="background-color: #FF0000; color: white; padding: 2px;">16</span> <span style="background-color: #FF0000; color: white; padding: 2px;">62</span> <span style="background-color: #008000; color: white; padding: 2px;">64</span> <span style="background-color: #FF0000; color: white; padding: 2px;">82</span>													
<b>H420-4</b> <span style="background-color: #008000; color: white; padding: 2px;">15</span> <span style="background-color: #FF0000; color: white; padding: 2px;">16</span> <span style="background-color: #FF0000; color: white; padding: 2px;">62</span> <span style="background-color: #008000; color: white; padding: 2px;">64</span> <span style="background-color: #FF0000; color: white; padding: 2px;">82</span>													
<b>H320TC-4</b> <span style="background-color: #008000; color: white; padding: 2px;">15</span> <span style="background-color: #FF0000; color: white; padding: 2px;">16</span> <span style="background-color: #008000; color: white; padding: 2px;">24</span> <span style="background-color: #008000; color: white; padding: 2px;">31</span> <span style="background-color: #FF0000; color: white; padding: 2px;">82</span> <span style="background-color: #FF0000; color: white; padding: 2px;">83</span> <span style="background-color: #008000; color: white; padding: 2px;">92</span> <span style="background-color: #008000; color: white; padding: 2px;">93</span>												<b>NEW</b>	<b>NEW</b>
<b>H420TC-4</b> <span style="background-color: #008000; color: white; padding: 2px;">15</span> <span style="background-color: #FF0000; color: white; padding: 2px;">16</span> <span style="background-color: #008000; color: white; padding: 2px;">24</span> <span style="background-color: #008000; color: white; padding: 2px;">31</span> <span style="background-color: #FF0000; color: white; padding: 2px;">82</span> <span style="background-color: #FF0000; color: white; padding: 2px;">83</span> <span style="background-color: #008000; color: white; padding: 2px;">92</span> <span style="background-color: #008000; color: white; padding: 2px;">93</span>													
$\emptyset d_1$ MF	P mm	$l_1$ mm	$l_2$ mm	$l_3$ mm	$d_2$ mm	a mm				ID	ID	ID	ID
6	0.75	80	17	30	6	4.9	3		5.25	● 101214		● 196035	
8	0.75	90	20	35	8	6.2	3		7.25	● 101216			
8	1	90	20	35	8	6.2	3		7	● 101217		● 196036	
10	1	100	22	39	10	8	3		9	● 101204		● 172963	
10	1.25	100	22	39	10	8	3		8.8	● 175213		● 173079	
12	1.25	100	24		9	7	4		10.8		● 101273		
12	1.5	100	24		9	7	4		10.5		● 101274		● 196037
14	1.5	100	24		11	9	4		12.5		● 101276		● 164053
16	1.5	100	26		12	9	4		14.5		● 101278		● 196038
18	1.5	110	26		14	11	4		16.5		● 101280		● 196039
20	1.5	125	28		16	12	4		18.5		● 101282		● 148362
24	2	140	34		18	14.5	4		22		● 101285		



# MF ISO DIN 13

≤ Ø 25.4 > Ø 25.4

PM HSSE

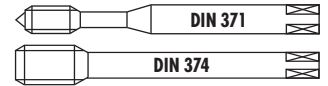

										H350-3	H450-3	H350TC-3	H450TC-3
												<b>NEW</b>	<b>NEW</b>
Ø d <sub>1</sub> MF	P mm	l <sub>1</sub> mm	l <sub>2</sub> mm	l <sub>3</sub> mm	d <sub>2</sub> mm	a mm				ID	ID	ID	ID
6	0.75	80	11	30	6	4.9	3	5.25		● 101249		● 196033	
8	0.75	90	12.5	35	8	6.2	3	7.25		● 101252			
8	1	90	12.5	35	8	6.2	3	7		● 101253		● 150356	
10	1	100	14	39	10	8	3	9		● 101235		● 148753	
10	1.25	100	14	39	10	8	3	8.8		● 145590		● 196034	
12	1	100	14		9	7	4	11			● 101302		
12	1.5	100	14		9	7	4	10.5			● 101303		● 145561
14	1.5	100	14		11	9	4	12.5			● 101306		● 184003
16	1.5	100	14		12	9	4	14.5			● 101308		● 176013
18	1.5	110	18		14	11	4	16.5			● 101310		● 160146
20	1.5	125	20		16	12	4	18.5			● 101312		● 160147
22	1.5	125	20		18	14.5	4	20.5			● 101314		
24	1.5	140	22		18	14.5	4	22.5			● 101316		
24	2	140	22		18	14.5	4	22			● 101317		
27	2	140	22		20	16	4	25			● 101319		
30	1.5	150	24		22	18	4	28.5			● 101321		
30	2	150	24		22	18	4	28			● 101322		

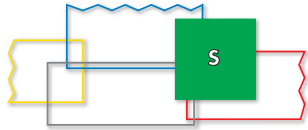

<b>S320VS-4</b>		<b>VS</b>	13 15 16 22 23 24 52
<b>S420VS-4</b>		<b>VS</b>	13 15 16 22 23 24 52
<b>S360VS-3</b>		<b>VS</b>	13 15 16 22 23 24 52
<b>S460VS-3</b>		<b>VS</b>	13 15 16 22 23 24 52

S320VS-4	S420VS-4	S360VS-3	S460VS-3

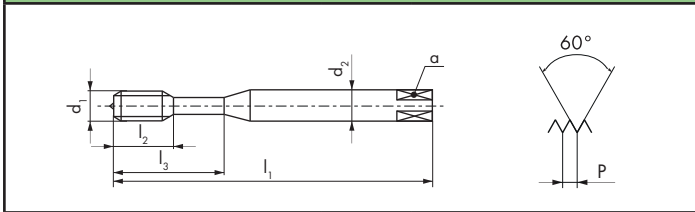

<b>6HX</b>	<b>6HX</b>	<b>6HX</b>	<b>6HX</b>

Ø d <sub>1</sub> MF	P mm	l <sub>1</sub> mm	l <sub>2</sub> mm	l <sub>3</sub> mm	d <sub>2</sub> mm	a mm		
6	0.75	80	17	30	6	4.9	3	5.25
8	1	90	20	35	8	6.2	3	7
10	1	100	22	39	10	8	3	9
12	1.5	100	24		9	7	4	10.5
14	1.5	100	24		11	9	4	12.5
16	1.5	100	26		12	9	4	14.5

ID	ID
★ 123690	
● 124288	
● 120059	
	● 120420
	● 120687
	● 120877

Ø d <sub>1</sub> MF	P mm	l <sub>1</sub> mm	l <sub>2</sub> mm	l <sub>3</sub> mm	d <sub>2</sub> mm	a mm		
8	1	90	12.5	35	8	6.2	3	7
10	1	100	14	39	10	8	3	9
12	1.5	100	14		9	7	4	10.5
14	1.5	100	14		11	9	4	12.5
16	1.5	100	14		12	9	4	14.5

ID	ID
	● 111528
	● 111529
	● 111540
	● 111541
	● 111542

# aero

SA390-3



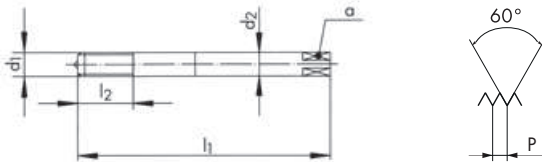

16 53

SA390-3



6HX

Ø d <sub>1</sub> MF	P mm	l <sub>1</sub> mm	l <sub>2</sub> mm	d <sub>2</sub> mm	a mm			ID
10	1	100	30	10	8	3	9	* 149751
12	1	110	35	12	9	4	11	* 149769
12	1.5	110	35	12	9	4	10.5	* 149773
14	1.5	110	40	16	12	4	12.5	* 149790

## aero

**SA320-4** **15 16 52 64**

**SA350-3** **R15 15 16 52 64**

**TL320VS-4** **VS 41 42**

**TL351VS-3** **R15 VS 41 42**

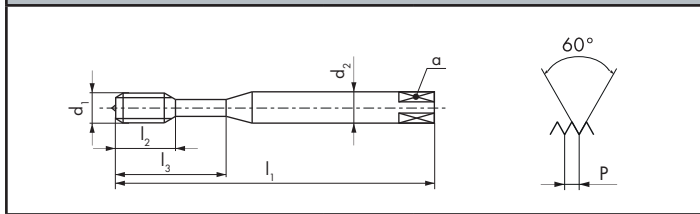

Ø d <sub>1</sub> MF	P mm	l <sub>1</sub> mm	l <sub>2</sub> mm	l <sub>3</sub> mm	d <sub>2</sub> mm	a mm		
4	0.5	63	14		4.5	3.4	3	3.5
5	0.5	70	15		6	4.9	3	4.5
6	0.5	80	15	23	6	4.9	3	5.5
8	1	90	18	29	8	6.2	3	7
10	1	100	20	33	10	8	3	9

Ø d <sub>1</sub> MF	P mm	l <sub>1</sub> mm	l <sub>2</sub> mm	l <sub>3</sub> mm	d <sub>2</sub> mm	a mm		
4	0.5	63	14		4.5	3.4	3	3.5
5	0.5	70	15		6	4.9	3	4.5
6	0.5	80	15	23	6	4.9	3	5.5
8	1	90	18	29	8	6.2	3	7
10	1	100	20	33	10	8	3	9

SA320-4	SA350-3	TL320VS-4	TL351VS-3
---------	---------	-----------	-----------

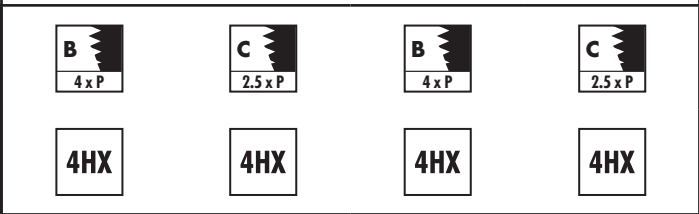
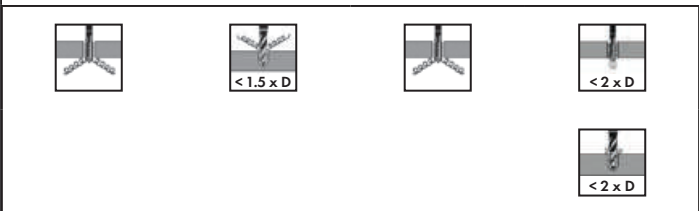

ID	ID	ID	ID
	* 149079		● 152033
	● 149144		● 152049
* 149193		* 152058	● 152059
● 149304	● 149306		● 152080
● 149362	● 149364		● 152093

ID	ID	ID	ID
<b>6HX</b>	<b>6HX</b>	<b>6HX</b>	<b>6HX</b>
● 149081	● 149083		● 152035
● 149146	● 149148		● 152051
	* 149199		● 152061
● 149308	● 149310		● 148019
● 149366	● 149368	* 152094	● 148026



## aero

SA420-4



15 16 52 64

SA450-3



15 16 52 64

TL420VS-4



41 42

TL451VS-3



41 42

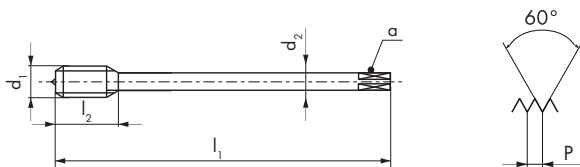

SA420-4

SA450-3

TL420VS-4

TL451VS-3



4HX

4HX

4HX

4HX

$\varnothing d_1$ MF	P mm	$l_1$ mm	$l_2$ mm	$d_2$ mm	a mm		
12	1	100	19	9	7	4	11
12	1.5	100	24	9	7	4	10.5
16	1.5	100	26	12	9	4	14.5

ID	ID	ID	ID
* 152209		* 152218	
	* 152213		
	* 152216		* 152226

6HX

6HX

6HX

6HX

$\varnothing d_1$ MF	P mm	$l_1$ mm	$l_2$ mm	$d_2$ mm	a mm		
12	1	100	19	9	7	4	11
12	1.5	100	24	9	7	4	10.5
14	1.5	100	24	11	9	4	12.5
16	1	100	23	12	9	4	15
16	1.5	100	26	12	9	4	14.5

ID	ID	ID	ID
* 152228		* 152237	
* 152227			
	* 152233	* 152238	
	* 152235		* 152244



PM

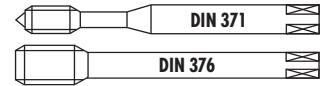

## K

K313TC-3

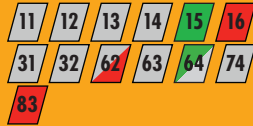
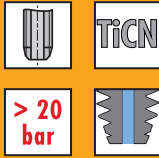

K413TC-3

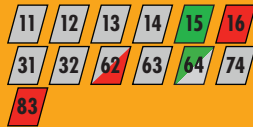
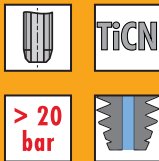

K313TC-3

K413TC-3

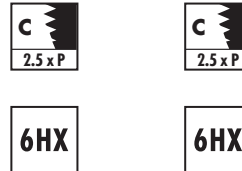
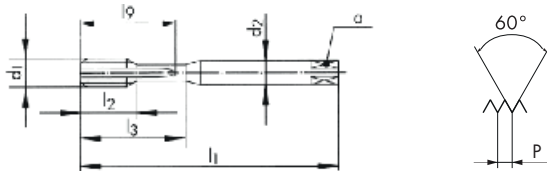

Ø d <sub>1</sub> MF	P mm	l <sub>1</sub> mm	l <sub>2</sub> mm	l <sub>3</sub> mm	l <sub>0</sub> mm	d <sub>2</sub> mm	a mm		
10	1	100	22	39	37	10	8	3	9
10	1.25	100	22	39	37	10	8	3	8.8
12	1	110	24		42	9	7	3	11
12	1.25	110	24		42	9	7	3	10.8
12	1.5	110	24		42	9	7	3	10.5
14	1.5	110	28		49	11	9	3	12.5
16	1.5	110	30		56	12	9	3	14.5
20	1.5	140	36		70	16	12	5	18.5

ID

ID

- 175729
- 196067

- 175731
- 175733
- 175735
- 175737
- 175739
- 171205

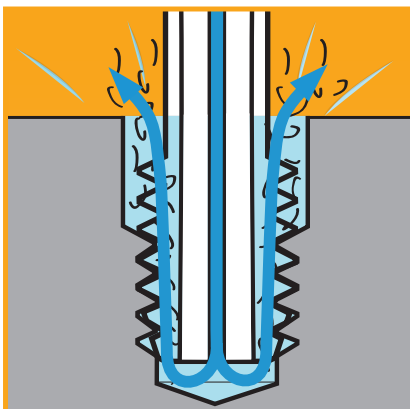





PM

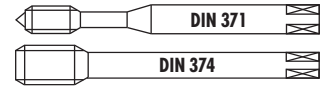

## QTAP

Q320VS-4



Q420VS-4



Q323VS-4

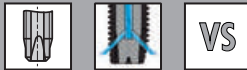

Q423VS-4

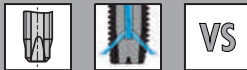

- 11 12 13 14
- 15 21 22 23
- 24 31 32 51
- 52 61 62 63
- 64 71 72 73
- 74 81 82 83
- 91 92 94

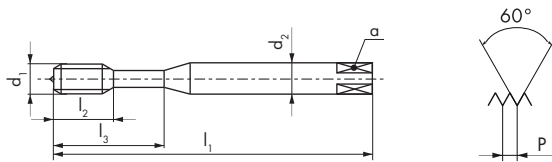

Q320VS-4

Q420VS-4

Q323VS-4

Q423VS-4



NEW



NEW



NEW



NEW



ISO 2  
6H

ISO 2  
6H

ISO 2  
6H

ISO 2  
6H

Ø d <sub>1</sub> MF	P mm	l <sub>1</sub> mm	l <sub>2</sub> mm	l <sub>3</sub> mm	d <sub>2</sub> mm	a mm		
6	0.75	80	17	30	6	4.9	3	5.25
8	1	90	20	35	8	6.2	3	7
10	1	100	22	39	10	8	3	9
12	1	100	24		9	7	3	11
12	1.5	100	24		9	7	3	10.5
14	1.5	100	24		11	9	3	12.5
16	1.5	100	26		12	9	3	14.5
18	1.5	110	26		14	11	4	16.5
20	1.5	125	28		16	12	4	18.5

ID	ID	ID	ID
● 197661		● 197684	
● 197662		● 197685	
● 197663		● 197686	
	● 197664		● 197687
	● 197665		● 197688
	● 197666		● 197689
	● 197667		● 197690
	● 197668		● 197691
	● 197669		● 197692



≤ Ø 16 > Ø 16

PM HSSE

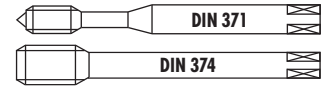

## QTAP

Q360VS-3



Q460VS-3



Q363VS-3



Q463VS-3

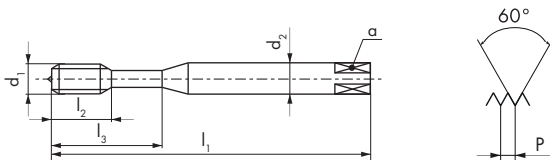
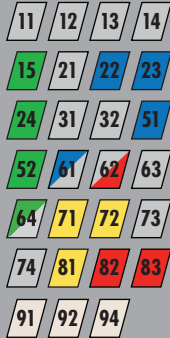

Q360VS-3

Q460VS-3

Q363VS-3

Q463VS-3



NEW



NEW



NEW



NEW



< 2.5 x D



< 2.5 x D



< 2.5 x D



< 2.5 x D



ISO 2 6H



ISO 2 6H



ISO 2 6H



ISO 2 6H

Ø d <sub>1</sub> MF	P mm	l <sub>1</sub> mm	l <sub>2</sub> mm	l <sub>3</sub> mm	d <sub>2</sub> mm	a mm		
4	0.5	63	7.5	21	4.5	3.4	3	3.5
5	0.5	70	9	25	6	4.9	3	4.5
6	0.75	80	11	30	6	4.9	3	5.25
8	1	90	12.5	35	8	6.2	3	7
10	1	100	14	39	10	8	3	9
12	1	100	14		9	7	3	11
12	1.5	100	14		9	7	3	10.5
14	1.5	100	14		11	9	3	12.5
16	1.5	100	14		12	9	4	14.5
18	1.5	110	18		14	11	4	16.5
20	1.5	125	20		16	12	4	18.5
22	1.5	125	20		18	14.5	4	20.5
24	1.5	140	22		18	14.5	4	22.5
24	2	140	22		18	14.5	4	22

ID

ID

ID

ID

● 197670		● 197693	
● 197671		● 197694	
● 197672		● 197695	
● 197673		● 197696	
● 197674		● 197697	
	● 197675		● 197698
	● 197676		● 197699
	● 197677		● 197700
	● 197678		● 197701
	● 197679		● 197702
	● 197680		● 197703
	● 197681		● 197704
	● 197682		● 197705
	● 197683		● 197706



Uniquement pour taraudage synchro  
Nur für Synchrobearbeitung  
Only for rigid tapping  
Solo per mescolatura sincrona  
Solo para resacado sincronizado  
Только для rigid tapping

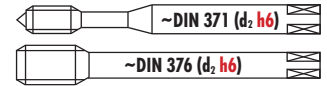

## RTS

Rigid Tapping Synchro

RTS320VS-4		VS	11 12 13 14 15 21 31 32 51 61 63 64 72 73 74 81 82 83 91 92 94	
RTS420VS-4		VS	11 12 13 14 15 21 31 32 51 61 63 64 72 73 74 81 82 83 91 92 94	
RTS362VS-3			VS	11 12 13 14 15 21 31 32 51 61 63 64 72 73 74 81 82 83 91 92 94
RTS462VS-3			VS	11 12 13 14 15 21 31 32 51 61 63 64 72 73 74 81 82 83 91 92 94

RTS320VS-4	RTS420VS-4	RTS362VS-3	RTS462VS-3
------------	------------	------------	------------



		< 2.5 x D	< 2.5 x D

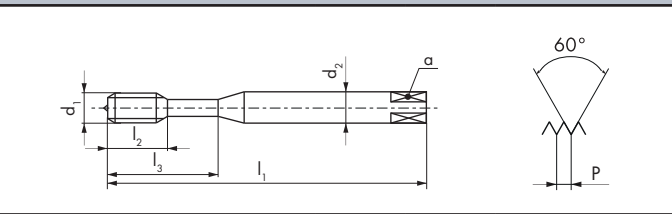

6HX	6HX	6HX	6HX

Ø d <sub>1</sub> MF	P mm	l <sub>1</sub> mm	l <sub>2</sub> mm	l <sub>3</sub> mm	d <sub>2</sub> h6 mm	a mm		
8	1	90	12.5	35	8	6.2	3	7
10	1	100	14	39	10	8	3	9
12	1.5	110	14		* 10	* 8	3	10.5
14	1.5	110	14		* 12	* 9	3	12.5
16	1.5	110	18		12	9	3	14.5
* Norme DC / * DC Norm/ * Norma DC								

ID	ID
● 150615	
● 150630	
	● 150640
	● 150655
	● 150665

Ø d <sub>1</sub> MF	P mm	l <sub>1</sub> mm	l <sub>2</sub> mm	l <sub>3</sub> mm	d <sub>2</sub> h6 mm	a mm		
8	1	90	12.5	35	8	6.2	3	7
10	1	100	14	39	10	8	3	9
12	1.5	110	14		* 10	* 8	3	10.5
14	1.5	110	14		* 12	* 9	3	12.5
16	1.5	110	18		12	9	3	14.5
* Norme DC / * DC Norm/ * Norma DC								

ID	ID
● 150617	
● 150632	
	● 151862
	● 151869
	● 151871

sur demande  
auf Anfrage  
on request  
su richiesta  
sobre pedido  
no zampocy

≥ Ø 6 mm

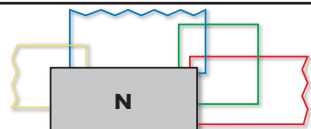

N1110-1



N1110-3



31 62 73 74 91

N1110-S



N1110-1

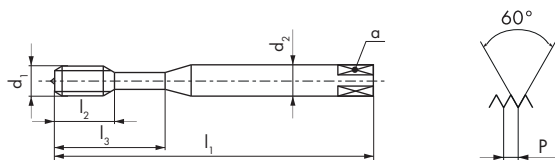

N1110-3

N1110-S



ISO 2  
6H

ISO 2  
6H

Ø d <sub>1</sub> MF	P mm	l <sub>1</sub> mm	l <sub>2</sub> mm	l <sub>3</sub> mm	d <sub>2</sub> mm	a mm		
2	0.25	45	8		2.8	2.1	3	1.75
2.2	0.25	45	9.5		2.8	2.1	3	1.95
2.5	0.35	45	9.5		2.8	2.1	3	2.15
3	0.35	48	11	18	3.15	2.5	3	2.65
3.5	0.35	50	13	20	3.55	2.8	3	3.15
4	0.35	53	13	21	4	3.15	3	3.65
4	0.5	53	13	21	4	3.15	3	3.5
4.5	0.5	53	13	21	4.5	3.55	3	4
5	0.35	58	16	25	5	4	3	4.65
5	0.5	58	16	25	5	4	3	4.5
5	0.75	58	16	25	5	4	3	4.25
5.5	0.5	62	17	26	5.6	4.5	3	5
6	0.5	66	19	30	6.3	5	3	5.5
6	0.75	66	19	30	6.3	5	3	5.25
7	0.5	66	19	30	7.1	5.6	3	6.5
8	0.75	72	22	35	8	6.3	3	7.25
8	1	72	22	35	8	6.3	3	7
9	0.5	72	22	36	9	7.1	3	8.5
9	0.75	72	22	36	9	7.1	3	8.25
9	1	72	22	36	9	7.1	3	8
10	0.5	80	24	39	10	8	3	9.5
10	1	80	24	39	10	8	3	9
10	1.25	80	24	39	10	8	3	8.8

ID

ID

ID

	● 102933	
	● 102936	
	● 102940	
	● 102945	
	● 102949	
	● 102952	
● 102773	● 102953	● 111040
	● 102958	
	● 102960	
● 102778	● 102961	● 111045
	● 102963	
	● 102967	
● 102783	● 102969	● 111050
● 102784	● 102971	● 111051
	● 102975	
● 102790	● 102982	● 111057
● 102791	● 102984	● 111058
	● 102988	
	● 102989	
	● 102990	
	● 102925	
● 102756	● 102928	● 111024
● 102758	● 102930	● 111025

P 0.25

ISO 1  
4H

								N1210-1	N1210-3	N1210-S	
N1210-1											
N1210-3											
N1210-S											
$\emptyset d_1$ MF	P mm	$l_1$ mm	$l_2$ mm	$d_2$ mm	a mm			ID	ID	ID	
11	0.5	85	22	8	6.3	3			● 103485		
11	0.75	85	22	8	6.3	3			● 103486		
11	1	85	22	8	6.3	3			● 103487		
11	1.25	85	22	8	6.3	3			● 103488		
12	0.5	89	24	9	7.1	3			● 103490		
12	0.75	89	24	9	7.1	3			● 103491		
12	1	89	24	9	7.1	3		● 103305	● 103493	● 111169	
12	1.25	89	24	9	7.1	3		● 103307	● 103495	● 111171	
12	1.5	89	24	9	7.1	3		● 103308	● 103497	● 111172	
14	0.5	95	24	11.2	9	3			● 103502		
14	0.75	95	24	11.2	9	3			● 103503		
14	1	95	24	11.2	9	3		● 103312	● 103504	● 111175	
14	1.25	95	24	11.2	9	3		● 103314	● 103506	● 111177	
14	1.5	95	24	11.2	9	3		● 103315	● 103508	● 111178	
15	0.75	90	23	11.2	9	3			● 103512		
15	1	90	23	11.2	9	3			● 103513		
16	0.5	102	32	12.5	10	4			● 103515		
16	0.75	102	32	12.5	10	4			● 103516		
16	1	102	32	12.5	10	4		● 103321	● 103517	● 111183	
16	1.5	102	32	12.5	10	4		● 103322	● 103520	● 111184	
17	1	95	23	12.5	10	4			● 103525		
18	0.75	112	30	14	11.2	4			● 103527		
18	1	112	30	14	11.2	4		● 103326	● 103528	● 111187	
18	1.5	112	30	14	11.2	4		● 103327	● 103531	● 111188	
18	2	112	30	14	11.2	3			● 103533		
19	1	112	33	14	11.2	4			● 103536		



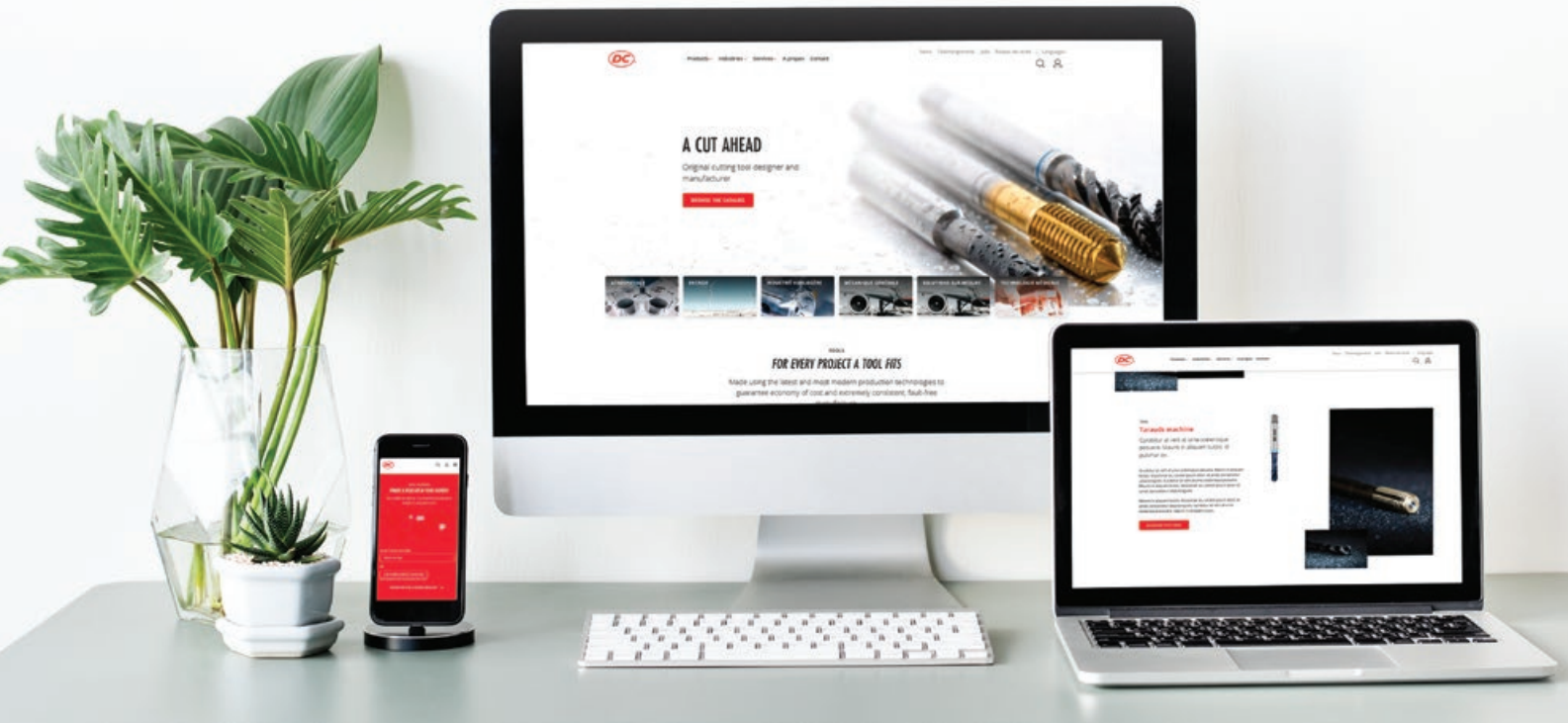

















									N1210-1	N1210-3	N1210-S
<b>N1210-1</b>											
<b>N1210-3</b> <b>31</b> <b>62</b> <b>73</b> <b>74</b> <b>91</b>											
<b>N1210-S</b>											
$\emptyset d_1$ MF	P mm	$l_1$ mm	$l_2$ mm	$d_2$ mm	a mm			ID	ID	ID	
20	1	112	37	14	11.2	4	19	● 103332	● 103537	● 111198	
20	1.25	112	37	14	11.2	4	18.8		● 103539		
20	1.5	112	37	14	11.2	4	18.5	● 103334	● 103540	● 111195	
22	1	115	32	16	12.5	4	21		● 103545		
22	1.5	115	32	16	12.5	4	20.5	● 103340	● 103546	● 121669	
22	2	115	32	16	12.5	3	20		● 103548		
24	1	120	30	18	14	4	23		● 103552		
24	1.5	120	30	18	14	4	22.5	● 103343	● 103553	● 111202	
24	2	130	45	18	14	4	22	● 103344	● 103555	● 111203	
25	1	120	30	18	14	4	24		● 103559		
25	1.5	120	30	18	14	4	23.5		● 103560		
25	2	120	30	18	14	4	23		● 103561		
26	1	120	30	18	14	4	25		● 103562		
26	1.5	120	30	18	14	4	24.5	● 103346	● 103563	● 111207	
26	2	120	30	18	14	4	24		● 103564		
27	1	127	30	20	16	4	26		● 103565		
27	1.5	127	30	20	16	4	25.5		● 103566		
27	2	135	45	20	16	4	25	* 103351	* 103567	* 111210	
28	1	127	30	20	16	4	27		● 103570		
28	1.5	127	30	20	16	4	26.5		● 103571		
30	1.5	127	32	20	16	4	28.5	● 103355	● 103575	● 111214	
30	2	127	32	20	16	4	28	● 103356	● 103577	● 111215	









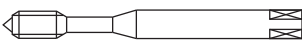
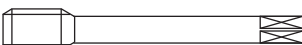



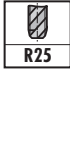
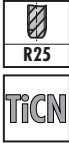

**NEUE WEBSITE**  
**IM AUFBAU — FREIGABE IM SOMMER 2021.**



















**NEW WEBSITE**  
**UNDER CONSTRUCTION — RELEASED IN SUMMER 2021.**



		N						
<b>Merkmale</b> <b>Characteristics</b>								
								
<b>Lochart</b> <b>Hole type</b>								
		<b>N310-3</b>	<b>N320-3</b> <b>N320-4</b>	<b>N320V-4</b>	<b>N320TN-4</b>	<b>N360-3</b>	<b>N360V-3</b>	<b>N360TN-3</b>
<b>DIN lang</b> <b>DIN long</b>	<b>DIN 371</b>	154	154	154	154	156	156	156
<b>ISO kurz</b> <b>ISO short</b>	<b>ISO 529</b>							
<b>Toleranz</b> <b>Tolerance</b>	<b>UNC 2B</b>	154	154	154	154	156	156	156
<b>Toleranz</b> <b>Tolerance</b>	<b>UNC 3B</b>							
<b>Toleranz</b> <b>Tolerance</b>	<b>UNC(J) 3B</b>		154			156		
		<b>N410-3</b>	<b>N420-4</b>	<b>N420V-4</b>	<b>N420TN-4</b>	<b>N460-3</b>	<b>N460V-3</b>	<b>N460TN-3</b>
<b>DIN lang</b> <b>DIN long</b>	<b>DIN 376</b>	155	155	155	155	157	157	157
<b>ISO kurz</b> <b>ISO short</b>	<b>ISO 529</b>							
<b>Toleranz</b> <b>Tolerance</b>	<b>UNC 2B</b>	155	155	155	155	157	157	157
<b>Toleranz</b> <b>Tolerance</b>	<b>UNC 3B</b>							
<b>Toleranz</b> <b>Tolerance</b>	<b>UNC(J) 3B</b>							

N	Z				H			
	 V	 VS	 R40 V	 R45 VS		 TiCN	 R25	 R25 TiCN
						 <b>NEW</b>		 <b>NEW</b>
								
<b>N1110</b> -1 -2 -3 -S	<b>Z320V-3</b> <b>Z320V-4</b>	<b>Z320VS-4</b>	<b>Z360V-3</b> <b>Z362V-3</b>	<b>Z370VS-3</b>	<b>H320-4</b>	<b>H320TC-4</b>	<b>H350-3</b>	<b>H350TC-3</b>
	158	158	159	160	161	161	162	162
170								
170	158	158	159	160	161	161	162	162
				160				
<b>N1210</b> -1 -2 -3 -S	<b>Z420V-4</b>	<b>Z420VS-4</b>	<b>Z462V-3</b>	<b>Z470VS-3</b>	<b>H420-4</b>	<b>H420TC-4</b>	<b>H450-3</b>	<b>H450TC-3</b>
	158	158	159	160	161	161	162	162
171								
171	158	158	159	160	161	161	162	162

		S		SA			TL	
<b>Merkmale</b> <b>Characteristics</b>								
<b>Lochart</b> <b>Hole type</b>								
		<b>S320VS-4</b>	<b>S360VS-3</b>	<b>SA320-4</b>	<b>SA350-3</b>	<b>SA390-3</b>	<b>TL320VS-4</b>	<b>TL351VS-3</b>
<b>DIN lang</b> <b>DIN long</b>	DIN 371	163	164	165	165	166	165	165
<b>ISO kurz</b> <b>ISO short</b>	ISO 529							
<b>Toleranz</b> <b>Tolerance</b>	UNC 2B	163	164	165	165		165	165
<b>Toleranz</b> <b>Tolerance</b>	UNC 3B							
<b>Toleranz</b> <b>Tolerance</b>	UNC(J) 3B	163		165	165	166	165	165
		<b>S420VS-4</b>	<b>S460VS-3</b>	<b>SA420-4</b>	<b>SA450-3</b>			
<b>DIN lang</b> <b>DIN long</b>	DIN 376	163	164	166	166			
<b>ISO kurz</b> <b>ISO short</b>	ISO 529							
<b>Toleranz</b> <b>Tolerance</b>	UNC 2B	163	164	166	166			
<b>Toleranz</b> <b>Tolerance</b>	UNC 3B							
<b>Toleranz</b> <b>Tolerance</b>	UNC(J) 3B							

Q				RTS	
					
VS	VS	VS	VS	VS	VS
					
<b>NEW</b>	<b>NEW</b>	<b>NEW</b>	<b>NEW</b>		
					
<b>Q320VS-4</b>	<b>Q323VS-4</b>	<b>Q360VS-3</b>	<b>Q363VS-3</b>	<b>RTS320VS-4</b>	<b>RTS362VS-3</b>
167	167	168	168	169	169
167	167	168	168	169	169
<b>Q420VS-4</b>	<b>Q423VS-4</b>	<b>Q460VS-3</b>	<b>Q463VS-3</b>	<b>RTS420VS-4</b>	<b>RTS462VS-3</b>
167	167	168	168	169	169
167	167	168	168	169	169

# UNC ASME B1.1

≤ Ø 2.8 > Ø 2.8

PM HSSE

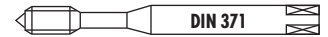

										N310-3	N320-4	N320V-4	N320TN-4
N310-3													
N320-4													
N320V-4													
N320TN-4													
Ø" d <sub>1</sub> UNC	P TPI	d <sub>1</sub> mm	l <sub>1</sub> mm	l <sub>2</sub> mm	l <sub>3</sub> mm	d <sub>2</sub> mm	a mm			ID	ID	ID	ID
* 2	56	2.18	45	9		2.8	2.1	2	1.75		● 101469	● 143690	
* 3	48	2.51	50	10		2.8	2.1	2	2		● 101470		
4	40	2.84	56	12	18	3.5	2.7	3	2.25	● 101450	● 101511	● 142738	
5	40	3.17	56	12	18	3.5	2.7	3	2.55		● 101512		
6	32	3.5	56	13	20	4	3	3	2.75	● 101451	● 101514	● 144402	● 196003
8	32	4.16	63	14	21	4.5	3.4	3	3.4	● 101452	● 101515	● 142739	● 196004
10	24	4.82	70	15	25	6	4.9	3	3.8	● 101449	● 101508	● 142740	● 196005
12	24	5.48	80	17	30	6	4.9	3	4.4		● 101509		
1/4	20	6.35	80	17	30	7	5.5	3	5.1	● 101448	● 101507	● 142741	● 196006
Ø d <sub>1</sub> UNC	P TPI	d <sub>1</sub> mm	l <sub>1</sub> mm	l <sub>2</sub> mm	l <sub>3</sub> mm	d <sub>2</sub> mm	a mm			ID			
4	40	2.84	56	12	18	3.5	2.7	3	2.3	● 145656			
6	32	3.5	56	13	20	4	3	3	2.8	● 155317			
8	32	4.16	63	14	21	4.5	3.4	3	3.45	● 155319			
* N320-3 / N320V-3													

# UNC ASME B1.1

HSSE



										N410-3	N420-4	N420V-4	N420TN-4
										N410-3		31 62 73 74 91	
N420-4		62 63 64 72 73 74 81 91											
N420V-4		V	11 12 31 32										
N420TN-4		TiN	11 12 13 14 32							NEW			
										2B	2B	2B	2B
$\emptyset'' d_1$ UNC	P TPI	$d_1$ mm	$l_1$ mm	$l_2$ mm	$d_2$ mm	a mm				ID	ID	ID	ID
5/16	18	7.93	90	20	6	4.9	3	6.5	● 101997	● 102213	● 142742	● 196007	
3/8	16	9.52	100	22	7	5.5	3	8	● 101996	● 102212	● 142743	● 158317	
7/16	14	11.11	100	19	8	6.2	3	9.3		● 102215	● 142744	● 196008	
1/2	13	12.7	110	24	9	7	3	10.8	● 101993	● 102208	● 142745	● 143827	
9/16	12	14.28	110	28	11	9	3	12.2		● 102217			
5/8	11	15.87	110	30	12	9	3	13.6	● 101998	● 102214	● 142746	● 146391	
3/4	10	19.05	125	33	14	11	3	16.6	● 101995	● 102211	● 142747	● 146054	
7/8	9	22.22	140	36	18	14.5	3	19.5		● 102216	● 142748		
1	8	25.4	160	39	18	14.5	4	22.3	● 101994	● 102209	● 142749		
1 1/8	7	28.57	180	45	22	18	4	25		● 102205			
1 1/4	7	31.75	180	45	22	18	4	28.2		● 102204			
1 1/2	6	38.1	200	55	32	24	4	34		● 102203			
1 3/4	5	44.45	220	59	36	29	4	39.5	★ 101992	● 102206			
2	4.5	50.8	250	67	40	32	4	45.3		● 102210			

UNC, UNC(I)

# UNC ASME B1.1

≤ Ø 2.8 > Ø 2.8

PM HSSE

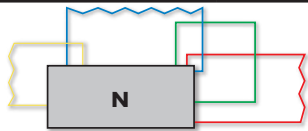
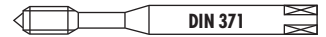

N360-3		63 72 73 74 81 91
N360V-3		11 12 32
N360TN-3		11 12 13 14 32
N360-3		63 72 73 74 81 91

N360-3	N360V-3	N360TN-3	N360-3
< 2.5 x D	< 2.5 x D	< 2.5 x D	< 2.5 x D

NEW

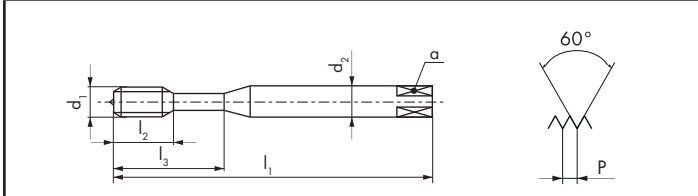

2B	2B	2B	3B UNC(J)

Ø" d <sub>1</sub> UNC	P TPI	d <sub>1</sub> mm	l <sub>1</sub> mm	l <sub>2</sub> mm	l <sub>3</sub> mm	d <sub>2</sub> mm	a mm			ID	ID	ID	ID
2	56	2.18	45	8		2.8	2.1	2	1.75	● 101673	● 148887		
3	48	2.51	50	9		2.8	2.1	2	2	● 101674			
4	40	2.84	56	5.5	18	3.5	2.7	3	<sup>1</sup> 2.25	● 101676	● 101725		● 155316
5	40	3.17	56	5.5	18	3.5	2.7	3	2.55	● 101677			
6	32	3.5	56	6.5	20	4	3	3	<sup>2</sup> 2.75	● 101679	● 101727	● 195998	● 155318
8	32	4.16	63	7.5	21	4.5	3.4	3	<sup>3</sup> 3.4	● 101680	● 101728	● 150558	● 155320
10	24	4.82	70	9	25	6	4.9	3	3.8	● 101671	● 101723	● 195999	
12	24	5.48	80	11	30	6	4.9	3	4.4	● 101672			
1/4	20	6.35	80	11	30	7	5.5	3	5.1	● 101670	● 101722	● 196000	
5/16	18	7.93	90	12.5	35	8	6.2	3	6.5	● 101678	● 101726	● 196001	
3/8	16	9.52	100	14	39	10	8	3	8	● 101675	● 101724	● 164171	

UNJC  
<sup>1</sup> 2.3  
<sup>2</sup> 2.8  
<sup>3</sup> 3.45



# UNC ASME B1.1

HSSE



										N460-3	N460V-3	N460TN-3
										<div style="display: flex; justify-content: space-around;"> </div>		
<div style="display: flex; justify-content: space-around;"> <span>63 72 73 74 81 91</span> </div>												
<div style="display: flex; justify-content: space-around;"> <span>11 12 32</span> </div>												
<div style="display: flex; justify-content: space-around;"> <span>11 12 13 14 32</span> </div>												
Ø" d <sub>1</sub> UNC	P TPI	d <sub>1</sub> mm	l <sub>1</sub> mm	l <sub>2</sub> mm	d <sub>2</sub> mm	a mm			ID	ID	ID	
7/16	14	11.11	100	14	8	6.2	3	9.3	● 102424	● 105135	● 196002	
1/2	13	12.7	110	14	9	7	3	10.8	● 102420	● 102497	● 157376	
9/16	12	14.28	110	14	11	9	3	12.2	● 102426	● 102502		
5/8	11	15.87	110	18	12	9	3	13.6	● 102423	● 102500	● 128252	
3/4	10	19.05	125	21	14	11	3	16.6	● 102422	● 102499	● 143519	
7/8	9	22.22	140	24	18	14.5	4	19.5	● 102425	● 102501		
1	8	25.4	160	27	18	14.5	4	22.3	● 102421	● 102498		
1 1/8	7	28.57	180	30	22	18	4	25	● 102418	● 102495		
1 1/4	7	31.75	180	30	22	18	4	28.2	● 102417	● 102494		
1 1/2	6	38.1	200	40	32	24	5	34	● 102416	● 102493		
1 3/4	5	44.45	220	44	36	29	5	39.5		● 128062		
2	4.5	50.8	250	52	40	32	5	45.3		● 128084		

UNC, UNC(I)

# UNC ASME B1.1

PM

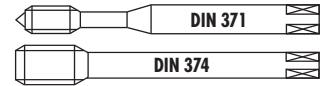

										Z320V-4	Z320VS-4	Z420V-4	Z420VS-4				
Z320V-4		V	11	12	13	21	32										
Z320VS-4		VS	11	12	13	14	21	22	23	32	61	63	94				
Z420V-4		V	11	12	13	21	32										
Z420VS-4		VS	11	12	13	14	21	22	23	32	61	63	94				
										2B	2B	2B	2B				
Ø" d <sub>1</sub> UNC	P TPI	d <sub>1</sub> mm	l <sub>1</sub> mm	l <sub>2</sub> mm	l <sub>3</sub> mm	d <sub>2</sub> mm	a mm			ID	ID	ID	ID				
* 2	56	2.18	45	9		2.8	2.1	2	1.75	● 142750							
4	40	2.84	56	12	18	3.5	2.7	3	2.25	● 142751							
6	32	3.5	56	13	20	4	3	3	2.75	● 142752	● 111560						
8	32	4.16	63	14	21	4.5	3.4	3	3.4	● 142753	● 111561						
10	24	4.82	70	15	25	6	4.9	3	3.8	● 142754	● 111562						
1/4	20	6.35	80	17	30	7	5.5	3	5.1	● 142755	● 111563						
5/16	18	7.93	90	20	35	8	6.2	3	6.5	● 142756	● 111564						
3/8	16	9.52	100	22	39	10	8	3	8	● 142757	● 111565						
7/16	14	11.11	100	19		8	6.2	3	9.3					● 196028			
1/2	13	12.7	110	24		9	7	3	10.8					● 142758	● 111566		
5/8	11	15.87	110	30		12	9	3	13.6					● 142759	● 111567		
3/4	10	19.05	125	33		14	11	4	16.6					● 142760	● 111568		
7/8	9	22.22	140	36		18	14.5	4	19.5					● 142761			
1	8	25.4	160	39		18	14.5	4	22.3					● 142762			

\* Z320V-3 2.5 x P

# UNC ASME B1.1

≤ Ø 2.8 > Ø 2.8

PM

HSSE

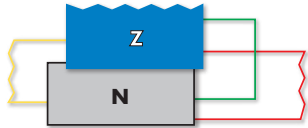

Z362V-3



Z462V-3



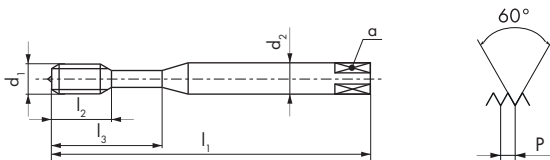

Z362V-3

Z462V-3



2B

2B

Ø" d <sub>1</sub> UNC	P TPI	d <sub>1</sub> mm	l <sub>1</sub> mm	l <sub>2</sub> mm	l <sub>3</sub> mm	d <sub>2</sub> mm	a mm			ID	ID
* 2	56	2.18	45	8		2.8	2.1	2	1.75	● 104695	
* 4	40	2.84	56	5.5	18	3.5	2.7	3	2.25	● 104697	
6	32	3.5	56	6.5	20	4	3	3	2.75	● 104699	
8	32	4.16	63	7.5	21	4.5	3.4	3	3.4	● 104700	
10	24	4.82	70	9	25	6	4.9	3	3.8	● 104694	
1/4	20	6.35	80	11	30	7	5.5	3	5.1	● 104693	
5/16	18	7.93	90	12.5	35	8	6.2	3	6.5	● 104698	
3/8	16	9.52	100	14	39	10	8	3	8	● 104696	
7/16	14	11.11	100	14		8	6.2	3	9.3		● 104757
1/2	13	12.7	110	14		9	7	3	10.8		● 104753
5/8	11	15.87	110	18		12	9	3	13.6		● 104756
3/4	10	19.05	125	21		14	11	3	16.6		● 104755
7/8	9	22.22	140	24		18	14.5	3	19.5		● 104758
1	8	25.4	160	27		18	14.5	4	22.3		● 104754

\* Z360V-3

UNC, UNC(I)

# UNC ASME B1.1

PM

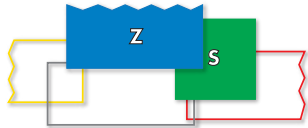
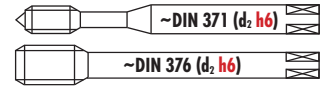

Z370VS-3



Z470VS-3



Z370VS-3



Z470VS-3



Z370VS-3

Z470VS-3

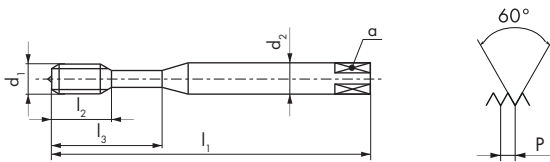

2BX

2BX

Ø" d <sub>1</sub> UNC	P TPI	d <sub>1</sub> mm	l <sub>1</sub> mm	l <sub>2</sub> mm	l <sub>3</sub> mm	d <sub>2</sub> h <sub>6</sub> mm	a mm			ID
6	32	3.5	56	6.5	20	4 (h9)	3	3	2.75	● 166123
8	32	4.16	63	7.5	21	4.5(h9)	3.4	3	3.4	● 166124
10	24	4.82	70	9	25	6	4.9	3	3.8	● 166125
1/4	20	6.35	80	11	30	*6	*4.9	3	5.1	● 166126
5/16	18	7.93	90	12.5	35	8	6.2	3	6.5	● 166127
3/8	16	9.52	100	14	39	10	8	3	8	● 166128
7/16	14	11.11	100	14		8	6.2	3	9.3	● 166129
1/2	13	12.7	110	14		*10	*8	4	10.8	● 166130
5/8	11	15.87	110	18		12	9	4	13.6	● 166131
3/4	10	19.05	125	21		14	11	4	16.6	● 166132
1	8	25.4	160	27		16	12	4	22.3	● 175703

\* Norme DC / \* DC Norm/ \* Norma DC

3B  
UNC(J)

Ø" d <sub>1</sub> UNC	P TPI	d <sub>1</sub> mm	l <sub>1</sub> mm	l <sub>2</sub> mm	l <sub>3</sub> mm	d <sub>2</sub> h <sub>6</sub> mm	a mm			ID
4	40	2.84	56	5.5	18	3.5(h9)	2.7	3	2.3	● 165114
6	32	3.5	56	6.5	20	4 (h9)	3	3	2.8	● 165115
8	32	4.16	63	7.5	21	4.5(h9)	3.4	3	3.45	● 165116
1/4	20	6.35	80	11	30	*6	*4.9	3	5.2	● 165117
5/16	18	7.93	90	12.5	35	8	6.2	3	6.7	● 165118

\* Norme DC / \* DC Norm/ \* Norma DC

# UNC ASME B1.1

PM

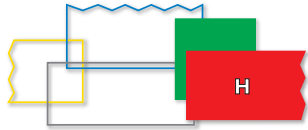
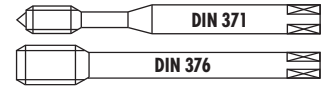

H320-4		15 16 62 64 82
H420-4		15 16 62 64 82
H320TC-4	TiCN	15 16 24 31 82 83 92 93
H420TC-4	TiCN	15 16 24 31 82 83 92 93

H320-4	H420-4	H320TC-4	H420TC-4
--------	--------	----------	----------

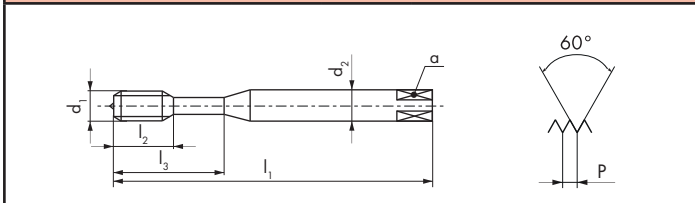
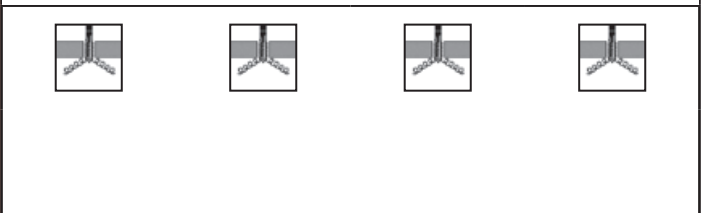

2B	2B	2B	2B

Ø" d <sub>1</sub> UNC	P TPI	d <sub>1</sub> mm	l <sub>1</sub> mm	l <sub>2</sub> mm	l <sub>3</sub> mm	d <sub>2</sub> mm	a mm			ID	ID	ID	ID
2	56	2.18	45	8		2.8	2.1	2	1.75	● 101221			
4	40	2.84	56	10	18	3.5	2.7	3	2.25	● 101223			
6	32	3.5	56	13	20	4	3	3	2.75	● 101225		● 196046	
8	32	4.16	63	14	21	4.5	3.4	3	3.4	● 101226		● 196047	
10	24	4.82	70	15	25	6	4.9	3	3.8	● 101220		● 196048	
1/4	20	6.35	80	17	30	7	5.5	3	5.1	● 101219		● 196049	
5/16	18	7.93	90	20	35	8	6.2	3	6.5	● 101224		● 143730	
3/8	16	9.52	100	22	39	10	8	3	8	● 101222		● 196050	
7/16	14	11.11	100	19		8	6.2	3	9.3		● 196051		● 196052
1/2	13	12.7	110	24		9	7	4	10.8		● 101290		● 143731
5/8	11	15.87	110	30		12	9	4	13.6		● 163741		● 196053
3/4	10	19.05	125	33		14	11	4	16.6		● 163743		● 196054

UNC, UNC(I)

# UNC ASME B1.1

PM

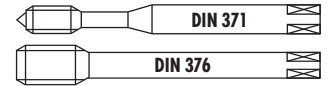

H350-3		15 16 62 64 82
H450-3		15 16 62 64 82
H350TC-3		15 16 24 31 82 83 92 93
H450TC-3		15 16 24 31 82 83 92 93

H350-3	H450-3	H350TC-3	H450TC-3
		<b>NEW</b>	<b>NEW</b>
< 1.5 x D	< 1.5 x D	< 1.5 x D	< 1.5 x D

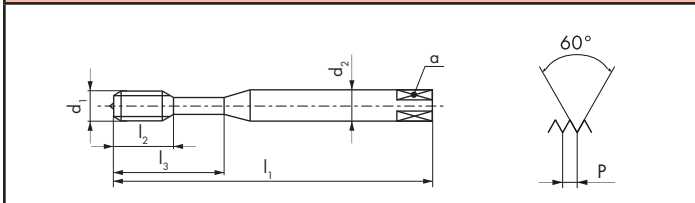

<b>2B</b>	<b>2B</b>	<b>2B</b>	<b>2B</b>

Ø" d <sub>1</sub> UNC	P TPI	d <sub>1</sub> mm	l <sub>1</sub> mm	l <sub>2</sub> mm	l <sub>3</sub> mm	d <sub>2</sub> mm	a mm			ID	ID	ID	ID
2	56	2.18	45	8		2.8	2.1	2	1.75	● 101258			
4	40	2.84	56	5.5	18	3.5	2.7	3	2.25	● 101260			
6	32	3.5	56	6.5	20	4	3	3	2.75	● 101262		● 196040	
8	32	4.16	63	7.5	21	4.5	3.4	3	3.4	● 101263		● 196041	
10	24	4.82	70	9	25	6	4.9	3	3.8	● 101257		● 196042	
1/4	20	6.35	80	11	30	7	5.5	3	5.1	● 101256		● 160585	
5/16	18	7.93	90	12.5	35	8	6.2	3	6.5	● 101261		● 160587	
3/8	16	9.52	100	14	39	10	8	3	8	● 101259		● 162106	
7/16	14	11.11	100	14		8	6.2	3	9.3		● 101330		● 196043
1/2	13	12.7	110	14		9	7	4	10.8		● 101326		● 160586
5/8	11	15.87	110	18		12	9	4	13.6		● 101329		● 196044
3/4	10	19.05	125	21		14	11	4	16.6		● 101328		● 196045
1	8	25.4	160	27		18	14.5	4	22.3		● 101327		

# UNC ASME B1.1

PM

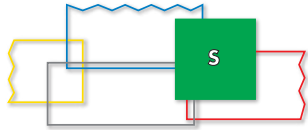
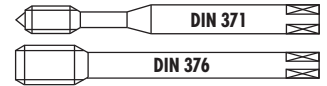

S320VS-4



13 15 16 22 23 24  
52

S420VS-4



13 15 16 22 23 24  
52

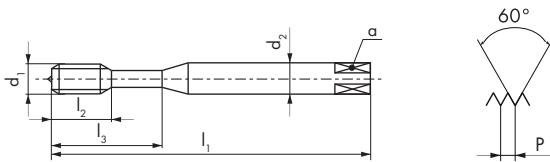

S320VS-4

S420VS-4



2B

2B

Ø" d <sub>1</sub> UNC	P TPI	d <sub>1</sub> mm	l <sub>1</sub> mm	l <sub>2</sub> mm	l <sub>3</sub> mm	d <sub>2</sub> mm	a mm		
6	32	3.5	56	13	20	4	3	3	2.75
8	32	4.16	63	14	21	4.5	3.4	3	3.4
1/4	20	6.35	80	17	30	7	5.5	3	5.1
5/16	18	7.93	90	20	35	8	6.2	3	6.5
3/8	16	9.52	100	22	39	10	8	3	8
1/2	13	12.7	110	24		9	7	4	10.8
5/8	11	15.87	110	30		12	9	4	13.6
3/4	10	19.05	125	33		14	11	4	16.6

ID

ID

● 111587

● 111588

● 111590

● 111591



● 111592

● 111593

● 111594

● 111595

3B  
UNC(J)

Ø" d <sub>1</sub> UNC	P TPI	d <sub>1</sub> mm	l <sub>1</sub> mm	l <sub>2</sub> mm	l <sub>3</sub> mm	d <sub>2</sub> mm	a mm		
4	40	2.84	56	12	18	3.5	2.7	3	2.3
6	32	3.5	56	13	20	4	3	3	2.8
8	32	4.16	63	14	21	4.5	3.4	3	3.45
1/4	20	6.35	80	17	30	7	5.5	3	5.2
5/16	18	7.93	90	20	35	8	6.2	3	6.7

ID

● 165314

● 165315

● 165316

● 165317

\* 143761

UNC, UNC(J)



# UNC ASME B1.1

PM

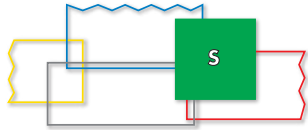
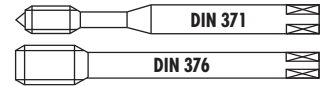

S360VS-3



13 15 16 22 23 24  
52

S460VS-3



13 15 16 22 23 24  
52

S360VS-3

S460VS-3

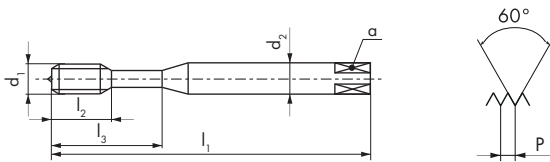

2B

2B

Ø" d <sub>1</sub> UNC	P TPI	d <sub>1</sub> mm	l <sub>1</sub> mm	l <sub>2</sub> mm	l <sub>3</sub> mm	d <sub>2</sub> mm	a mm		
6	32	3.5	56	6.5	20	4	3	3	2.75
8	32	4.16	63	7.5	21	4.5	3.4	3	3.4
1/4	20	6.35	80	11	30	7	5.5	3	5.1
5/16	18	7.93	90	12.5	35	8	6.2	3	6.5
3/8	16	9.52	100	14	39	10	8	3	8
1/2	13	12.7	110	14		9	7	4	10.8

ID

ID

• 111530

• 111531

• 111533

• 111534

• 111535

• 111537

## aero

SA320-4



15 16 52 64

SA350-3



15 16 52 64

TL320VS-4



41 42

TL351VS-3



41 42

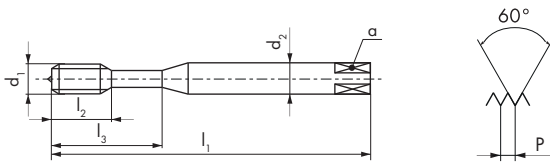

SA320-4

SA350-3

TL320VS-4

TL351VS-3



2B

2B

2B

2B

Ø" d <sub>1</sub> UNC	P TPI	d <sub>1</sub> mm	l <sub>1</sub> mm	l <sub>2</sub> mm	l <sub>3</sub> mm	d <sub>2</sub> mm	a mm		
4	40	2.84	56	12		3.5	2.7	3	2.25
5	40	3.17	56	12		3.5	2.7	3	2.55
6	32	3.5	56	13		4	3	3	2.75
8	32	4.16	63	14		4.5	3.4	3	3.4
10	24	4.82	70	15		6	4.9	3	3.8
1/4	20	6.35	80	15	23	7	5.5	3	5.1
5/16	18	7.93	90	18	29	8	6.2	3	6.5
3/8	16	9.52	100	20	33	10	8	3	8

ID

ID

ID

ID

● 147271	● 149003		● 152018
		* 152023	* 152024
● 149055	● 149057	* 152027	● 152028
● 149093	● 149095		● 152037
● 149125	* 149127		
● 149222	● 149224		● 127972
● 149269	● 149271		● 152068
● 149346	● 149348	* 152084	● 152085

3B  
UNC(J)

3B  
UNC(J)

3B  
UNC(J)

3B  
UNC(J)

Ø" d <sub>1</sub> UNC	P TPI	d <sub>1</sub> mm	l <sub>1</sub> mm	l <sub>2</sub> mm	l <sub>3</sub> mm	d <sub>2</sub> mm	a mm		
4	40	2.84	56	12		3.5	2.7	3	2.3
6	32	3.5	56	13		4	3	3	2.8
8	32	4.16	63	14		4.5	3.4	3	3.45
10	24	4.82	70	15		6	4.9	3	3.9
1/4	20	6.35	80	15	23	7	5.5	3	5.2
5/16	18	7.93	90	18	29	8	6.2	3	6.7
3/8	16	9.52	100	20	33	10	8	3	8.1

ID

ID

ID

ID

● 149005	● 149007	* 148804	● 150194
● 149059	● 149061	* 152029	● 150210
● 149097	● 149099		● 152039
			* 152045
● 149226	● 149228	* 152063	● 152064
● 149273	● 149275	* 152069	● 152070
● 149350	● 149352		● 152087

UNC, UNC(J)



## aero

SA420-4



15 16 52 64

SA450-3



15 16 52 64

SA390-3



16 53

SA420-4

SA450-3

SA390-3



2B

2B

3B  
UNC(J)

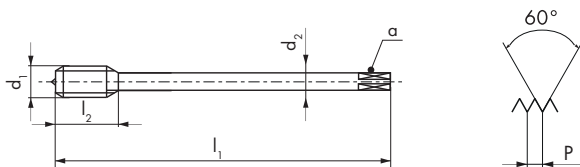

Ø" d <sub>1</sub> UNC	P TPI	d <sub>1</sub> mm	l <sub>1</sub> mm	l <sub>2</sub> mm	d <sub>2</sub> mm	a mm		
1/2	13	12.7	110	24	9	7	4	10.8
5/8	11	15.87	110	30	12	9	4	13.6

ID	ID
● 152247	● 152252
● 152249	● 152254

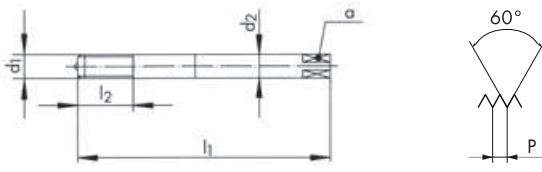

Ø" d <sub>1</sub> UNC	P TPI	d <sub>1</sub> mm	l <sub>1</sub> mm	l <sub>2</sub> mm	d <sub>2</sub> mm	a mm		
4	40	2.84	56	12	3.5	2.7	3	2.3
6	32	3.5	56	13	4	3	3	2.8
8	32	4.16	63	14	4.5	3.4	3	3.45
10	24	4.82	70	15	6	4.9	3	3.9
1/4	20	6.35	80	20	7	5.5	3	5.2
5/16	18	7.93	90	25	8	6.2	3	6.7
3/8	16	9.52	100	30	10	8	3	8.1

ID
● 149652
● 149666
● 149677
● 149685
● 149713
● 149726
● 149747



PM

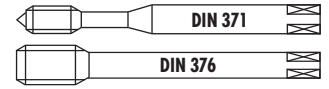

## QTAP

Q320VS-4



Q420VS-4



Q323VS-4

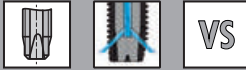

Q423VS-4

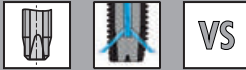

- 11 12 13 14
- 15 21 22 23
- 24 31 32 51
- 52 61 62 63
- 64 71 72 73
- 74 81 82 83
- 91 92 94

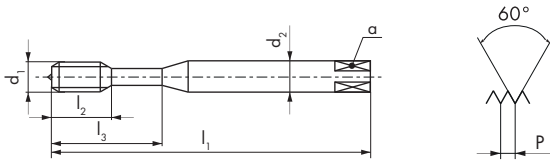

Q320VS-4

Q420VS-4

Q323VS-4

Q423VS-4



NEW



NEW



NEW



NEW



2B

2B

2B

2B

Ø" d <sub>1</sub> UNC	P TPI	d <sub>1</sub> mm	l <sub>1</sub> mm	l <sub>2</sub> mm	l <sub>3</sub> mm	d <sub>2</sub> mm	a mm		
6	32	3.5	56	13	20	4	3	3	2.75
8	32	4.16	63	14	21	4.5	3.4	3	3.4
10	24	4.82	70	15	25	6	4.9	3	3.8
1/4	20	6.35	80	17	30	7	5.5	3	5.1
5/16	18	7.93	90	20	35	8	6.2	3	6.5
3/8	16	9.52	100	22	39	10	8	3	8
1/2	13	12.7	110	24		9	7	3	10.8
5/8	11	15.87	110	30		12	9	3	13.6
3/4	10	19.05	125	33		14	11	4	16.6
7/8	9	22.22	140	36		18	14.5	4	19.5
1	8	25.4	160	39		18	14.5	4	22.3

ID

ID

ID

ID

● 196275

● 196320

● 196276

● 196321

● 196277

● 196322

● 196278

● 196323

● 196279

● 196324

● 196280

● 196325

● 196281 ● 196326

● 196282 ● 196327

● 196283 ● 196328

● 196284 ● 196329

● 196285 ● 196330

UNC, UNC(I)



≤ Ø 16 > Ø 16

PM HSSE

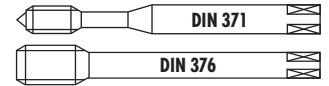

## QTAP

**Q360VS-3**

**Q460VS-3**

**Q363VS-3**

**Q463VS-3**

11 12 13 14  
15 21 22 23  
24 31 32 51  
52 61 62 63  
64 71 72 73  
74 81 82 83  
91 92 94

Q360VS-3	Q460VS-3	Q363VS-3	Q463VS-3
----------	----------	----------	----------

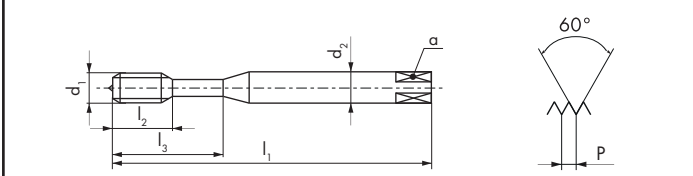
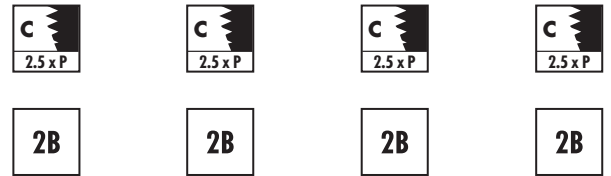

Ø" d <sub>1</sub> UNC	P TPI	d <sub>1</sub> mm	l <sub>1</sub> mm	l <sub>2</sub> mm	l <sub>3</sub> mm	d <sub>2</sub> mm	a mm			ID	ID	ID	ID
6	32	3.5	56	6.5	20	4	3	3	2.75	● 196286		● 196331	
8	32	4.16	63	7.5	21	4.5	3.4	3	3.4	● 196287		● 196332	
10	24	4.82	70	9	25	6	4.9	3	3.8	● 196288		● 196333	
1/4	20	6.35	80	11	30	7	5.5	3	5.1	● 196289		● 197622	
5/16	18	7.93	90	12.5	35	8	6.2	3	6.5	● 196290		● 197623	
3/8	16	9.52	100	14	39	10	8	3	8	● 196291		● 197624	
7/16	14	11.11	100	14		8	6.2	3	9.3		● 196292		● 197625
1/2	13	12.7	110	14		9	7	3	10.8		● 196293		● 197626
5/8	11	15.87	110	18		12	9	3	13.6		● 196294		● 197627
3/4	10	19.05	125	21		14	11	3	16.6		● 196295		● 197628
7/8	9	22.22	140	24		18	14.5	3	19.5		● 196296		● 197629
1	8	25.4	160	27		18	14.5	4	22.3		● 196297		● 197630

# UNC ASME B1.1



Uniquement pour taraudage synchro  
 Nur für Synchrobearbeitung  
 Only for rigid tapping  
 Solo per mescolatura sincrona  
 Solo para resacado sincronizado  
 Только для rigid tapping

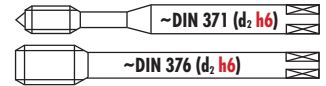

## RTS Rigid Tapping Synchro

RTS320VS-4



RTS420VS-4



RTS362VS-3



RTS462VS-3



RTS320VS-4

RTS420VS-4

RTS362VS-3

RTS462VS-3

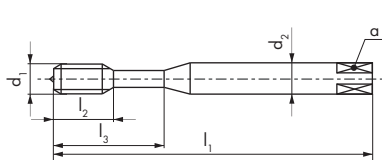

Ø" d <sub>1</sub> UNC	P TPI	d <sub>1</sub> mm	l <sub>1</sub> mm	l <sub>2</sub> mm	l <sub>3</sub> mm	d <sub>2</sub> h <sub>6</sub> mm	a mm			
6	32	3.5	56	6.5	20	4 (h9)	3	3	2.75	● 157395
8	32	4.16	63	7.5	21	4.5(h9)	3.4	3	3.4	● 157396
10	24	4.82	70	9	25	6	4.9	3	3.8	● 157397
1/4	20	6.35	80	11	30	* 6	* 4.9	3	5.1	● 157398
5/16	18	7.93	90	12.5	35	8	6.2	3	6.5	● 157399
3/8	16	9.52	100	14	39	10	8	3	8	● 157400
1/2	13	12.7	110	14		* 10	* 8	3	10.8	● 157401

ID	ID	ID	ID
● 157395		● 157402	
● 157396		● 157403	
● 157397		● 157404	
● 157398		● 157405	
● 157399		● 157406	
● 157400		● 157407	
	● 157401		● 157408

\* Norme DC / \* DC Norm/ \* Norma DC



sur demande  
 auf Anfrage  
 on request  
 su richiesta  
 sobre pedido  
 no zapyty

≥ Ø 6 mm

UNC, UNC(I)

# UNC ASME B1.1

≤ Ø 2.8 > Ø 2.8

PM HSS

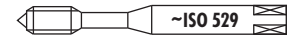

										N1110-1	N1110-2	N1110-3	N1110-S
										N1110-1			
N1110-2													
N1110-3													
N1110-S													
Ø" d <sub>1</sub> UNC	P TPI	d <sub>1</sub> mm	l <sub>1</sub> mm	l <sub>2</sub> mm	l <sub>3</sub> mm	d <sub>2</sub> mm	a mm			ID	ID	ID	ID
2	56	2.18	45	9.5		2.8	2.1	3	1.75	● 102799	● 102885	● 102998	● 111067
3	48	2.51	45	9.5		2.8	2.1	3	2	* 102800	* 102886	* 102999	* 111068
4	40	2.84	48	11	18	3.15	2.5	3	2.25	● 102802	● 102888	● 103001	● 111070
5	40	3.17	48	11	18	3.15	2.5	3	2.55			● 103002	
6	32	3.5	50	13	20	3.55	2.8	3	2.75	● 102805	● 102891	● 103004	● 111073
8	32	4.16	53	13	21	4.5	3.55	3	3.4	● 102806	● 102892	● 103005	● 111074
10	24	4.82	58	16	25	5	4	3	3.8	● 102797	● 102883	● 102996	● 111065
1/4	20	6.35	66	19	30	6.3	5	3	5.1	● 102796	● 102882	● 102995	● 111064
5/16	18	7.93	72	22	35	8	6.3	3	6.5	● 102804	● 102890	● 103003	● 111072
3/8	16	9.52	80	24	39	10	8	3	8	● 102801	● 102887	● 103000	● 111069



# UNC ASME B1.1

HSS

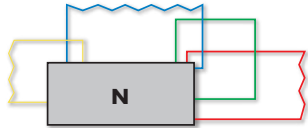
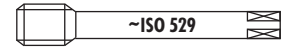

N1210-1		
N1210-2		
N1210-3		
		31 62 73 74 91
N1210-S		

N1210-1	N1210-2	N1210-3	N1210-S
---------	---------	---------	---------



		< 1.5 x D	< 2.5 x D

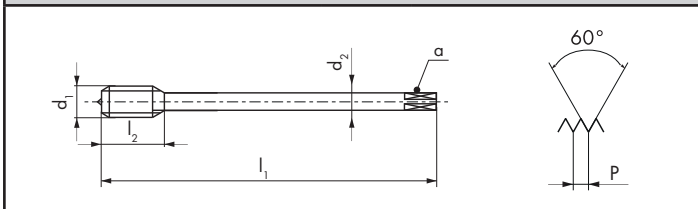

5 x P	3 x P	2 x P	
		2B	2B

Ø" d <sub>1</sub> UNC	P TPI	d <sub>1</sub> mm	l <sub>1</sub> mm	l <sub>2</sub> mm	d <sub>2</sub> mm	a mm		
7/16	14	11.11	85	22	8	6.3	3	9.3
1/2	13	12.7	89	24	9	7.1	3	10.8
5/8	11	15.87	102	32	12.5	10	3	13.6
3/4	10	19.05	112	33	14	11.2	3	16.6
1	8	25.4	130	45	18	14	4	22.3

ID	ID	ID	ID
● 103392	● 103466	● 103606	● 111236
● 103387	● 103461	● 103601	● 111229
● 103391	● 103465	● 103605	● 111235
● 103390	● 103464	● 103604	● 111234
● 103388	● 103462	● 103602	● 111230

UNC, UNC(I)











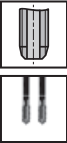

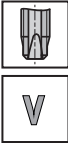

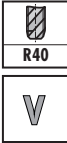
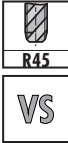

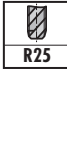







# UNF, UNEF UNS, UN

## Inhaltsverzeichnis — Maschinengewindebohrer ASME B1.1 Directory — Machine taps ASME B1.1

		N						
<b>Merkmale</b> Characteristics								
				V	TiN		V	TiN
					NEW			NEW
<b>Lochart</b> Hole type								
		<b>N310-3</b>	<b>N320-3</b> <b>N320-4</b>	<b>N320V-4</b>	<b>N320TN-4</b>	<b>N360-3</b>	<b>N360V-3</b>	<b>N360TN-3</b>
<b>DIN lang</b> DIN long	DIN 371	176	176	176	176	178	178	178
<b>ISO kurz</b> ISO short	ISO 529							
<b>Toleranz</b> Tolerance	UNF 2B	176	176	176	176	178	178	178
<b>Toleranz</b> Tolerance	UNF(J) 3B		176			178		
<b>Toleranz</b> Tolerance	UNEF 2B							
<b>Toleranz</b> Tolerance	UNS 2B							
<b>Toleranz</b> Tolerance	UN 2B							
		<b>N410-3</b>	<b>N420-4</b>	<b>N420V-4</b>	<b>N420TN-4</b>	<b>N460-3</b>	<b>N460V-3</b>	<b>N460TN-3</b>
<b>DIN lang</b> DIN long	DIN 374/~DIN 376	177 / 199	177	177	177	179 / 199	179 / 199	179
<b>ISO kurz</b> ISO short	ISO 529							
<b>Toleranz</b> Tolerance	UNF 2B	177	177	177	177	179	179	179
<b>Toleranz</b> Tolerance	UNF(J) 3B		177			179		
<b>Toleranz</b> Tolerance	UNEF 2B							
<b>Toleranz</b> Tolerance	UNS 2B	199				199	199	
<b>Toleranz</b> Tolerance	UN 2B					199	199	



















# UNF, UNEF

## Inhaltsverzeichnis — Maschinen- und Handgewindebohrer ASME B1.1 Directory — Machine and hand taps ASME B1.1

N		Z				H		
		 V	 VS	 R40 V	 R45 VS		 TiCN	 R25
			 <b>NEW</b>				 <b>NEW</b>	
								
<b>N1110 -1 -3 -S</b>	<b>N1120-4</b>	<b>Z320V-4</b>	<b>Z320VS-4</b>	<b>Z360V-3</b>	<b>Z370VS-3</b>	<b>H320-4</b>	<b>H320TC-4</b>	<b>H350-3</b>
196 / 198	198	180	180	181	182	184	184	185
196		180	180	181	182	184	184	185
198	198				182			
<b>N1210 -1 -3 -S</b>	<b>N1220-4</b>	<b>Z420V-4</b>	<b>Z420VS-4</b>	<b>Z460V-3</b>	<b>Z470VS-3</b>	<b>H420-4</b>	<b>H420TC-4</b>	<b>H450-3</b>
197 / 198	198	180	180	181	182	184	184	185
197		180	180	181	182	184	184	185
198	198							

UNF, UNF( ), UNEF,  
UN, UNS

		H	S		SA		TL	
<b>Merkmale</b> Characteristics		 R25  TTCN	 VS	 R35  VS		 R15	 R10  VS	
		 <b>NEW</b>						
<b>Lochart</b> Hole type								
		<b>H350TC-3</b>	<b>S320VS-4</b>	<b>S360VS-3</b>	<b>SA320-4</b>	<b>SA350-3</b>	<b>SA390-3</b>	<b>TL351VS-3</b>
<i>DIN lang</i> DIN long	DIN 371	185	186	186	188	188	190	188
<i>ISO kurz</i> ISO short	ISO 529							
<i>Toleranz</i> Tolerance	UNF 2B	185			188	188		188
<i>Toleranz</i> Tolerance	UNF(J) 3B		186	186	188	188	190	188
<i>Toleranz</i> Tolerance	UNEF 2B							
<i>Toleranz</i> Tolerance	UNS 2B							
<i>Toleranz</i> Tolerance	UN 2B							
		<b>H450TC-3</b>	<b>S420VS-4</b>	<b>S460VS-3</b>	<b>SA420-4</b>	<b>SA450-3</b>		<b>TL451VS-3</b>
<i>DIN lang</i> DIN long	DIN 374/~DIN 376	185	186	186	189	189		189
<i>ISO kurz</i> ISO short	ISO 529							
<i>Toleranz</i> Tolerance	UNF 2B	185			189	189		
<i>Toleranz</i> Tolerance	UNF(J) 3B		186	186	189	189		189
<i>Toleranz</i> Tolerance	UNEF 2B							
<i>Toleranz</i> Tolerance	UNS 2B							
<i>Toleranz</i> Tolerance	UN 2B							

QTAP				RTS	
					
VS	VS	VS	VS	VS	VS
					
<b>NEW</b>	<b>NEW</b>	<b>NEW</b>	<b>NEW</b>		
					
<b>Q320VS-4</b>	<b>Q323VS-4</b>	<b>Q360VS-3</b>	<b>Q363VS-3</b>	<b>RTS320VS-4</b>	<b>RTS362VS-3</b>
192	192	193	193	194	194
192	192	193	193	194	194
<b>Q420VS-4</b>	<b>Q423VS-4</b>	<b>Q460VS-3</b>	<b>Q463VS-3</b>	<b>RTS420VS-4</b>	<b>RTS462VS-3</b>
192	192	193	193	194	194
192	192	193	193	194	194

# UNF ASME B1.1

≤ Ø 2.8 > Ø 2.8

PM HSSE

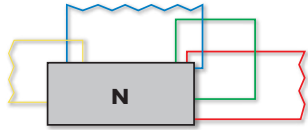
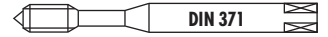

N310-3		31 62 73 74 91
N320-4		62 63 64 72 73 74 81 91
N320V-4		11 12 31 32
N320TN-4		11 12 13 14 32

N310-3	N320-4	N320V-4	N320TN-4
< 1.5 x D			

NEW

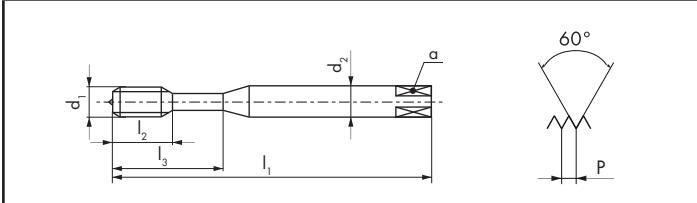

2B	2B	2B	2B

Ø" d <sub>1</sub> UNF	P TPI	d <sub>1</sub> mm	l <sub>1</sub> mm	l <sub>2</sub> mm	l <sub>3</sub> mm	d <sub>2</sub> mm	a mm		
* 0	80	1.52	40	7		2.5	2.1	2	1.2
* 2	64	2.18	45	9		2.8	2.1	2	1.8
4	48	2.84	56	12	18	3.5	2.7	3	2.35
5	44	3.17	56	12	18	3.5	2.7	3	2.6
6	40	3.5	56	13	20	4	3	3	2.9
8	36	4.16	63	14	21	4.5	3.4	3	3.5
10	32	4.82	70	15	25	6	4.9	3	4.05
12	28	5.48	80	17	30	6	4.9	3	4.6
1/4	28	6.35	80	17	30	7	5.5	3	5.5

ID	ID	ID	ID
	● 101475		
	● 101477		
	● 128847		
	● 142764		
	● 101519	● 142765	
	● 101520		
	● 101517	● 142766	● 196014
	● 101518		
● 101453	● 101516	● 142767	● 158791

--	--	--	--	--	--	--	--	--	--

--	--	--	--

--	--	--	--	--	--	--	--	--	--

<b>3B</b> UNF(J)
---------------------

Ø" d <sub>1</sub> UNF	P TPI	d <sub>1</sub> mm	l <sub>1</sub> mm	l <sub>2</sub> mm	l <sub>3</sub> mm	d <sub>2</sub> mm	a mm		
10	32	4.82	70	15	25	6	4.9	3	4.15
1/4	28	6.35	80	17	30	7	5.5	3	5.55

ID
● 135506
● 155323

\* N320-3

# UNF ASME B1.1

HSSE

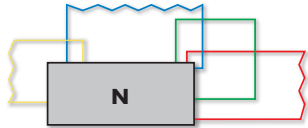

<b>N410-3</b>		31 62 73 74 91
<b>N420-4</b>		62 63 64 72 73 74 81 91
<b>N420V-4</b>	<b>V</b>	11 12 31 32
<b>N420TN-4</b>	<b>TiN</b>	11 12 13 14 32

N410-3	N420-4	N420V-4	N420TN-4
			<b>NEW</b>
< 1.5 x D			

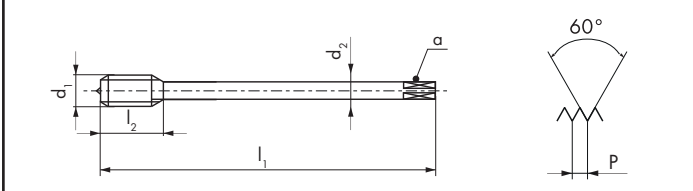

2.5 x P	4 x P	4 x P	4 x P
<b>2B</b>	<b>2B</b>	<b>2B</b>	<b>2B</b>

Ø" d <sub>1</sub> UNF	P TPI	d <sub>1</sub> mm	l <sub>1</sub> mm	l <sub>2</sub> mm	d <sub>2</sub> mm	a mm		
5/16	24	7.93	90	20	6	4.9	3	6.9
3/8	24	9.52	100	22	7	5.5	3	8.5
7/16	20	11.11	100	19	8	6.2	3	9.8
1/2	20	12.7	100	24	9	7	3	11.4
9/16	18	14.28	100	24	11	9	3	12.9
5/8	18	15.87	100	26	12	9	3	14.5
3/4	16	19.05	125	33	14	11	4	17.5
7/8	14	22.22	140	36	18	14.5	4	20.4
1	12	25.4	160	39	18	14.5	4	23.3
1 1/8	12	28.57	180	39	22	18	4	26.5
1 1/4	12	31.75	180	39	22	18	4	29.7
1 3/8	12	34.92	200	36	28	22	4	32.8
1 1/2	12	38.1	200	41	32	24	4	36

ID	ID	ID	ID
● 102004	● 102223	● 142774	● 196015
● 102003	● 102222	● 142775	● 196016
● 102006	● 102225	● 142776	● 196017
● 102000	● 102219	● 142777	● 196018
	● 102227		
● 102005	● 102224	● 142778	● 196019
● 102002	● 102221	● 142779	● 185919
	● 102226		
	● 102220	● 142780	
	● 142773		
	● 102218		
	● 105137		
	● 105138		

									<b>3B UNF(J)</b>
--	--	--	--	--	--	--	--	--	------------------









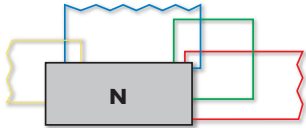

Ø" d <sub>1</sub> UNF	P TPI	d <sub>1</sub> mm	l <sub>1</sub> mm	l <sub>2</sub> mm	d <sub>2</sub> mm	a mm		
5/16	24	7.93	90	20	6	4.9	3	7
3/8	24	9.52	100	22	7	5.5	3	8.6
7/16	20	11.11	100	19	8	6.2	3	10
1/2	20	12.7	100	24	9	7	3	11.55





ID
● 155328
● 155326
● 155330
● 155321



UNF, UNF(J)

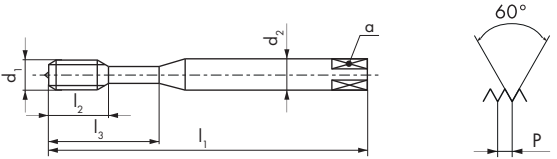





	N360-3	N360V-3	N360TN-3
<b>N360-3</b>	 <b>R40</b>	<b>63</b> <b>72</b> <b>73</b> <b>74</b> <b>81</b> <b>91</b>	
<b>N360V-3</b>	 <b>R40</b>  <b>V</b>	<b>11</b> <b>12</b> <b>32</b>	
<b>N360TN-3</b>	 <b>R40</b>  <b>TiN</b>	<b>11</b> <b>12</b> <b>13</b> <b>14</b> <b>32</b>	 <b>NEW</b>
			

			
	<b>2B</b>	<b>2B</b>	<b>2B</b>

$\emptyset'' d_1$ UNF	P TPI	$d_1$ mm	$l_1$ mm	$l_2$ mm	$l_3$ mm	$d_2$ mm	a mm			ID	ID	ID
6	40	3.5	56	6.5	20	4	3	3	2.9	● 101686		
10	32	4.82	70	9	25	6	4.9	3	4.05	● 101682	● 101730	● 196009
12	28	5.48	80	11	30	6	4.9	3	4.6	● 101683		
1/4	28	6.35	80	11	30	7	5.5	3	5.5	● 101681	● 101729	● 146137
5/16	24	7.93	90	12.5	35	8	6.2	3	6.9	● 101685	● 101732	● 196010
3/8	24	9.52	100	14	39	10	8	3	8.5	● 101684	● 101731	● 196011

										<b>3B</b> UNF(J)		
--	--	--	--	--	--	--	--	--	--	---------------------	--	--

$\emptyset'' d_1$ UNF	P TPI	$d_1$ mm	$l_1$ mm	$l_2$ mm	$l_3$ mm	$d_2$ mm	a mm			ID
10	32	4.82	70	9	25	6	4.9	3	4.15	● 155325
1/4	28	6.35	80	11	30	7	5.5	3	5.55	● 155324
5/16	24	7.93	90	12.5	35	8	6.2	3	7	● 155329
3/8	24	9.52	100	14	39	10	8	3	8.6	● 155327

# UNF ASME B1.1

HSSE

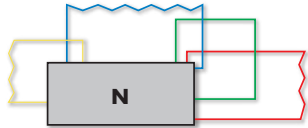

<b>N460-3</b>		63 72 73 74 81 91
<b>N460V-3</b>		11 12 32
<b>N460TN-3</b>		11 12 13 14 32

N460-3	N460V-3	N460TN-3	
--------	---------	----------	--



--	--	--

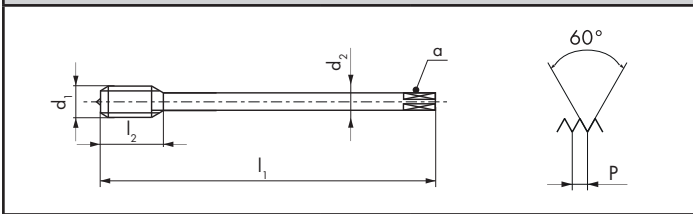

<b>2B</b>	<b>2B</b>	<b>2B</b>

Ø" d <sub>1</sub> UNF	P TPI	d <sub>1</sub> mm	l <sub>1</sub> mm	l <sub>2</sub> mm	d <sub>2</sub> mm	a mm		
7/16	20	11.11	100	14	8	6.2	3	9.8
1/2	20	12.7	100	14	9	7	3	11.4
9/16	18	14.28	100	14	11	9	3	12.9
5/8	18	15.87	100	14	12	9	3	14.5
3/4	16	19.05	125	18	14	11	4	17.5
7/8	14	22.22	140	20	18	14.5	4	20.4
1	12	25.4	160	27	18	14.5	4	23.3
1 1/8	12	28.57	180	24	22	18	4	26.5
1 1/4	12	31.75	180	24	22	18	4	29.7
1 1/2	12	38.1	200	30	32	24	5	36

ID	ID	ID
● 102434	● 142781	● 158885
● 102430	● 102503	● 196012
● 102436	● 143422	
● 102433	● 143097	● 196013
● 102432	● 102505	● 142568
● 102435	● 144714	
● 102431	● 102504	
● 102429	● 144414	
● 102428	● 151709	
● 102427	● 148793	

<b>3B UNF(J)</b>
------------------

Ø" d <sub>1</sub> UNF	P TPI	d <sub>1</sub> mm	l <sub>1</sub> mm	l <sub>2</sub> mm	d <sub>2</sub> mm	a mm		
7/16	20	11.11	100	14	8	6.2	3	10
1/2	20	12.7	100	14	9	7	3	11.55

ID
● 155331
● 155322

UNF, UNF(J)

# UNF ASME B1.1

PM

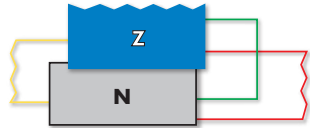
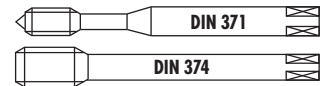

Z320V-4		V	11 12 13 21 32
Z420V-4		V	11 12 13 21 32
Z320VS-4		VS	11 12 13 14 21 22 23 32 61 63 94
Z420VS-4		VS	11 12 13 14 21 22 23 32 61 63 94

Z320V-4	Z420V-4	Z320VS-4	Z420VS-4
---------	---------	----------	----------

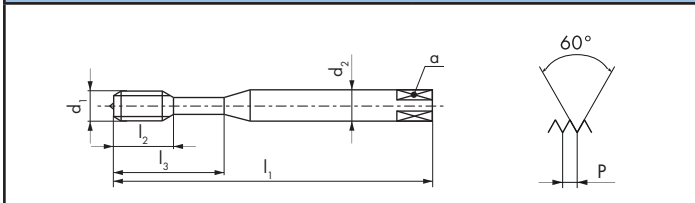
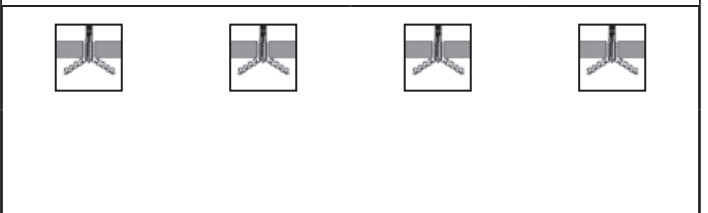
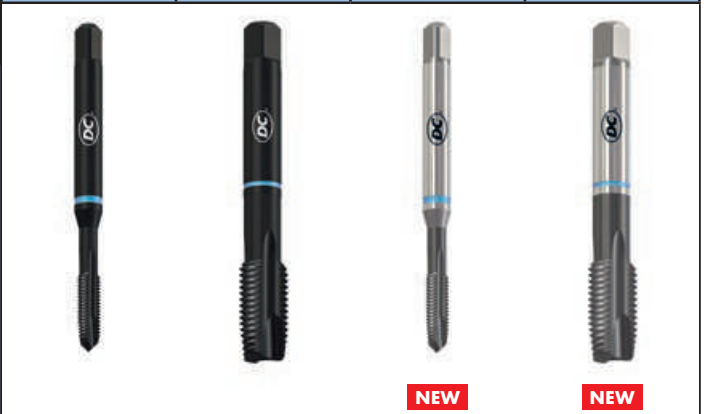

2B	2B	2B	2B

Ø" d <sub>1</sub> UNF	P TPI	d <sub>1</sub> mm	l <sub>1</sub> mm	l <sub>2</sub> mm	l <sub>3</sub> mm	d <sub>2</sub> mm	a mm			ID	ID	ID	ID
10	32	4.82	70	15	25	6	4.9	3		● 142783		● 128685	
1/4	28	6.35	80	17	30	7	5.5	3		● 142784		● 128596	
5/16	24	7.93	90	20	35	8	6.2	3		● 142785		● 128869	
3/8	24	9.52	100	22	39	10	8	3		● 142786		● 128814	
7/16	20	11.11	100	19		8	6.2	3			● 142787		● 128960
1/2	20	12.7	100	24		9	7	3			● 142788		● 128556
5/8	18	15.87	100	26		12	9	3					● 196031
3/4	16	19.05	125	33		14	11	4					● 196032

# UNF ASME B1.1

HSSE

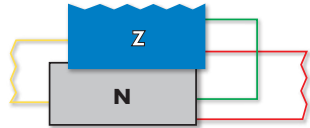
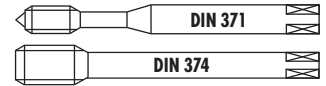

Z360V-3



12 21 32

Z460V-3



12 21 32

Z360V-3

Z460V-3

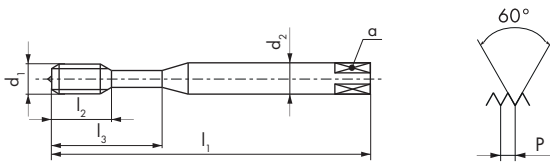

2B

2B

Ø" d <sub>1</sub> UNF	P TPI	d <sub>1</sub> mm	l <sub>1</sub> mm	l <sub>2</sub> mm	l <sub>3</sub> mm	d <sub>2</sub> mm	a mm		
10	32	4.82	70	9	25	6	4.9	3	4.05
1/4	28	6.35	80	11	30	7	5.5	3	5.5
5/16	24	7.93	90	12.5	35	8	6.2	3	6.9
3/8	24	9.52	100	14	39	10	8	3	8.5
7/16	20	11.11	100	14		8	6.2	3	9.8
1/2	20	12.7	100	14		9	7	3	11.4
5/8	18	15.87	100	14		12	9	3	14.5
3/4	16	19.05	125	18		14	11	4	17.5

ID

ID

● 104680

● 104679

● 104682

● 104681

● 104741

● 104738

● 104740

● 104739

UNF, UNF(1)

# UNF ASME B1.1

PM

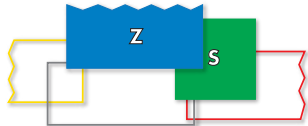
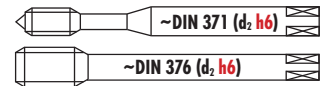

Z370VS-3		VS		14 15 21 22 23 24 51 61 94
Z470VS-3		VS		
Z370VS-3		VS		13 14 15 21 22 23 24 51 52
Z470VS-3		VS		

Z370VS-3	Z470VS-3
< 3 x D	< 3 x D

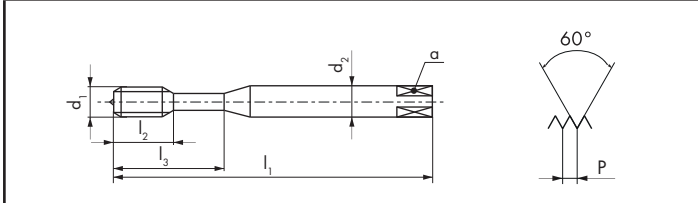

2BX	2BX

Ø" d <sub>1</sub> UNF	P TPI	d <sub>1</sub> mm	l <sub>1</sub> mm	l <sub>2</sub> mm	l <sub>3</sub> mm	d <sub>2</sub> h <sub>6</sub> mm	a mm		
10	32	4.82	70	9	25	6	4.9	3	4.05
1/4	28	6.35	80	11	30	* 6	* 4.9	3	5.5
5/16	24	7.93	90	12.5	35	8	6.2	3	6.9
3/8	24	9.52	100	14	39	10	8	3	8.5
7/16	20	11.11	100	14		8	6.2	3	9.8
1/2	20	12.7	110	14		* 10	* 8	4	11.4
5/8	18	15.87	110	18		12	9	4	14.5
3/4	16	19.05	125	21		14	11	4	17.5

\* Norme DC / \* DC Norm/ \* Norma DC

ID	ID
● 166136	
● 166135	
● 166134	
● 166133	
	● 166138
	● 166137
	● 196029
	● 196030

--

--

Ø" d <sub>1</sub> UNF	P TPI	d <sub>1</sub> mm	l <sub>1</sub> mm	l <sub>2</sub> mm	l <sub>3</sub> mm	d <sub>2</sub> h <sub>6</sub> mm	a mm		
10	32	4.82	70	9	25	6	4.9	3	4.15
1/4	28	6.35	80	11	30	* 6	* 4.9	3	5.55
5/16	24	7.93	90	12.5	35	8	6.2	3	7
3/8	24	9.52	100	14	39	10	8	3	8.6

\* Norme DC / \* DC Norm/ \* Norma DC

ID
● 165121
● 165122
● 165123
● 165124

# MJ, UNJC, UNJF

*Unsere Maschinen-Gewindebohrer mit Radius auf dem Aussendurchmesser zusammengefasst in einem separaten Kapitel ab Seite 44.*



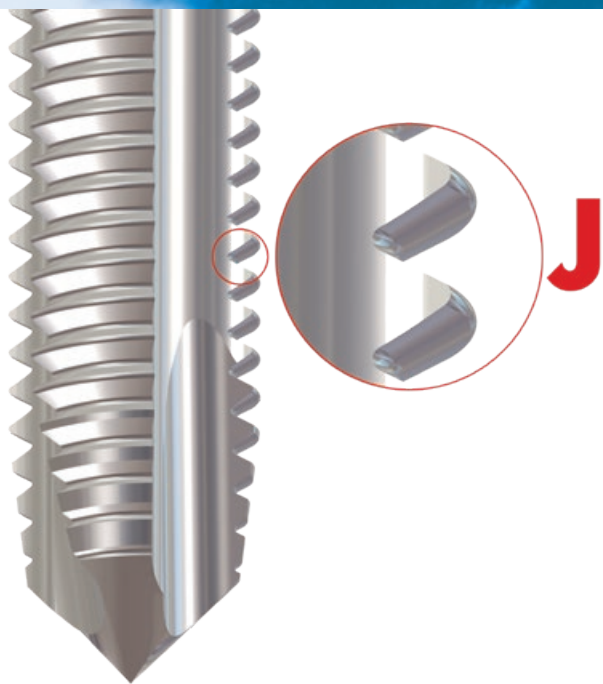





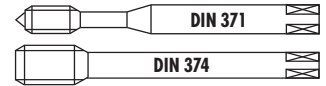



**Our machine taps with radius on the outside diameter summarised in a separate chapter from page 44.**

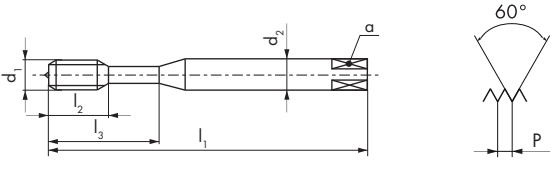

# UNF ASME B1.1

PM



										H320-4	H420-4	H320TC-4	H420TC-4
													
H320-4		15 16 62 64 82											
H420-4		15 16 62 64 82											
H320TC-4	 TiCN	15 16 24 31 82 83 92 93								NEW			
H420TC-4	 TiCN	15 16 24 31 82 83 92 93								NEW			
										 <b>2B</b>	 <b>2B</b>	 <b>2B</b>	 <b>2B</b>
Ø" d <sub>1</sub> UNF	P TPI	d <sub>1</sub> mm	l <sub>1</sub> mm	l <sub>2</sub> mm	l <sub>3</sub> mm	d <sub>2</sub> mm	a mm			ID	ID	ID	ID
10	32	4.82	70	15	25	6	4.9	3	4.05	● 101228		● 196060	
1/4	28	6.35	80	17	30	7	5.5	3	5.5	● 101227		● 142613	
5/16	24	7.93	90	20	35	8	6.2	3	6.9	● 105139		● 196061	
3/8	24	9.52	100	22	39	10	8	3	8.5	● 101229		● 196062	
7/16	20	11.11	100	19		8	6.2	3	9.8		● 147253		● 196063
1/2	20	12.7	100	24		9	7	4	11.4		● 101291		● 196064
5/8	18	15.87	100	26		12	9	4	14.5		● 101293		● 196065
3/4	16	19.05	125	33		14	11	4	17.5		● 101292		● 196066



# UNF ASME B1.1

PM

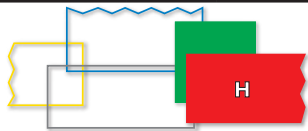
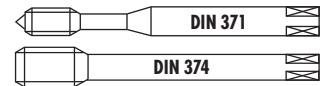

										H350-3	H450-3	H350TC-3	H450TC-3
<p><b>H350-3</b> <b>15 16 62 64 82</b></p> <p><b>H450-3</b> <b>15 16 62 64 82</b></p> <p><b>H350TC-3</b> <b>15 16 24 31 82 83</b> <b>92 93</b></p> <p><b>H450TC-3</b> <b>15 16 24 31 82 83</b> <b>92 93</b></p>													
$\emptyset$ " d <sub>1</sub> UNF	P TPI	d <sub>1</sub> mm	l <sub>1</sub> mm	l <sub>2</sub> mm	l <sub>3</sub> mm	d <sub>2</sub> mm	a mm			ID	ID	ID	ID
10	32	4.82	70	9	25	6	4.9	3		● 101265		● 196055	
1/4	28	6.35	80	11	30	7	5.5	3		● 101264		● 146714	
5/16	24	7.93	90	12.5	35	8	6.2	3		● 101267		● 196056	
3/8	24	9.52	100	14	39	10	8	3		● 101266		● 196057	
7/16	20	11.11	100	14		8	6.2	3			● 101334		● 196058
1/2	20	12.7	100	14		9	7	4			● 101331		● 196059
5/8	18	15.87	100	14		12	9	4			● 101333		● 174297
3/4	16	19.05	125	18		14	11	4			● 101332		● 158882

UNF, UNF(1)

# UNF ASME B1.1

PM

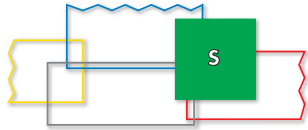
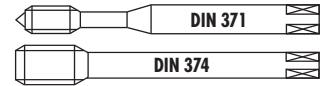

<b>S320VS-4</b>		<b>VS</b>	13 15 16 22 23 24 52
<b>S420VS-4</b>		<b>VS</b>	13 15 16 22 23 24 52
<b>S360VS-3</b>		<b>VS</b>	R35 13 15 16 22 23 24 52
<b>S460VS-3</b>		<b>VS</b>	R35 13 15 16 22 23 24 52

S320VS-4	S420VS-4	S360VS-3	S460VS-3
----------	----------	----------	----------



		< 2 x D	< 2 x D

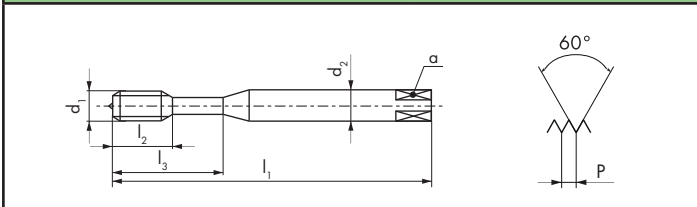

4 x P	4 x P	2.5 x P	2.5 x P
<b>3B UNF(J)</b>	<b>3B UNF(J)</b>		

$\emptyset$ " d <sub>1</sub> UNF	P TPI	d <sub>1</sub> mm	l <sub>1</sub> mm	l <sub>2</sub> mm	l <sub>3</sub> mm	d <sub>2</sub> mm	a mm			ID	ID
10	32	4.82	70	15	25	6	4.9	3	4.15	● 111814	
1/4	28	6.35	80	17	30	7	5.5	3	5.55	● 111813	
5/16	24	7.93	90	20	35	8	6.2	3	7	● 111816	
3/8	24	9.52	100	22	39	10	8	3	8.6	● 111818	
7/16	20	11.11	100	22		8	6.2	3	10		● 111837

										<b>3B UNF(J)</b>	<b>3B UNF(J)</b>
--	--	--	--	--	--	--	--	--	--	------------------	------------------

$\emptyset$ " d <sub>1</sub> UNF	P TPI	d <sub>1</sub> mm	l <sub>1</sub> mm	l <sub>2</sub> mm	l <sub>3</sub> mm	d <sub>2</sub> mm	a mm			ID	ID
10	32	4.82	70	9	25	6	4.9	3	4.15	● 111815	
1/4	28	6.35	80	11	30	7	5.5	3	5.55	● 111820	
5/16	24	7.93	90	12.5	35	8	6.2	3	7	● 111817	
3/8	24	9.52	100	14	39	10	8	3	8.6	● 111819	
7/16	20	11.11	100	14		8	6.2	3	10		● 111833



**S** | **RESPECTING  
THREADING**

UNE UNF( )



## aero

SA320-4



15 16 52 64

SA350-3



15 16 52 64

TL351VS-3



41 42

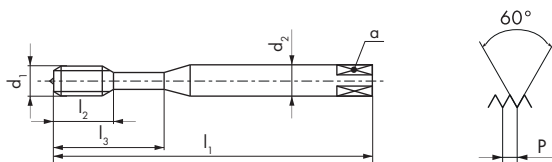

SA320-4

SA350-3

TL351VS-3



< 1.5 x D

< 2 x D



< 2 x D



4 x P

2.5 x P

2.5 x P

2B

2B

2B

Ø" d <sub>1</sub> UNF	P TPI	d <sub>1</sub> mm	l <sub>1</sub> mm	l <sub>2</sub> mm	l <sub>3</sub> mm	d <sub>2</sub> mm	a mm		
10	32	4.82	70	15		6	4.9	3	4.05
1/4	28	6.35	80	15	23	7	5.5	3	5.5
5/16	24	7.93	90	18	29	8	6.2	3	6.9
3/8	24	9.52	100	20	33	10	8	3	8.5

ID

ID

ID

● 149133	● 149135	● 152047
● 149230	● 149232	● 152066
● 149277	● 149279	● 152072
● 149339	● 149341	● 152083

3B  
UNF(J)

3B  
UNF(J)

3B  
UNF(J)

Ø" d <sub>1</sub> UNF	P TPI	d <sub>1</sub> mm	l <sub>1</sub> mm	l <sub>2</sub> mm	l <sub>3</sub> mm	d <sub>2</sub> mm	a mm		
4	48	2.84	56	12		3.5	2.7	3	2.35
10	32	4.82	70	15		6	4.9	3	4.15
1/4	28	6.35	80	15	23	7	5.5	3	5.55
5/16	24	7.93	90	18	29	8	6.2	3	7
3/8	24	9.52	100	20	33	10	8	3	8.6

ID

ID

ID





















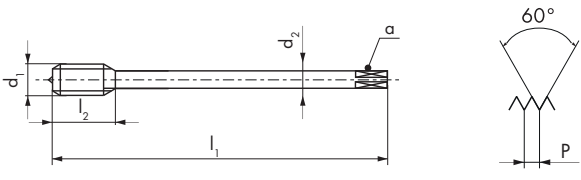











	● 149015	
● 146098	● 149138	● 148004
● 146404	● 149235	● 148012
● 146393	● 149282	● 148016
● 147165	● 149344	● 148023

# UNF ASME B1.1

PM



## aero

										SA420-4	SA450-3		TL451VS-3																																																														
<p>SA420-4  <span style="background-color: #90EE90; padding: 2px;">15</span> <span style="background-color: #FF4500; padding: 2px;">16</span> <span style="background-color: #90EE90; padding: 2px;">52</span> <span style="background-color: #90EE90; padding: 2px;">64</span></p> <p>SA450-3  R15 <span style="background-color: #90EE90; padding: 2px;">15</span> <span style="background-color: #FF4500; padding: 2px;">16</span> <span style="background-color: #90EE90; padding: 2px;">52</span> <span style="background-color: #90EE90; padding: 2px;">64</span></p>																																																																											
<p>TL451VS-3  R15  VS <span style="background-color: #0000FF; color: white; padding: 2px;">41</span> <span style="background-color: #0000FF; color: white; padding: 2px;">42</span></p>														 < 1.5 x D	 < 2 x D	 < 2 x D																																																											
										 4 x P	 2.5 x P		 2.5 x P																																																														
										 2B	 2B																																																																
<table border="1"> <thead> <tr> <th>Ø" d<sub>1</sub> UNF</th> <th>P TPI</th> <th>d<sub>1</sub> mm</th> <th>l<sub>1</sub> mm</th> <th>l<sub>2</sub> mm</th> <th>d<sub>2</sub> mm</th> <th>a mm</th> <th></th> <th></th> <th>ID</th> <th>ID</th> <th>ID</th> </tr> </thead> <tbody> <tr> <td>7/16</td> <td>20</td> <td>11.11</td> <td>100</td> <td>22</td> <td>8</td> <td>6.2</td> <td>* 4</td> <td>9.8</td> <td>● 152286</td> <td>● 152290</td> <td></td> </tr> <tr> <td>1/2</td> <td>20</td> <td>12.7</td> <td>100</td> <td>24</td> <td>9</td> <td>7</td> <td>4</td> <td>11.4</td> <td>● 152287</td> <td>● 152291</td> <td></td> </tr> <tr> <td>5/8</td> <td>18</td> <td>15.87</td> <td>100</td> <td>26</td> <td>12</td> <td>9</td> <td>4</td> <td>14.5</td> <td>★ 152289</td> <td></td> <td></td> </tr> </tbody> </table>										Ø" d <sub>1</sub> UNF	P TPI	d <sub>1</sub> mm	l <sub>1</sub> mm	l <sub>2</sub> mm	d <sub>2</sub> mm	a mm			ID	ID	ID	7/16	20	11.11	100	22	8	6.2	* 4	9.8	● 152286	● 152290		1/2	20	12.7	100	24	9	7	4	11.4	● 152287	● 152291		5/8	18	15.87	100	26	12	9	4	14.5	★ 152289																				
Ø" d <sub>1</sub> UNF	P TPI	d <sub>1</sub> mm	l <sub>1</sub> mm	l <sub>2</sub> mm	d <sub>2</sub> mm	a mm			ID	ID	ID																																																																
7/16	20	11.11	100	22	8	6.2	* 4	9.8	● 152286	● 152290																																																																	
1/2	20	12.7	100	24	9	7	4	11.4	● 152287	● 152291																																																																	
5/8	18	15.87	100	26	12	9	4	14.5	★ 152289																																																																		
										 3B UNF(J)	 3B UNF(J)		 3B UNF(J)																																																														
<table border="1"> <thead> <tr> <th>Ø" d<sub>1</sub> UNF</th> <th>P TPI</th> <th>d<sub>1</sub> mm</th> <th>l<sub>1</sub> mm</th> <th>l<sub>2</sub> mm</th> <th>d<sub>2</sub> mm</th> <th>a mm</th> <th></th> <th></th> <th>ID</th> <th>ID</th> <th>ID</th> </tr> </thead> <tbody> <tr> <td>7/16</td> <td>20</td> <td>11.11</td> <td>100</td> <td>22</td> <td>8</td> <td>6.2</td> <td>* 4</td> <td>10</td> <td>● 147187</td> <td>● 152302</td> <td>● 148031</td> </tr> <tr> <td>1/2</td> <td>20</td> <td>12.7</td> <td>100</td> <td>24</td> <td>9</td> <td>7</td> <td>4</td> <td>11.55</td> <td>● 147189</td> <td>● 152303</td> <td>● 152310</td> </tr> <tr> <td>9/16</td> <td>18</td> <td>14.28</td> <td>100</td> <td>24</td> <td>11</td> <td>9</td> <td>4</td> <td>13.05</td> <td>● 146395</td> <td></td> <td></td> </tr> <tr> <td>5/8</td> <td>18</td> <td>15.87</td> <td>100</td> <td>26</td> <td>12</td> <td>9</td> <td>4</td> <td>14.6</td> <td>● 147169</td> <td></td> <td></td> </tr> </tbody> </table>										Ø" d <sub>1</sub> UNF	P TPI	d <sub>1</sub> mm	l <sub>1</sub> mm	l <sub>2</sub> mm	d <sub>2</sub> mm	a mm			ID	ID	ID	7/16	20	11.11	100	22	8	6.2	* 4	10	● 147187	● 152302	● 148031	1/2	20	12.7	100	24	9	7	4	11.55	● 147189	● 152303	● 152310	9/16	18	14.28	100	24	11	9	4	13.05	● 146395			5/8	18	15.87	100	26	12	9	4	14.6	● 147169								
Ø" d <sub>1</sub> UNF	P TPI	d <sub>1</sub> mm	l <sub>1</sub> mm	l <sub>2</sub> mm	d <sub>2</sub> mm	a mm			ID	ID	ID																																																																
7/16	20	11.11	100	22	8	6.2	* 4	10	● 147187	● 152302	● 148031																																																																
1/2	20	12.7	100	24	9	7	4	11.55	● 147189	● 152303	● 152310																																																																
9/16	18	14.28	100	24	11	9	4	13.05	● 146395																																																																		
5/8	18	15.87	100	26	12	9	4	14.6	● 147169																																																																		
<p>* SA420-4 =  3</p>																																																																											

UNF, UNF(J)

# aero

SA390-3



16 53

SA390-3

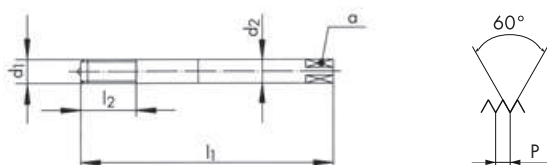

$\varnothing'' d_1$ UNF	P TPI	$d_1$ mm	$l_1$ mm	$l_2$ mm	$d_2$ mm	$a$ mm			ID
10	32	4.82	70	15	6	4.9	3	4.15	● 149687
1/4	28	6.35	80	20	7	5.5	3	5.55	● 149715
5/16	24	7.93	90	25	8	6.2	3	7	● 149728
3/8	24	9.52	100	30	10	8	3	8.6	● 149745



UNE, UNF(1)

**NEW**

**DER PERFEKTE "ALLROUNDER"**

*Lieferbar für M-, MF-, UNC-, UNF- und G-Gewinde*

**THE PERFECT "ALLROUNDER"**

*Available for M, MF, UNC, UNF and G threads*





PM

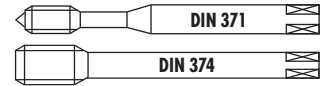

## QTAP

Q320VS-4



Q420VS-4



Q323VS-4

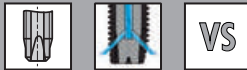

Q423VS-4

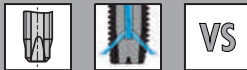

- 11 12 13 14
- 15 21 22 23
- 24 31 32 51
- 52 61 62 63
- 64 71 72 73
- 74 81 82 83
- 91 92 94

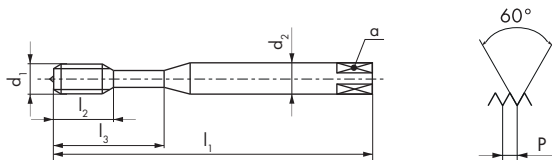

Q320VS-4

Q420VS-4

Q323VS-4

Q423VS-4



NEW



NEW



NEW



NEW



2B

2B

2B

2B

Ø" d <sub>1</sub> UNF	P TPI	d <sub>1</sub> mm	l <sub>1</sub> mm	l <sub>2</sub> mm	l <sub>3</sub> mm	d <sub>2</sub> mm	a mm		
10	32	4.82	70	15	25	6	4.9	3	4.05
1/4	28	6.35	80	17	30	7	5.5	3	5.5
5/16	24	7.93	90	20	35	8	6.2	3	6.9
3/8	24	9.52	100	22	39	10	8	3	8.5
7/16	20	11.11	100	19		8	6.2	3	9.8
1/2	20	12.7	100	24		9	7	3	11.4

ID

ID

ID

ID

● 196298

● 197631

1/4 28 6.35 80 17 30 7 5.5 3 5.5

● 196299

● 197632

5/16 24 7.93 90 20 35 8 6.2 3 6.9

● 196300

● 197633

3/8 24 9.52 100 22 39 10 8 3 8.5

● 196301

● 197634

7/16 20 11.11 100 19 8 6.2 3 9.8

● 196302

● 197635

1/2 20 12.7 100 24 9 7 3 11.4

● 196303

● 197636



≤ Ø 16 > Ø 16

PM HSSE

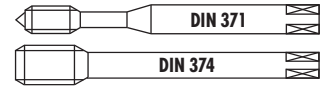

## QTAP

Q360VS-3



Q460VS-3



Q363VS-3



Q463VS-3



- 11 12 13 14
- 15 21 22 23
- 24 31 32 51
- 52 61 62 63
- 64 71 72 73
- 74 81 82 83
- 91 92 94

Q360VS-3

Q460VS-3

Q363VS-3

Q463VS-3



NEW



NEW



NEW



NEW



< 2.5 x D



< 2.5 x D



< 2.5 x D



< 2.5 x D

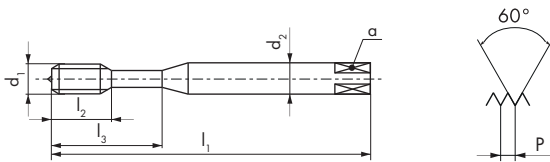

2B



2B



2B



2B

Ø" d <sub>1</sub> UNF	P TPI	d <sub>1</sub> mm	l <sub>1</sub> mm	l <sub>2</sub> mm	l <sub>3</sub> mm	d <sub>2</sub> mm	a mm		
10	32	4.82	70	9	25	6	4.9	3	4.05
1/4	28	6.35	80	11	30	7	5.5	3	5.5
5/16	24	7.93	90	12.5	35	8	6.2	3	6.9
3/8	24	9.52	100	14	39	10	8	3	8.5
7/16	20	11.11	100	14		8	6.2	3	9.8
1/2	20	12.7	100	14		9	7	3	11.4
5/8	18	15.87	100	14		12	9	3	14.5
3/4	16	19.05	125	18		14	11	4	17.5

ID

ID

ID

ID

● 196304

● 197637

● 196305

● 197638

● 196306

● 197639

● 196307

● 197640

● 196308

● 197641

● 196309

● 197642

● 196310

● 197643

● 196311

● 197644



Uniquement pour taraudage synchrone  
 Nur für Synchrobearbeitung  
 Only for rigid tapping  
 Solo per maschiatura sincrona  
 Solo para masado sincronizado  
 Тільки для рідкого tapping

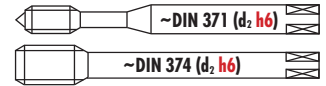

# RTS

## Rigid Tapping Synchro

RTS320VS-4



RTS420VS-4



RTS362VS-3



RTS462VS-3





RTS320VS-4

RTS420VS-4

RTS362VS-3

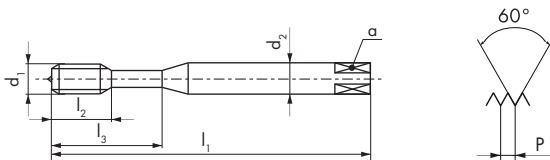
RTS462VS-3



Ø" d <sub>1</sub> UNF	P TPI	d <sub>1</sub> mm	l <sub>1</sub> mm	l <sub>2</sub> mm	l <sub>3</sub> mm	d <sub>2</sub> h <sub>6</sub> mm	a mm		
10	32	4.82	70	9	25	6	4.9	3	4.05
1/4	28	6.35	80	11	30	* 6	* 4.9	3	5.5
5/16	24	7.93	90	12.5	35	8	6.2	3	6.9
3/8	24	9.52	100	14	39	10	8	3	8.5
1/2	20	12.7	110	14		* 10	* 8	3	11.4

ID	ID	ID	ID
● 157409		● 157413	
● 157410		● 157414	
● 157411		● 157415	
● 157412		● 157416	
	● 157417		● 157418

\* Norme DC / \* DC Norm/ \* Norma DC



sur demande  
 auf Anfrage  
 on request  
 su richiesta  
 sobre pedido  
 no zapytocy



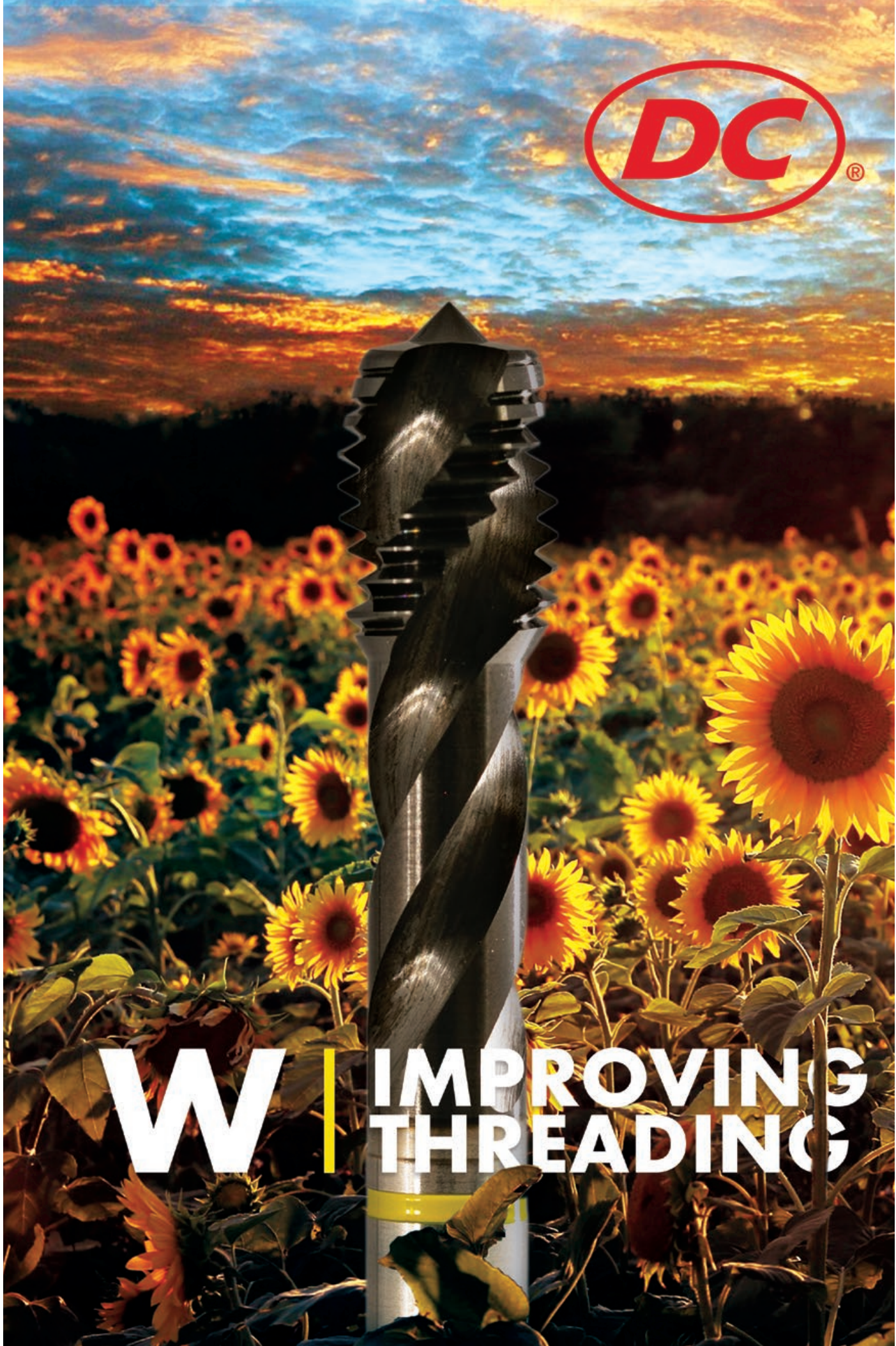

# W | IMPROVING THREADING

UNE UNF( )



# UNF ASME B1.1

≤ Ø 2.8 > Ø 2.8

PM HSS



										N1110-1	N1110-3	N1110-S
										N1110-1		
N1110-3												
N1110-S												
Ø" d <sub>1</sub> UNF	P TPI	d <sub>1</sub> mm	l <sub>1</sub> mm	l <sub>2</sub> mm	l <sub>3</sub> mm	d <sub>2</sub> mm	a mm			ID	ID	ID
0	80	1.52	40	7		2.5	2.1	3	1.2	● 102811	● 103010	● 111079
1	72	1.85	40	8		2.5	2.1	3	1.5	● 102812	● 103011	● 111080
8	36	4.16	53	13	21	4.5	3.55	3	3.5		★ 103022	
10	32	4.82	58	16	25	5	4	3	4.05	● 102814	● 103013	● 111082
12	28	5.48	62	17	26	5.6	4.5	3	4.6		★ 103014	
1/4	28	6.35	66	19	30	6.3	5	3	5.5	● 102813	● 103012	● 111081
5/16	24	7.93	72	22	35	8	6.3	3	6.9	● 102821	● 103020	● 111089
3/8	24	9.52	80	24	39	10	8	3	8.5	● 102818	● 103017	● 111086

# UNF ASME B1.1

HSS

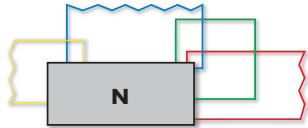
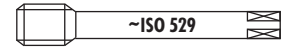

N1210-1

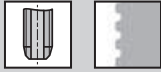

N1210-3

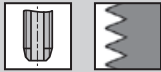

31 62 73 74 91

N1210-S



N1210-1

N1210-3

N1210-S

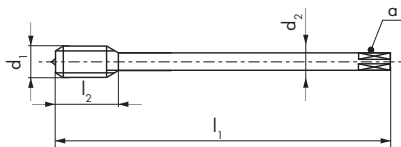

2B

2B

$\varnothing'' d_1$ UNF	P TPI	$d_1$ mm	$l_1$ mm	$l_2$ mm	$d_2$ mm	$a$ mm		
7/16	20	11.11	85	22	8	6.3	3	9.8
1/2	20	12.7	89	24	9	7.1	3	11.4
5/8	18	15.87	102	32	12.5	10	3	14.5
3/4	16	19.05	112	33	14	11.2	4	17.5
7/8	14	22.22	115	32	16	12.5	4	20.4
1	12	25.4	130	45	18	14	4	23.3

ID

ID

ID

● 103411	● 103626	● 111255
● 103407	● 103622	● 111251
● 103410	● 103625	● 111254
● 103409	● 103624	● 111253
● 103412	● 103627	● 111256
● 103408	● 103623	● 111252

UNE UNF(1)



# UNEF ASME B1.1

HSS

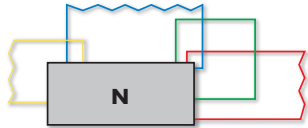
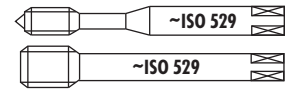

N1110-3		31 62 73 74 91
N1120-4		62 63 64 72 73 74 81 91
N1210-3		31 62 73 74 91
N1220-4		62 63 64 72 73 74 81 91

N1110-3	N1120-4	N1210-3	N1220-4
---------	---------	---------	---------



< 1.5 x D		< 1.5 x D	

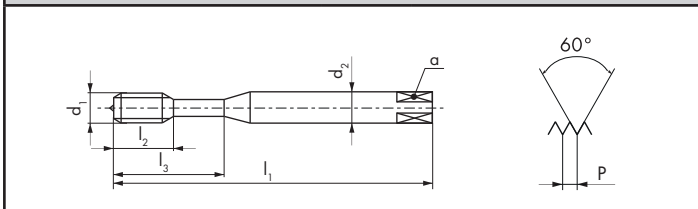

2B	2B	2B	2B









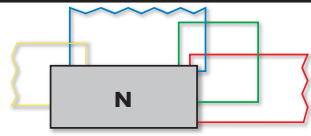



Ø" d <sub>1</sub> UNEF	P TPI	d <sub>1</sub> mm	l <sub>1</sub> mm	l <sub>2</sub> mm	l <sub>3</sub> mm	d <sub>2</sub> mm	a mm			ID	ID	ID	ID
12	32	5.48	62	17	26	5.6	4.5	3	4.7	● 103007	● 103118		
1/4	32	6.35	66	19	30	6.3	5	3	5.6	● 103006	● 103117		
5/16	32	7.93	72	22	35	8	6.3	3	7.2	● 103009	● 103120		
3/8	32	9.52	80	24	39	10	8	3	8.75	● 103008	● 103119		
7/16	28	11.11	85	22		8	6.3	3	10.25			● 103615	● 103754
1/2	28	12.7	89	24		9	7.1	3	11.85			● 103609	● 103749
9/16	24	14.28	95	24		11.2	9	3	13.2			● 103617	● 103756
5/8	24	15.87	102	32		12.5	10	3	14.8			● 103614	● 103753
11/16	24	17.46	104	26		14	11.2	4	16.4			● 103611	
3/4	20	19.05	112	33		14	11.2	4	17.8			● 103613	
7/8	20	22.22	115	32		16	12.5	4	21			● 103616	
1	20	25.4	120	30		18	14	4	24.1			● 103610	

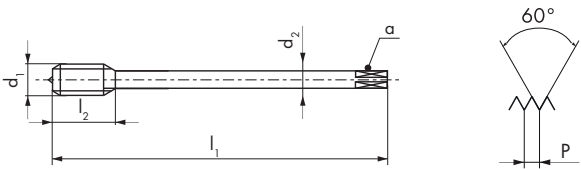

# UNS, UN ASME B1.1

HSSE

























										N410-3	N460-3	N460V-3		
<p><b>N410-3</b>  <b>31</b> <b>62</b> <b>73</b> <b>74</b> <b>91</b></p> <p><b>N460-3</b>  <b>R40</b> <b>63</b> <b>72</b> <b>73</b> <b>74</b> <b>81</b> <b>91</b></p> <p><b>N460V-3</b>  <b>R40</b>  <b>11</b> <b>12</b> <b>32</b></p>														
														
														
														
$\emptyset'' d_1$ UNS	P TPI	$d_1$ mm	$l_1$ mm	$l_2$ mm	$d_2$ mm	a mm				ID	ID	ID		
1/4	36	6.35	80	17	4.5	3.4	3	5.65	●	104899				
1/2	24	12.7	100	24	9	7	3	11.6	●	104900				
1	14	25.4	140	34	18	14.5	4	23.6	●	104898				
1	14	25.4	140	22	18	14.5	4	23.6			●	102437	●	142789
$\emptyset'' d_1$ UN	P TPI	$d_1$ mm	$l_1$ mm	$l_2$ mm	$d_2$ mm	a mm				ID	ID			
1 1/8	8	28.57	180	30	22	18	4	25.5		●	102415	●	142790	
1 1/4	8	31.75	180	30	22	18	4	28.7		●	102414	●	142520	
1 3/8	8	34.92	200	36	28	22	5	31.8		●	104896	●	142792	
1 1/2	8	38.1	200	40	32	24	5	35		●	102413	●	142793	
1 3/4	8	44.45	220	44	36	29	5	41.4				●	115198	
2	8	50.8	250	38	40	32	5	47.7				●	111622	

UNEF, UNS, UN

# G Inhaltsverzeichnis — Maschinengewindebohrer G (Rohr) DIN EN ISO 228

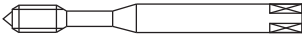























## Directory — Machine taps G (BSP) DIN EN ISO 228

	N						
<b>Merkmale</b> Characteristics		 V	 TiN	 R40	 R40 V	 R40 TiN	 R40 TiN V
							
<b>Lochart</b> Hole type							
							
	<b>N410-3</b>	<b>N420-4</b> <b>N420V-4</b>	<b>N420TN-4</b>	<b>N460-3</b>	<b>N460V-3</b>	<b>N460TN-3</b>	<b>N462V-3</b>
<b>DIN lang</b> DIN long	DIN 5156	204	205	205	206	206	206
<b>DIN lang</b> DIN long	~ DIN 376						
<b>DIN kurz</b> DIN short	DIN 5157						
<b>LH Linksgewinde</b> LH Left-hand thread	DIN 5156	204					



# G Inhaltsverzeichnis — Maschinengewindebohrer G (Rohr) DIN EN ISO 228

## Directory — Machine taps G (BSP) DIN EN ISO 228

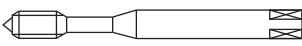
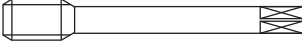
	H	GG	QTAP		RTS	
<b>Merkmale</b> Characteristics	 R25	 R15  NV	 VS	 R40  VS	 R40  VS	 R40  E 1.5xP  VS
			 	 		
			<b>NEW</b>	<b>NEW</b>	<b>NEW</b>	<b>NEW</b>
<b>Lochart</b> Hole type						
						
	<b>H450-3</b>	<b>GG450NV-3</b>	<b>Q420VS-4</b> <b>Q423VS-4</b>	<b>Q460VS-3</b> <b>Q463VS-3</b>	<b>RTS462VS-3</b>	<b>RTS462VS-5</b>
<b>DIN lang</b> DIN long	DIN 5156	207	210	211		
<b>DIN lang</b> DIN long	~ DIN 376				212	212
<b>DIN kurz</b> DIN short	DIN 5157					
<b>LH Linksgewinde</b> LH Left-hand thread	DIN 5156					

	N					
<b>Merkmale</b> <b>Characteristics</b>		 1:16	 1:16	 1:16		 HSS 1.75 x P ≥ Ø 3
<b>Lochart</b> <b>Hole type</b>						
				<b>N1110-3</b>	<b>N1120-4</b>	
<b>ISO kurz</b> <b>ISO short</b>	ISO 529			216 - 217	216	
<b>W</b>	ISO 529			216 - 217	216	
<b>SV</b>	ISO 529			217		
	<b>N420-3</b>	<b>N410-3</b>	<b>D5800</b>	<b>N1210-3</b>	<b>N1220-4</b>	<b>N5120</b>
<b>DIN lang</b> <b>DIN long</b>	DIN 5156	214				
<b>DIN lang</b> <b>DIN long</b>	DC		214	215		
<b>ISO kurz</b> <b>ISO short</b>	ISO 529			216 - 217	216	
<b>Rp</b>	DIN 5156	214				
<b>Rc</b>	DC		214	215		
<b>W</b>	ISO 529			216	216	
<b>SV</b>	ISO 529 / DC			217		217

G (ISO), Rp, Rc,  
W, SV Schaublin

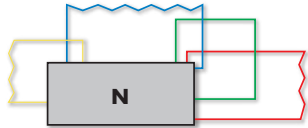

N410-3



31 / 62 / 73 / 74 / 91

N410-3 LH



LH

31 / 62 / 73 / 74 / 91

N410-3

N410-3 LH

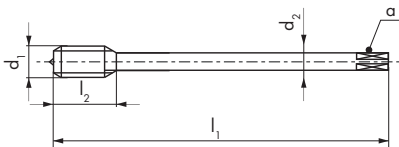

$\frac{\text{Ø}''}{G}$	$d_1$	P	$d_1$	$l_1$	$l_2$	$d_2$	a		
		TPI	mm	mm	mm	mm	mm		
1/8	28	9.72	90	22	7	5.5	3	8.75	● 101855
1/4	19	13.15	100	20	11	9	3	11.6	● 101853 ● 101854
3/8	19	16.66	100	20	12	9	4	15.2	● 101861 ● 101862
1/2	14	20.95	125	22	16	12	4	18.9	● 101851 ● 101852
3/4	14	26.44	140	28	20	16	4	24.4	● 101859
1	11	33.24	160	32	25	20	4	30.7	● 101857
1 1/4	11	41.91	170	32	32	24	5	39.3	● 101850
1 1/2	11	47.8	190	32	36	29	5	45.2	● 101849

ID

ID

# G DIN EN ISO 228 (BSP)

HSSE



										N420-4	N420V-4	N420TN-4
N420-4				62 63 64 72 73 74 81 91								
N420V-4				11 12 31 32								
N420TN-4				11 12 13 14 32								
$\frac{\text{Ø}''}{G}$ $d_1$	P TPI	$d_1$ mm	$l_1$ mm	$l_2$ mm	$d_2$ mm	a mm				ID	ID	ID
1/16	28	7.72	90	18	6	4.9	3	6.75		● 102045		
1/8	28	9.72	90	22	7	5.5	3	8.75		● 102048	● 102258	● 102236
1/4	19	13.15	100	20	11	9	3	11.6		● 102047	● 102257	● 102235
3/8	19	16.66	100	20	12	9	3	15.2		● 102053	● 102261	● 102238
1/2	14	20.95	125	22	16	12	4	18.9		● 102046	● 102256	● 102234
5/8	14	22.91	125	25	18	14.5	4	20.9		● 102054	● 144722	
3/4	14	26.44	140	28	20	16	4	24.4		● 102052	● 102260	● 102237
1	11	33.24	160	32	25	20	4	30.7		● 102049	● 102259	
1 1/4	11	41.91	170	32	32	24	5	39.3		● 102043		
1 1/2	11	47.8	190	32	36	29	5	45.2		● 102042		
2	11	59.61	220	36	45	35	5	57		● 102051		
2 1/2	11	75.18	280	36	50	39	6	72.6		● 102050		



# G DIN EN ISO 228 (BSP)

HSSE



										N460-3	N460V-3	N460TN-3	N462V-3
Ø" d1 G	P TPI	d1 mm	l1 mm	l2 mm	d2 mm	a mm			ID	ID	ID	ID	
1/16	28	7.72	90	12.5	6	4.9	3	6.75	● 102341				
1/8	28	9.72	90	14	7	5.5	3	8.75	● 102344	● 102457	● 102444	● 143687	
1/4	19	13.15	100	14	11	9	3	11.6	● 102343	● 102456	● 102443	● 143600	
3/8	19	16.66	100	14	12	9	4	15.2	● 102348	● 102460	● 102446	● 143431	
1/2	14	20.95	125	20	16	12	4	18.9	● 102342	● 102455	● 102442	● 143921	
5/8	14	22.91	125	20	18	14.5	4	20.9	● 102349	● 143711			
3/4	14	26.44	140	22	20	16	4	24.4	● 102347	● 102459	● 102445	● 143688	
1	11	33.24	160	26	25	20	4	30.7	● 102345	● 102458			
1 1/4	11	41.91	170	30	32	24	5	39.3	● 102340	● 111608			
1 1/2	11	47.8	190	35	36	29	5	45.2	● 102339	● 111609			
2	11	59.61	220	41	45	35	6	57	● 102346	● 111503			

# G DIN EN ISO 228 (BSP)

≤ Ø 25.4 > Ø 25.4

**HSSE**  
W

**PM**  
H/GG

**HSSE**  
H/GG

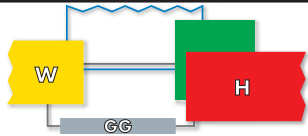

**W460-5**      **W460DL-5**      **H450-3**      **GG450NV-3**

**W460-5** **71 72 81**

**W460DL-5** **71 72 73**



**H450-3** **15 16 62 64 82**

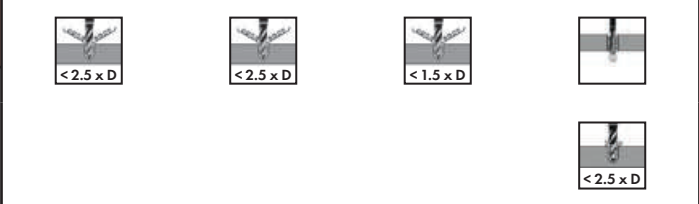

**GG450NV-3** **31**

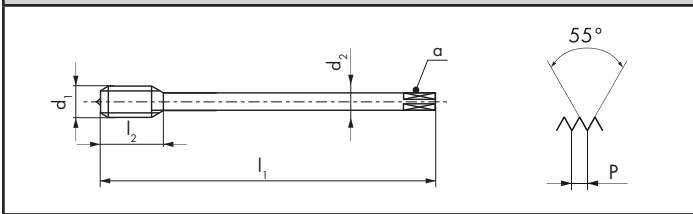

Ø" d <sub>1</sub> G	P TPI	d <sub>1</sub> mm	l <sub>1</sub> mm	l <sub>2</sub> mm	d <sub>2</sub> mm	a mm		
1/8	28	9.72	90	14	7	5.5	3	8.75
1/4	19	13.15	100	14	11	9	* 4	11.6
3/8	19	16.66	100	14	12	9	4	15.2
1/2	14	20.95	125	20	16	12	4	18.9
3/4	14	26.44	140	22	20	16	4	24.4
1	11	33.24	160	26	25	20	4	30.7

ID	ID	ID
● 119350	● 176728	● 101298
● 119300	● 176729	● 101297
● 119682	● 176730	● 101301
● 119199	● 176731	● 101296
		● 101300
		● 101299

\* W460-5 = 3  
\* W460DL-5 = 3

Ø" d <sub>1</sub> G	P TPI	d <sub>1</sub> mm	l <sub>1</sub> mm	l <sub>2</sub> mm	d <sub>2</sub> mm	a mm		
1/8	28	9.72	90	22	7	5.5	4	8.75
1/4	19	13.15	100	20	11	9	4	11.6
3/8	19	16.66	100	20	12	9	4	15.2
1/2	14	20.95	125	22	16	12	4	18.9
3/4	14	26.44	140	28	20	16	4	24.4
1	11	33.24	160	32	25	20	4	30.7

ID
● 102309
● 102308
● 102312
● 102307
● 102311
● 102310

# G DIN EN ISO 228 (BSP)

< Ø 25.4 > Ø 25.4

<b>PM</b>	<b>HSSE</b>	<b>HSSE</b>
Z420	Z420	Z460



										Z420V-4	Z420VS-4	Z460V-3	
<b>Z420V-4</b>		<b>V</b>	<div style="display: flex; flex-wrap: wrap; gap: 5px;"> <span>11</span><span>12</span><span>13</span><span>21</span>  <span>32</span> </div>										
<b>Z420VS-4</b>		<b>VS</b>	<div style="display: flex; flex-wrap: wrap; gap: 5px;"> <span>11</span><span>12</span><span>13</span><span>14</span>  <span>21</span><span>22</span><span>23</span><span>32</span>  <span>61</span><span>63</span><span>94</span> </div>										
<b>Z460V-3</b>		<b>V</b>	<div style="display: flex; flex-wrap: wrap; gap: 5px;"> <span>12</span><span>21</span><span>32</span> </div>										
Ø" d <sub>1</sub> G	P TPI	d <sub>1</sub> mm	l <sub>1</sub> mm	l <sub>2</sub> mm	d <sub>2</sub> mm	a mm				ID	ID		
1/8	28	9.72	90	22	7	5.5	3	8.75	●	142794	●	142800	
1/4	19	13.15	100	20	11	9	3	11.6	●	142795	●	119303	
3/8	19	16.66	100	20	12	9	3	15.2	●	142796	●	142802	
1/2	14	20.95	125	22	16	12	4	18.9	●	142797	●	142803	
3/4	14	26.44	140	28	20	16	4	24.4	●	142798			
1	11	33.24	160	32	25	20	4	30.7	●	142799			
Ø" d <sub>1</sub> G	P TPI	d <sub>1</sub> mm	l <sub>1</sub> mm	l <sub>2</sub> mm	d <sub>2</sub> mm	a mm				ID			
1/8	28	9.72	90	14	7	5.5	3	8.75		● 104726			
1/4	19	13.15	100	14	11	9	3	11.6		● 104725			
3/8	19	16.66	100	14	12	9	4	15.2		● 104728			
1/2	14	20.95	125	20	16	12	4	18.9		● 104724			
3/4	14	26.44	140	22	20	16	4	24.4		● 104727			
1	11	33.24	160	26	25	20	4	30.7		● 105142			

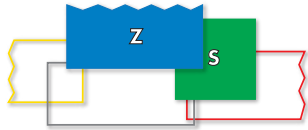

Z470VS-3

Z470VS-3



VS



Z470VS-3



VS

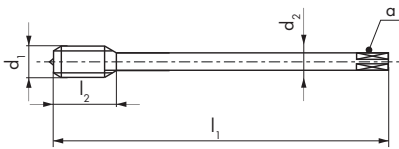

$\frac{\text{Ø}''}{G} d_1$	P TPI	$d_1$ mm	$l_1$ mm	$l_2$ mm	$d_2 h_6$ mm	$a$ mm			ID
1/8	28	9.72	100	14	* 8	* 6.2	3	8.75	● 165198
1/4	19	13.15	110	14	* 12	* 9	4	11.6	● 165199
3/8	19	16.66	110	18	12	9	4	15.2	● 165200
1/2	14	20.95	125	20	16	12	4	18.9	● 165201

\* Norme DC / \* DC Norm/ \* Norma DC



# QTAP

Q420VS-4



VS

Q423VS-4

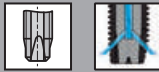

VS

- 11
- 12
- 13
- 14
- 15
- 21
- 22
- 23
- 24
- 31
- 32
- 51
- 52
- 61
- 62
- 63
- 64
- 71
- 72
- 73
- 74
- 81
- 82
- 83
- 91
- 92
- 94

Q420VS-4

Q423VS-4



NEW



NEW

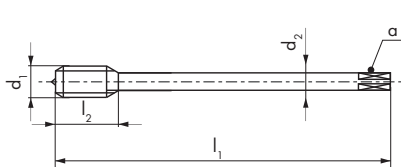

Ø" d <sub>1</sub> G	P TPI	d <sub>1</sub> mm	l <sub>1</sub> mm	l <sub>2</sub> mm	d <sub>2</sub> mm	a mm		
1/8	28	9.72	90	22	7	5.5	3	8.75
1/4	19	13.15	100	20	11	9	3	11.6
3/8	19	16.66	100	20	12	9	3	15.2
1/2	14	20.95	125	22	16	12	4	18.9

ID

ID

● 196312

● 197645

● 196313

● 197646

● 196314

● 197647

● 196315

● 197648

# G

## DIN EN ISO 228 (BSP)



≤ Ø 16 > Ø 16

PM

HSSE



# QTAP

Q460VS-3



Q463VS-3



- 11 12 13 14
- 15 21 22 23
- 24 31 32 51
- 52 61 62 63
- 64 71 72 73
- 74 81 82 83
- 91 92 94

Q460VS-3

Q463VS-3



NEW



NEW



< 2.5 x D



< 2.5 x D

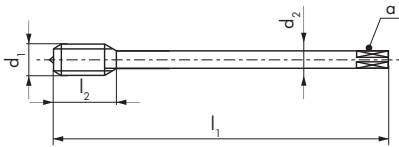

2.5 x P



2.5 x P

Ø" d <sub>1</sub> G	P TPI	d <sub>1</sub> mm	l <sub>1</sub> mm	l <sub>2</sub> mm	d <sub>2</sub> mm	a mm		
1/8	28	9.72	90	14	7	5.5	3	8.75
1/4	19	13.15	100	14	11	9	3	11.6
3/8	19	16.66	100	14	12	9	4	15.2
1/2	14	20.95	125	20	16	12	4	18.9

ID

ID

● 196316

● 197649

● 196317

● 197650

● 196318

● 197651

● 196319

● 197652

G (BSP)

# G

## DIN EN ISO 228 (BSP)



Uniquement pour taraudage synchrone  
 Nur für Synchrobearbeitung  
 Only for rigid tapping  
 Solo per maschiatura sincrona  
 Solo para rosado sincrozado  
 Только для rigid tapping

PM



# RTS

Rigid Tapping Synchro

RTS462VS-3



RTS462VS-5



RTS462VS-3

RTS462VS-5

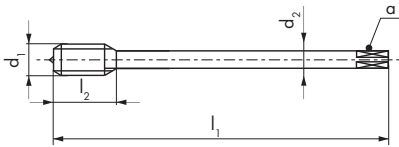

Ø" d <sub>1</sub> G	P TPI	d <sub>1</sub> mm	l <sub>1</sub> mm	l <sub>2</sub> mm	d <sub>2</sub> h6 mm	a mm		
1/8	28	9.72	100	14	* 8	* 6.2	3	8.75
1/4	19	13.15	110	14	* 12	* 9	3	11.6
3/8	19	16.66	110	18	12	9	4	15.2
1/2	14	20.95	125	20	16	12	4	18.9

ID	ID
● 151861	● 170629
● 151868	● 170631
● 151872	● 170633
● 150685	● 170635

\* Norme DC / \* DC Norm/ \* Norma DC



sur demande  
 auf Anfrage  
 on request  
 su richiesta  
 sobre pedido  
 no zapytany



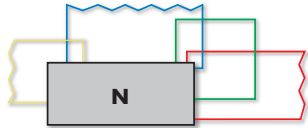

<b>N210-1</b>			
<b>N210-3</b>			<b>31</b> <b>62</b> <b>73</b> <b>74</b> <b>91</b>
<b>N210-S</b>			

N210-1	N210-3	N210-S	
--------	--------	--------	--



	$< 1.5 \times D$	$< 2.5 \times D$
--	------------------	------------------

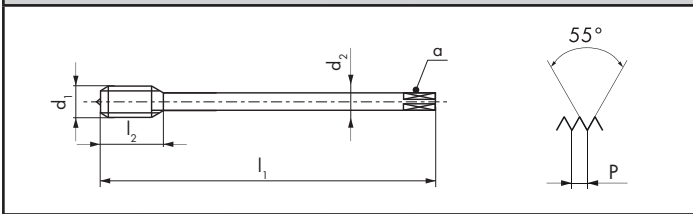

--	--

$\frac{\text{Ø}''}{G}$ $d_1$	P TPI	$d_1$ mm	$l_1$ mm	$l_2$ mm	$d_2$ mm	a mm			ID	ID	ID
1/16	28	7.72	63	18	6	4.9	3	6.75		● 101418	
1/8	28	9.72	63	22	7	5.5	3	8.75	● 101404	● 101421	● 119386
1/4	19	13.15	70	20	11	9	3	11.6	● 101403	● 101420	● 119336
3/8	19	16.66	70	20	12	9	4	15.2	● 101409	● 101427	● 110938
1/2	14	20.95	80	22	16	12	4	18.9	● 101402	● 101419	● 119264
5/8	14	22.91	80	25	18	14.5	4	20.9	● 101411	● 105140	● 110940
3/4	14	26.44	90	28	20	16	4	24.4	● 101408	● 101426	● 110937
1	11	33.24	100	32	25	20	4	30.7	● 101405	● 101422	● 110933
1 1/8	11	37.89	125	32	28	22	4	35.3		● 101415	
1 1/4	11	41.91	125	32	32	24	5	39.3	● 101400	● 101414	● 111425
1 1/2	11	47.8	140	32	36	29	5	45.2	● 101399	● 101413	● 110934
2	11	59.61	160	36	45	35	5	57	● 101407	● 101425	● 110935
2 1/2	11	75.18	160	36	50	39	6	72.6		● 101423	

# Rp, Rc DIN EN 10226

HSSE

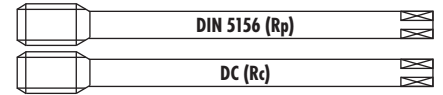

										N420-3			N410-3
<b>N420-3</b> <span style="float: right;"> <span style="border: 1px solid black; padding: 2px;">62</span> <span style="border: 1px solid black; padding: 2px;">63</span> <span style="border: 1px solid black; padding: 2px;">64</span> <span style="border: 1px solid black; padding: 2px;">72</span> <span style="border: 1px solid black; padding: 2px;">73</span> <span style="border: 1px solid black; padding: 2px;">74</span>  <span style="border: 1px solid black; padding: 2px;">81</span> <span style="border: 1px solid black; padding: 2px;">91</span> </span>													
<b>N410-3</b> <span style="float: right;"> <span style="border: 1px solid black; padding: 2px;">31</span> <span style="border: 1px solid black; padding: 2px;">62</span> <span style="border: 1px solid black; padding: 2px;">74</span> </span>													
$\emptyset'' d_1$ Rp	P TPI	$d_1$ mm	$l_1$ mm	$l_2$ mm	$d_2$ mm	$a$ mm				ID			
1/8	28	9.72	90	22	7	5.5	3	8.6		● 104911			
1/4	19	13.15	100	20	11	9	3	11.5		● 104912			
3/8	19	16.66	100	20	12	9	3	15		● 104913			
1/2	14	20.95	125	22	16	12	4	18.5		● 104914			
3/4	14	26.44	140	28	20	16	4	24		● 104915			
1	11	33.24	160	32	25	20	4	30.25		● 104916			
$\emptyset'' d_1$ Rc	P TPI	$d_1$ mm	$l_1$ mm	$l_2$ mm	$d_2$ mm	$a$ mm				ID			
1/8	28	9.72	71	13	8	6.2	5			● 104917			
1/4	19	13.15	80	20	11	9	5			● 104918			
3/8	19	16.66	90	20	12	9	5			● 104919			
1/2	14	20.95	100	26	16	12	5			● 104920			
3/4	14	26.44	110	26	20	16	5			● 104921			
1	11	33.24	125	32	25	20	5			● 104922			

Vc (m/min) $\emptyset d_1$ - Guide Line				
Rc	1/16" - 1/4"	3/8" - 1/2"	3/4" - 1"	1.1/4" - 2"
<span style="border: 1px solid black; padding: 2px;">31</span> <span style="border: 1px solid black; padding: 2px;">74</span>	10	8	7	5
<span style="border: 1px solid black; padding: 2px;">62</span>	18	15	13	10

					D5800			
					<b>ID</b>			
$\frac{\text{Ø}''}{\text{Rc}}$	$l_1$ mm	$l_2$ mm	$d_2$ mm	$a$ mm				
1/16	70	17	6	4.9	● 118701			
1/8	70	17	8	6.2	● 110531			
1/4	80	27	10	8	● 110530			
3/8	85	27	12	9	● 110535			
1/2	95	35	16	12	● 110529			
3/4	105	35	20	16	● 110534			
1	130	43	25	20	● 110532			

## Kernloch-Durchmesser für kegeliges Rohrgewinde nach DIN EN 10226 Core hole diameters for tapered pipe thread to DIN EN 10226

**Bohrung zylindrisch**  
Vermeiden, da schnellere  
Abnutzung des Gewindebohrers  
und Klemmen

**Parallel hole**  
Increased tap wear,  
not recommended

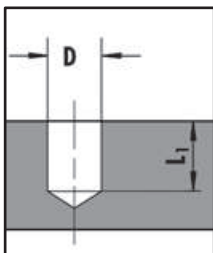

**Bohrung konisch 1:16**  
Zylindrisch bohren nach  $\text{Ø } D_2$   
und konisch aufreiben auf  $\text{Ø } D_3$

**Tapered hole 1:16**  
Pre-drill at  $\text{Ø } D_2$   
and taper-ream to  $\text{Ø } D_3$

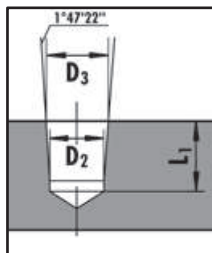

**Gewindeschneiden**  
Gewindebohrer auf Nennmass  
 $l_2$  eindrehen

**Tapped hole**  
Engage tap to hole depth  
 $l_2 = \text{nominal } \text{Ø}$

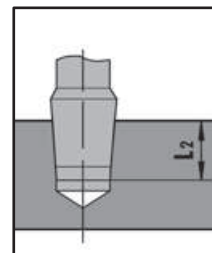

$\frac{\text{Ø}''}{\text{Rc}}$	$l_1$ min. mm	$D_1$ mm	$D_2$ mm	$D_3$ mm	$l_2$ mm
1/16	11.9	6.2	6.1	6.56	10.6
1/8	11.9	8.2	8.1	8.57	10.6
1/4	17.7	11	10.75	11.45	15.7
3/8	18.1	14.5	14.25	14.95	16.1
1/2	24	18	17.75	18.63	21.4
3/4	25.3	23.5	23	24.12	21.5
1	30.6	29.5	29	30.29	26.3

# W BS 84 (BSW)

HSS

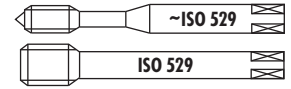



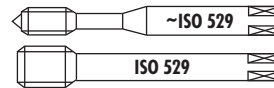











										N1110-3	N1210-3	N1120-4	N1220-4
N1110-3			31	62	73	74	91						
N1210-3			31	62	73	74	91						
N1120-4			62	63	64	72	73	74	81	91			
N1220-4			62	63	64	72	73	74	81	91			
$\emptyset$ " d <sub>1</sub>	P	d <sub>1</sub>	l <sub>1</sub>	l <sub>2</sub>	l <sub>3</sub>	d <sub>2</sub>	a			ID	ID	ID	ID
W	TPI	mm	mm	mm	mm	mm	mm						
1/8	40	3.17	48	11	18	3.15	2.5	3	2.5	● 103025		● 103126	
5/32	32	3.96	53	13	21	4	3.15	3	3.1	● 103031		● 103130	
3/16	24	4.76	58	16	25	5	4	3	3.6	● 103026		● 103127	
1/4	20	6.35	66	19	30	6.3	5	3	4.9	● 103024		● 103125	
5/16	18	7.93	72	22	35	8	6.3	3	6.4	● 103030		● 103129	
3/8	16	9.52	80	24	39	10	8	3	7.7	● 103028		● 103128	
7/16	14	11.11	85	22		8	6.3	3	9.1		● 103642		● 103771
1/2	12	12.7	89	24		9	7.1	3	10.3		● 103634		● 103767
5/8	11	15.87	102	32		12.5	10	3	13.3		● 103641		● 103770
3/4	10	19.05	112	33		14	11.2	3	16.2		● 103640		● 103769



										N1110-3	N1210-3	N5120	
N1110-3			31 / 62 / 73 / 74 / 91										
N1210-3			31 / 62 / 73 / 74 / 91										
N5120			11 / 12										
$\emptyset d_1$	P	$l_1$	$l_2$	$l_3$	$d_2$	a			ID				
W	TPI/mm	B6	58	16	25	5	4	3	4.3*	● 103029			
5	36/TPI/1"	B8	66	19	30	7.1	5.6	3	6.2*	● 111143			
6.82	0.625												
$\emptyset d_1$	P	$l_1$	$l_2$	$l_3$	$d_2$	a			ID	ID			
SV	mm	W10	80	24	39	10	8	3	* 8.9	● 130429			
10	0.833	W12	89	24		9	7.1	3	* 10.5	● 103591			
12	1.25	W15	90	23		11.2	9	3	* 13.5	● 103592			
15	1.25	W20	112	37		14	11.2	4	* 17.9	● 103593			
20	1.666	W25	120	30		18	14	4	* 22.75	● 103594			
25	1.693												
* Tol. $\begin{matrix} +0.1 \text{ mm} \\ 0 \end{matrix}$													
$\emptyset d_1$	P	$d_2$	$l_1$			ID							
W	mm	B8	25	9	4	● 130215							
6.82	0.625												

# NPT, NPTF

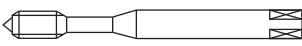
Maschinengewindebohrer, NPT ASME B1.20.1 und NPTF ANSI B1.20.3  
Machine taps, NPT ASME B1.20.1 and NPTF ANSI B1.20.3

		N			
<b>Merkmale</b> Characteristics			 	 	 1:16
					
<b>Lochart</b> Hole type					
					
		<b>N410-3</b>	<b>N410V-3</b>	<b>N411V-3</b>	<b>D5800</b>
<b>NPT DIN lang</b> NPT DIN long	DC	220	220	220	221
<b>NPTF DIN lang</b> NPTF DIN long	DC	220			

# PG, TR

Maschinen- und Handgewindebohrer, PG DIN 40430, TR ISO 2901-2904, DIN 103  
Machine and hand taps, PG DIN 40430, TR ISO 2901-2904, DIN 103

		N					
<b>Merkmale</b> Characteristics							
<b>Lochart</b> Hole type							
		<b>N420-3</b>	<b>N410-1</b>	<b>N410-2</b>	<b>N410-3</b>	<b>N410-S</b>	<b>N410-8</b>
<b>PG DIN lang</b> <b>PG DIN long</b>	<b>DIN 40433</b>	222					
<b>TR DIN lang</b> <b>TR DIN long</b>	<b>DC</b>		223	223	223	223	222
<b>Toleranz</b> <b>Tolerance</b>	<b>TR 7H</b>				223	223	222



# NPT, NPTF

ASME B1.20.1, ANSI B1.20.3

HSSE



							N410-3	N410V-3	N411V-3	N410-3	
N410-3				31 62 74							
N410V-3		V			11 12 14 21 32						
N411V-3			V			11 12 14 21 32					
N410-3				31 62 74							
Ø" d <sub>1</sub> NPT, NPTF	P TPI	l <sub>1</sub> mm	l <sub>2</sub> mm	d <sub>2</sub> mm	a mm		ID	ID	ID	ID	
1/16	27	71	13	7	5.5	3	● 101961	● 102021	● 102031	● 101971	
1/8	27	71	13	8	6.2	5	● 101964	● 102024	● 102034	● 101974	
1/4	18	80	20	11	9	5	● 101963	● 102023	● 102033	● 101973	
3/8	18	90	20	12	9	5	● 101968	● 102028	● 102038	● 101978	
1/2	14	100	26	16	12	5	● 101962	● 102022	● 102032	● 101972	
3/4	14	110	26	20	16	5	● 101967	● 102027	● 102037	● 101977	
1	11.5	125	32	25	20	5	● 101965	● 102025	● 102035	● 101975	
1 1/4	11.5	125	32	32	24	5	● 101960	● 102020			
1 1/2	11.5	140	32	36	29	5	● 101959	● 102019			
2	11.5	160	32	36	29	7	● 101966	● 102026			

Vc (m/min) Ø d1 - Guide Line				
NPT, NPTF	1/16" - 1/4"	3/8" - 1/2"	3/4" - 1"	1.1/4" - 2"
11 12 14 32	6	5	4	3
21	5	4	3	2
31 74	10	8	7	5
62	18	15	13	10

# NPT, NPTF

ASME B1.20.1, ANSI B1.20.3

HSSE



					D5800
<b>D5800</b>					
<b>Ø"</b> <b>NPT, NPTF</b>	<b>l<sub>1</sub></b> mm	<b>l<sub>2</sub></b> mm	<b>d<sub>2</sub></b> mm	<b>a</b> mm	
1/16	70	17	6	4.9	● 118701
1/8	70	17	8	6.2	● 110531
1/4	80	27	10	8	● 110530
3/8	85	27	12	9	● 110535
1/2	95	35	16	12	● 110529
3/4	105	35	20	16	● 110534
1	130	43	25	20	● 110532

## Kernloch-Durchmesser für NPT- und NPTF-Gewinde Core hole diameters for NPT and NPTF threads

**Bohrung zylindrisch**  
Vermeiden, da schnellere  
Abnützung des Gewindebohrers  
und Klemmen

**Parallel hole**  
Increased tap wear,  
not recommended

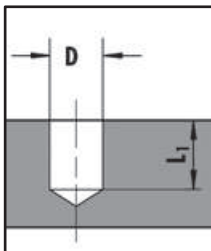

**Bohrung konisch 1:16**  
Zylindrisch bohren nach Ø D<sub>2</sub>  
und konisch aufreiben auf Ø D<sub>3</sub>

**Tapered hole 1:16**  
Pre-drill at Ø D<sub>2</sub>  
and taper-ream to Ø D<sub>3</sub>

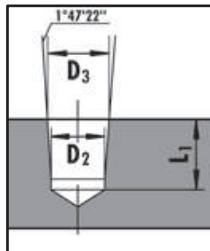

**Gewindeschneiden**  
Gewindebohrer auf Nennmass  
L<sub>3</sub> eindrehen

**Tapped hole**  
Engage tap to hole depth  
L<sub>3</sub> = nominal Ø

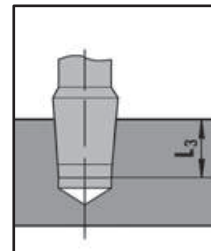

\*Es wird empfohlen, das  
Kernloch auf D<sub>3</sub> maxi  
konisch aufzureiben.  
\*Taper-ream at upper limit  
D<sub>3</sub> is recommended







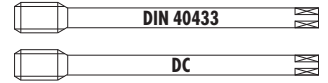

Ø" NPT, NPTF	D mm	L <sub>1</sub> mm	D <sub>2</sub> mm	NPT	NPTF	L <sub>3</sub> mm
				D <sub>3</sub> (+0.05) mm	D <sub>3</sub> (+0.05) mm	
1/16	6.15	12	6	6.39	6.41	10.2
1/8	8.5	12	8.3	8.74	8.76	10.3
1/4	11	17.5	10.8	11.36	11.4	15.1
3/8	14.5	17.5	14.2	14.8	14.84	15.3
1/2	17.9	23	17.5	18.32	18.33	20
3/4	23.2	23	22.8	23.67	23.68	20.5
1	29	28	28.6	29.69	29.72	24.6

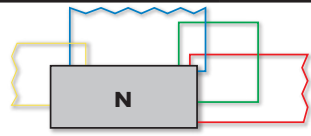





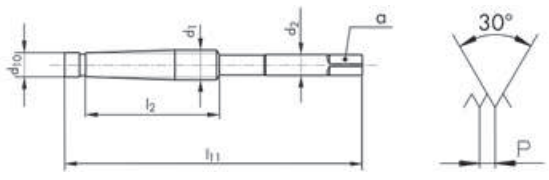

















# PG DIN 40430 TR ISO 2901-2904, DIN 103

HSSE





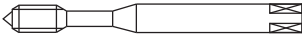











										N420-3			N410-8
<b>N420-3</b> <b>61 63 71 72 73 81</b>													
<b>N410-8</b> <b>31 62 74</b>										<b>&lt; 1.5 x D</b>			
										<b>2.5 x P</b>			
$\emptyset d_1$ PG	P TPI	$d_1$ mm	$l_1$ mm	$l_2$ mm	$d_2$ mm	$a$ mm				ID			
7	20	12.5	100	24	9	7	3	11.3	●	104901			
9	18	15.2	100	26	12	9	3	13.9	●	104902			
11	18	18.6	110	26	14	11	4	17.3	●	104903			
13.5	18	20.4	125	28	16	12	4	19.1	●	104904			
16	18	22.5	125	28	18	14.5	4	21.2	●	104905			
21	16	28.3	150	36	22	18	4	26.8	●	104906			
29	16	37	170	38	28	22	4	35.5	●	104907			
36	16	47	190	38	36	29	5	45.5	●	104908			
										<b>7H</b>			
$\emptyset d_1$ TR	P mm	$l_{11}$ mm	$l_2$ mm	$d_{10}$ mm	$d_2$ mm	$a$ mm				ID			
10	2	100	45	8.2	7	5.5	3	8.2	●	102008			
12	3	140	75	9.25	8	6.2	3	9.25	●	102009			
14	3	150	75	11.25	10	8	3	11.25	●	102010			
16	4	180	100	12.25	11	9	3	12.25	●	102011			
18	4	180	100	14.25	12	9	3	14.25	●	102012			
20	4	190	100	16.25	14	11	3	16.25	●	102013			
22	5	220	110	17.25	16	12	4	17.25	●	111616			
24	5	220	110	19.25	18	14.5	4	19.25	●	102015			

										N410-1	N410-2	N410-3	N410-S
<b>N410-1</b> 													
<b>N410-2</b> 													
<b>N410-3</b> 													
<b>N410-S</b> 													
										7H		7H	
$\emptyset d_1$ TR	P mm	$l_{11}$ mm	$l_2$ mm	$d_{10}$ mm	$d_2$ mm	a mm				ID	ID	ID	ID
10	2	85	30	8.2	7	5.5	3	8.2		* 101827	* 101838	* 101979	* 110972
16	4	165	65	12.25	11	9	3	12.25		* 101830	* 101841	* 101982	* 110975
<p>Zufolge der geringen Nachfrage führen wir TR-Gewindebohrer-Sätze nicht mehr im Standard-Programm. Auf Wunsch bieten wir Ihnen diese gerne als Spezialanfertigung an, Preis und Lieferfrist auf Anfrage.</p> <p>Due to low demand, we no longer keep TR tap sets in our standard programme. On request, we will be pleased to offer these as custom-made products, price and delivery time on demand.</p>													

	N				Z	S	
<b>Merkmale</b> <b>Characteristics</b> 		 V	 R40	 R40 V	 R45 VS	 VS	 R35 VS
							
<b>Lochart</b> <b>Hole type</b>							
	<b>N320-4</b>	<b>N320V-4</b>	<b>N360-3</b>	<b>N360V-3</b>	<b>Z370VS-3</b>	<b>S320VS-4</b>	<b>S360VS-3</b>
<b>DIN lang</b> <b>DIN long</b> ~DIN 40435	226	226	227	227			
<b>DIN lang</b> <b>DIN long</b> ~DIN 2184-1	230 / 233		230 / 233		231 / 234	234	234
<b>Gewinde</b> <b>Thread</b> EG M	226	226	227	227			
<b>Gewinde</b> <b>Thread</b> EG UNC	230		230		231		
<b>Gewinde</b> <b>Thread</b> EG UNF	233		233		234	234	234
	<b>N420-4</b>	<b>N420V-4</b>	<b>N460-3</b>	<b>N460V-3</b>			
<b>DIN lang</b> <b>DIN long</b> ~DIN 40435	226	226	227	227			
<b>DIN lang</b> <b>DIN long</b> ~DIN 2184-1	230 / 233		230 / 233				
<b>Gewinde</b> <b>Thread</b> EG M	226	226	227	227			
<b>Gewinde</b> <b>Thread</b> EG UNC	230		230				
<b>Gewinde</b> <b>Thread</b> EG UNF	233		233				

**EG** *Maschinengewindebohrer, Aufnahmegewinde für Gewindeeinsätze EG M, EG UNC, EG UNF*  
**Machine taps for wire screw thread inserts EG M, EG UNC, EG UNF**

SA			TL	
	 R15	 R10	 VS	 R15 VS
				
				
SA320-4	SA350-3	SA390-3	TL320VS-4	TL351VS-3
228	228	229		228
232 / 235	232 / 235	234	232	232 / 235
228	228	229		228
232	232		232	232
235	235	234		235

**...MEHR INFORMATIONEN AUF UNSERER WEBSITE**  
**...MORE INFORMATION ON OUR WEBSITE**  
[www.dcswiss.com](http://www.dcswiss.com)



EG M, EG UNC,  
 EG UNF

# EG M ISO DIN 8140



≤ Ø 2.8 > Ø 2.8

PM

HSSE

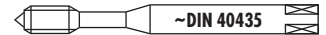

										N320-4	N320V-4	N420-4	N420V-4
N320-4													
N320V-4		V											
N420-4													
N420V-4		V											
<b>Ø d<sub>1</sub></b> EG M	<b>P</b> mm	<b>d<sub>1</sub></b> mm	<b>l<sub>1</sub></b> mm	<b>l<sub>2</sub></b> mm	<b>l<sub>3</sub></b> mm	<b>d<sub>2</sub></b> mm	<b>a</b> mm			<b>ID</b>	<b>ID</b>	<b>ID</b>	<b>ID</b>
2	0.4	2.52	50	10		2.8	2.1	3	2.1	● 101537	● 118788		
2.5	0.45	3.08	56	12	18	3.5	2.7	3	2.65	● 101538			
3	0.5	3.65	56	13	20	4	3	3	3.15	● 101539	● 142804		
4	0.7	4.91	70	15	25	6	4.9	3	4.2	● 101540	● 142805		
5	0.8	6.04	80	17	30	6	4.9	3	5.25	● 101541	● 142806		
6	1	7.3	80	17	30	7	5.5	3	6.3	● 101542	● 142807		
8	1.25	9.62	100	22	39	10	8	3	8.4	● 101543	● 142808		
10	1.5	11.94	100	24		9	7	3	10.4			● 102252	● 142809
12	1.75	14.27	110	28		11	9	3	12.5			● 102253	● 142810
16	2	18.59	125	33		14	11	3	16.6			● 102255	● 142812



# EG M ISO DIN 8140



≤ Ø 2.8 > Ø 2.8

PM

HSSE

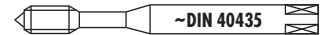

										N360-3	N360V-3	N460-3	N460V-3
N360-3		63 72 73 74 81 91											
N360V-3			11 12 32										
N460-3		63 72 73 74 81 91											
N460V-3			11 12 32										
Ø d <sub>1</sub> EG M	P mm	d <sub>1</sub> mm	l <sub>1</sub> mm	l <sub>2</sub> mm	l <sub>3</sub> mm	d <sub>2</sub> mm	a mm			ID	ID	ID	ID
2	0.4	2.52	50	9		2.8	2.1	2	2.1	● 101599			
2.5	0.45	3.08	56	5.5	18	3.5	2.7	3	2.65	● 101600			
3	0.5	3.65	56	6.5	20	4	3	3	3.15	● 101601	● 142813		
4	0.7	4.91	70	9	25	6	4.9	3	4.2	● 101602	● 142814		
5	0.8	6.04	80	11	30	6	4.9	3	5.25	● 101603	● 142815		
6	1	7.3	80	11	30	7	5.5	3	6.3	● 101604	● 142816		
8	1.25	9.62	100	14	39	10	8	3	8.4	● 101605	● 142817		
10	1.5	11.94	100	14		9	7	3	10.4			● 102335	● 142818
12	1.75	14.27	110	14		11	9	3	12.5			● 102336	● 142819
14	2	16.59	110	18		12	9	3	14.6			● 102337	● 142820
16	2	18.59	125	21		14	11	3	16.6			● 102338	● 142821



PM



## aero

SA320-4



15 16 52 64

SA350-3



15 16 52 64

TL351VS-3



VS

41 42

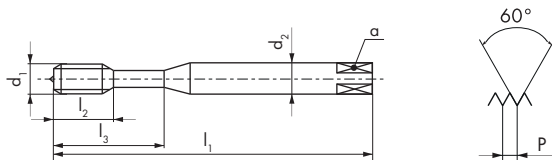

SA320-4

SA350-3

TL351VS-3



$\emptyset d_1$ EG M	P mm	$d_1$ mm	$l_1$ mm	$l_2$ mm	$l_3$ mm	$d_2$ mm	a mm			ID	ID	ID
3	0.5	3.65	56	13		4	3	3	3.15	● 147676	● 147682	● 150478
4	0.7	4.91	70	15		6	4.9	3	4.2	● 147678	● 147684	● 152003
5	0.8	6.04	80	15	23	6	4.9	3	5.25	● 147680	● 147686	● 150184
6	1	7.3	80	15	23	7	5.5	3	6.3	● 147688	● 147692	● 152005
8	1.25	9.62	100	20	33	10	8	3	8.4	● 149354	● 149356	● 152089



PM



## aero

SA390-3



16 53

SA390-3

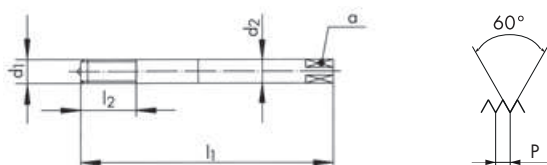

$\emptyset d_1$ EG M	P mm	$d_1$ mm	$l_1$ mm	$l_2$ mm	$d_2$ mm	a mm		
3	0.5	3.65	56	13	4	3	3	3.15
4	0.7	4.91	70	15	6	4.9	3	4.2
5	0.8	6.04	80	20	6	4.9	3	5.25
6	1	7.3	80	20	7	5.5	3	6.3
8	1.25	9.62	100	30	10	8	3	8.4
10	1.5	11.94	110	35	12	9	3	10.4

ID

- 149669
- 149688
- 149710
- 149723
- 149748
- 149767

# EG UNC ASME B18.29.1



HSSE

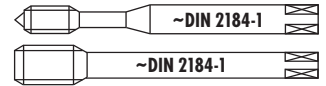

										N320-4	N420-4	N360-3	N460-3
N320-4		62 63 64 72 73 74 81 91											
N420-4		62 63 64 72 73 74 81 91											
N360-3		63 72 73 74 81 91											
N460-3		63 72 73 74 81 91											
										3B		3B	
Ø" d <sub>1</sub> EG UNC	P TPI	d <sub>1</sub> mm	l <sub>1</sub> mm	l <sub>2</sub> mm	l <sub>3</sub> mm	d <sub>2</sub> mm	a mm			ID	ID	ID	ID
4	40	3.67	56	13	20	4	3	3	3.05	● 110946			
6	32	4.53	70	15	25	6	4.9	3	3.75	● 110948			
8	32	5.19	70	15	25	6	4.9	3	4.45	● 110949			
1/4	20	8	90	20	35	8	6.2	3	6.7	● 110944			
5/16	18	9.77	100	22	39	10	8	3	8.4	● 110947			
3/8	16	11.58	110	24		9	7	3	10		● 110033		
1/2	13	15.23	110	30		12	9	3	13.3		● 104935		
Ø" d <sub>1</sub> EG UNC	P TPI	d <sub>1</sub> mm	l <sub>1</sub> mm	l <sub>2</sub> mm	l <sub>3</sub> mm	d <sub>2</sub> mm	a mm			ID	ID	ID	ID
4	40	3.67	56	6.5	20	4	3	3	3.05		● 110018		
6	32	4.53	70	9	25	6	4.9	3	3.75		● 110019		
8	32	5.19	70	9	25	6	4.9	3	4.45		● 110956		
10	24	6.2	80	11	30	7	5.5	3	5.1		● 110954		
1/4	20	8	90	12.5	35	8	6.2	3	6.7		● 110024		
5/16	18	9.77	100	14	39	10	8	3	8.4		● 111759		
3/8	16	11.58	110	14		9	7	3	10			● 111715	
1/2	13	15.23	110	18		12	9	3	13.3			● 111558	

# EG UNC ASME B18.29.1



PM

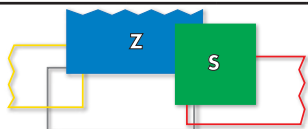
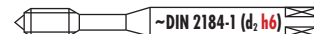

Z370VS-3



VS



Z370VS-3



VS



Z370VS-3

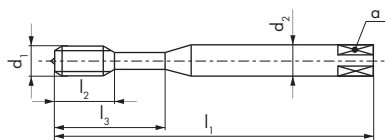

3B

Ø d EG UNC	P TPI	d <sub>1</sub> mm	l <sub>1</sub> mm	l <sub>2</sub> mm	l <sub>3</sub> mm	d <sub>2</sub> h6 mm	a mm		
4	40	3.67	56	6.5	20	4(h9)	3	3	3.05
6	32	4.53	70	9	25	6	4.9	3	3.75
8	32	5.19	70	9	25	6	4.9	3	4.45

ID

● 165126

● 165127

● 165128

# EG UNC ASME B18.29.1



PM



## aero

										SA320-4	SA350-3	TL320VS-4	TL351VS-3						
<div style="display: flex; justify-content: space-between;"> <div style="width: 45%;"> <p><b>SA320-4</b> <span style="float: right;">15 16 52 64</span></p> <p><b>SA350-3</b> <span style="float: right;">15 16 52 64</span></p> </div> <div style="width: 50%; text-align: center;"> </div> </div>																			
<div style="display: flex; justify-content: space-between;"> <div style="width: 45%;"> <p><b>TL320VS-4</b> <b>VS</b> <span style="float: right;">41 42</span></p> <p><b>TL351VS-3</b> <b>VS</b> <span style="float: right;">41 42</span></p> </div> <div style="width: 50%; text-align: center;"> </div> </div>																			
										<div style="display: flex; justify-content: space-around;"> <div style="text-align: center;">   <b>3B</b> </div> <div style="text-align: center;">   <b>3B</b> </div> <div style="text-align: center;">   <b>3B</b> </div> <div style="text-align: center;">   <b>3B</b> </div> </div>									
$\emptyset$ " $d_1$ EG UNC	P TPI	$d_1$ mm	$l_1$ mm	$l_2$ mm	$l_3$ mm	$d_2$ mm	a mm			ID	ID	ID	ID						
4	40	3.67	56	13		4	3			● 149073	● 149075		● 152031						
6	32	4.53	70	15		6	4.9			● 149121	● 149123	* 152040	● 152041						
8	32	5.19	70	15		6	4.9			● 149170	● 149172		● 152053						
1/4	20	8	90	18	29	8	6.2			● 149284	● 149286	* 152073	● 152074						
5/16	18	9.77	100	20	33	10	8				* 149360								

# EG UNF ASME B18.29.1



HSSE

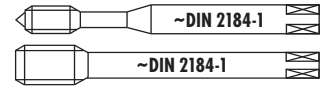

											N320-4	N420-4	N360-3	N460-3						
N320-4		62 63 64 72 73 74 81 91																		
N420-4		62 63 64 72 73 74 81 91																		
N360-3		63 72 73 74 81 91																		
N460-3		63 72 73 74 81 91																		
											<b>3B</b>	<b>3B</b>	<b>3B</b>	<b>3B</b>						
Ø" d <sub>1</sub> EG UNF	P TPI	d <sub>1</sub> mm	l <sub>1</sub> mm	l <sub>2</sub> mm	l <sub>3</sub> mm	d <sub>2</sub> mm	a mm			ID	ID									
6	40	4.33	63	14	21	4.5	3.4	3	3.7	● 118879										
8	36	5.08	70	15	25	6	4.9	3	4.4	● 118882										
10	32	5.85	80	17	30	6	4.9	3	5.1	● 104941										
1/4	28	7.52	90	20	35	8	6.2	3	6.65	● 110234										
5/16	24	9.31	90	20	35	9	7	3	8.2	● 118876										
3/8	24	10.89	100	19		8	6.2	3	9.8		● 118873									
1/2	20	14.35	100	24		11	9	3	13.1		● 118865									
Ø" d <sub>1</sub> EG UNF	P TPI	d <sub>1</sub> mm	l <sub>1</sub> mm	l <sub>2</sub> mm	l <sub>3</sub> mm	d <sub>2</sub> mm	a mm			ID	ID									
6	40	4.33	63	7.5	21	4.5	3.4	3	3.7		● 110959									
8	36	5.08	70	9	25	6	4.9	3	4.4		● 110960									
10	32	5.85	80	11	30	6	4.9	3	5.1		● 104946									
1/4	28	7.52	90	12.5	35	8	6.2	3	6.65		● 110020									
5/16	24	9.31	90	12.5	35	9	7	3	8.2		● 111619									
3/8	24	10.89	100	19		8	6.2	3	9.8			● 110027								
1/2	20	14.35	100	14		11	9	3	13.1			● 104951								

EG UNF



# EG UNF ASME B18.29.1



PM

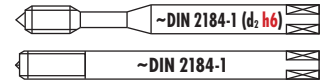

										Z370VS-3	S320VS-4	S360VS-3	SA390-3																																																							
Z370VS-3	R45	VS	CLASSIC	14	15	21	22	23	24																																																											
Z370VS-3	R45	VS	SYNCHRO	13	14	15	21	22	23																																																											
S320VS-4		VS		13	15	16	22	23	24																																																											
S360VS-3	R35	VS		13	15	16	22	23	24																																																											
SA390-3	R10	aero		16	53																																																															
										C	B	C	C																																																							
										2.5 x P	4 x P	2.5 x P	2.5 x P																																																							
										3B	3B	3B	3B																																																							
<table border="1"> <thead> <tr> <th>Ø" d<sub>1</sub> EG UNF</th> <th>P TPI</th> <th>d<sub>1</sub> mm</th> <th>l<sub>1</sub> mm</th> <th>l<sub>2</sub> mm</th> <th>l<sub>3</sub> mm</th> <th>d<sub>2</sub> h6 mm</th> <th>a mm</th> <th></th> <th></th> <th>ID</th> </tr> </thead> <tbody> <tr> <td>10</td> <td>32</td> <td>5.85</td> <td>80</td> <td>11</td> <td>30</td> <td>6</td> <td>4.9</td> <td>3</td> <td>5.1</td> <td>● 165129</td> </tr> <tr> <td>1/4</td> <td>28</td> <td>7.52</td> <td>90</td> <td>12.5</td> <td>35</td> <td>8</td> <td>6.2</td> <td>3</td> <td>6.65</td> <td>● 165130</td> </tr> <tr> <td>5/16</td> <td>24</td> <td>9.31</td> <td>90</td> <td>12.5</td> <td>35</td> <td>* 8</td> <td>* 6.2</td> <td>3</td> <td>8.2</td> <td>● 165131</td> </tr> <tr> <td colspan="11" style="text-align: center;">* Norme DC / * DC Norm/ * Norma DC</td> </tr> </tbody> </table>										Ø" d <sub>1</sub> EG UNF	P TPI	d <sub>1</sub> mm	l <sub>1</sub> mm	l <sub>2</sub> mm	l <sub>3</sub> mm	d <sub>2</sub> h6 mm	a mm			ID	10	32	5.85	80	11	30	6	4.9	3	5.1	● 165129	1/4	28	7.52	90	12.5	35	8	6.2	3	6.65	● 165130	5/16	24	9.31	90	12.5	35	* 8	* 6.2	3	8.2	● 165131	* Norme DC / * DC Norm/ * Norma DC														
Ø" d <sub>1</sub> EG UNF	P TPI	d <sub>1</sub> mm	l <sub>1</sub> mm	l <sub>2</sub> mm	l <sub>3</sub> mm	d <sub>2</sub> h6 mm	a mm			ID																																																										
10	32	5.85	80	11	30	6	4.9	3	5.1	● 165129																																																										
1/4	28	7.52	90	12.5	35	8	6.2	3	6.65	● 165130																																																										
5/16	24	9.31	90	12.5	35	* 8	* 6.2	3	8.2	● 165131																																																										
* Norme DC / * DC Norm/ * Norma DC																																																																				
<table border="1"> <thead> <tr> <th>Ø" d<sub>1</sub> EG UNF</th> <th>P TPI</th> <th>d<sub>1</sub> mm</th> <th>l<sub>1</sub> mm</th> <th>l<sub>2</sub> mm</th> <th>l<sub>3</sub> mm</th> <th>d<sub>2</sub> mm</th> <th>a mm</th> <th></th> <th></th> <th>ID</th> </tr> </thead> <tbody> <tr> <td>10</td> <td>32</td> <td>5.85</td> <td>80</td> <td>17</td> <td>30</td> <td>6</td> <td>4.9</td> <td>3</td> <td>5.1</td> <td>● 111821</td> </tr> <tr> <td>1/4</td> <td>28</td> <td>7.52</td> <td>90</td> <td>20</td> <td>35</td> <td>8</td> <td>6.2</td> <td>3</td> <td>6.65</td> <td>● 111822</td> </tr> <tr> <td>5/16</td> <td>24</td> <td>9.31</td> <td>90</td> <td>20</td> <td>35</td> <td>9</td> <td>7</td> <td>3</td> <td>8.2</td> <td>● 111823</td> </tr> </tbody> </table>										Ø" d <sub>1</sub> EG UNF	P TPI	d <sub>1</sub> mm	l <sub>1</sub> mm	l <sub>2</sub> mm	l <sub>3</sub> mm	d <sub>2</sub> mm	a mm			ID	10	32	5.85	80	17	30	6	4.9	3	5.1	● 111821	1/4	28	7.52	90	20	35	8	6.2	3	6.65	● 111822	5/16	24	9.31	90	20	35	9	7	3	8.2	● 111823															
Ø" d <sub>1</sub> EG UNF	P TPI	d <sub>1</sub> mm	l <sub>1</sub> mm	l <sub>2</sub> mm	l <sub>3</sub> mm	d <sub>2</sub> mm	a mm			ID																																																										
10	32	5.85	80	17	30	6	4.9	3	5.1	● 111821																																																										
1/4	28	7.52	90	20	35	8	6.2	3	6.65	● 111822																																																										
5/16	24	9.31	90	20	35	9	7	3	8.2	● 111823																																																										
<table border="1"> <thead> <tr> <th>Ø" d<sub>1</sub> EG UNF</th> <th>P TPI</th> <th>d<sub>1</sub> mm</th> <th>l<sub>1</sub> mm</th> <th>l<sub>2</sub> mm</th> <th>l<sub>3</sub> mm</th> <th>d<sub>2</sub> mm</th> <th>a mm</th> <th></th> <th></th> <th>ID</th> </tr> </thead> <tbody> <tr> <td>10</td> <td>32</td> <td>5.85</td> <td>80</td> <td>11</td> <td>30</td> <td>6</td> <td>4.9</td> <td>3</td> <td>5.1</td> <td>● 111811</td> </tr> <tr> <td>1/4</td> <td>28</td> <td>7.52</td> <td>90</td> <td>12.5</td> <td>35</td> <td>8</td> <td>6.2</td> <td>3</td> <td>6.65</td> <td>● 111812</td> </tr> <tr> <td>5/16</td> <td>24</td> <td>9.31</td> <td>90</td> <td>12.5</td> <td>35</td> <td>9</td> <td>7</td> <td>3</td> <td>8.2</td> <td>● 111824</td> </tr> </tbody> </table>										Ø" d <sub>1</sub> EG UNF	P TPI	d <sub>1</sub> mm	l <sub>1</sub> mm	l <sub>2</sub> mm	l <sub>3</sub> mm	d <sub>2</sub> mm	a mm			ID	10	32	5.85	80	11	30	6	4.9	3	5.1	● 111811	1/4	28	7.52	90	12.5	35	8	6.2	3	6.65	● 111812	5/16	24	9.31	90	12.5	35	9	7	3	8.2	● 111824															
Ø" d <sub>1</sub> EG UNF	P TPI	d <sub>1</sub> mm	l <sub>1</sub> mm	l <sub>2</sub> mm	l <sub>3</sub> mm	d <sub>2</sub> mm	a mm			ID																																																										
10	32	5.85	80	11	30	6	4.9	3	5.1	● 111811																																																										
1/4	28	7.52	90	12.5	35	8	6.2	3	6.65	● 111812																																																										
5/16	24	9.31	90	12.5	35	9	7	3	8.2	● 111824																																																										
<table border="1"> <thead> <tr> <th>Ø" d<sub>1</sub> EG UNF</th> <th>P TPI</th> <th>d<sub>1</sub> mm</th> <th>l<sub>1</sub> mm</th> <th>l<sub>2</sub> mm</th> <th>l<sub>3</sub> mm</th> <th>d<sub>2</sub> mm</th> <th>a mm</th> <th></th> <th></th> <th>ID</th> </tr> </thead> <tbody> <tr> <td>10</td> <td>32</td> <td>5.85</td> <td>80</td> <td>20</td> <td></td> <td>6</td> <td>4.9</td> <td>3</td> <td>5.1</td> <td>● 149702</td> </tr> <tr> <td>1/4</td> <td>28</td> <td>7.52</td> <td>90</td> <td>25</td> <td></td> <td>8</td> <td>6.2</td> <td>3</td> <td>6.65</td> <td>● 149724</td> </tr> </tbody> </table>										Ø" d <sub>1</sub> EG UNF	P TPI	d <sub>1</sub> mm	l <sub>1</sub> mm	l <sub>2</sub> mm	l <sub>3</sub> mm	d <sub>2</sub> mm	a mm			ID	10	32	5.85	80	20		6	4.9	3	5.1	● 149702	1/4	28	7.52	90	25		8	6.2	3	6.65	● 149724																										
Ø" d <sub>1</sub> EG UNF	P TPI	d <sub>1</sub> mm	l <sub>1</sub> mm	l <sub>2</sub> mm	l <sub>3</sub> mm	d <sub>2</sub> mm	a mm			ID																																																										
10	32	5.85	80	20		6	4.9	3	5.1	● 149702																																																										
1/4	28	7.52	90	25		8	6.2	3	6.65	● 149724																																																										



PM

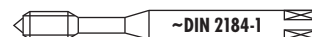

## aero

SA320-4



15 16 52 64

SA350-3



15 16 52 64

TL351VS-3



41 42

SA320-4

SA350-3

TL351VS-3



< 1.5 x D

< 2 x D



< 2 x D

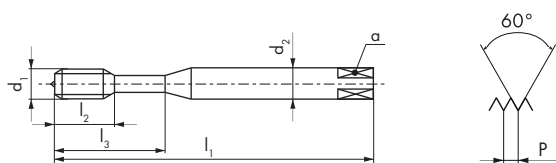

4 x P

2.5 x P

2.5 x P



3B

3B

3B

Ø" d <sub>1</sub> EG UNF	P TPI	d <sub>1</sub> mm	l <sub>1</sub> mm	l <sub>2</sub> mm	l <sub>3</sub> mm	d <sub>2</sub> mm	a mm		
10	32	5.85	80	15	23	6	4.9	3	5.1
1/4	28	7.52	90	18	29	8	6.2	3	6.65
5/16	24	9.31	90	20	31	9	7	3	8.2

ID	ID	ID
● 149190	● 149192	● 148008
● 146099	● 149268	● 148014
● 149336	● 149338	● 148021

## Allgemeines

Der DC-Kronengewindebohrer mit "V"-Oberflächenbehandlung ist ein Hochleistungswerkzeug, das eine sichere Toleranzhaltigkeit und eine sehr saubere Oberflächenqualität garantiert.

## Anwendungsbereich

Dank der stirnseitigen Aussparung, die die Spanaufnahme erlaubt, kann der Kronengewindebohrer sowohl für das Schneiden von Durchgangs- als auch von Sacklöchern verwendet werden. Er ist bestimmt für die Bearbeitung von Werkstoffen mit einer Zugfestigkeit von bis zu 850 N/mm<sup>2</sup> und einer Bruchdehnung von maximal 30 %.

## Einsatz

Für einwandfreie Sacklochgewinde muss die Tiefe der Kernlochbohrung jeweils entsprechend angepasst und die nachstehenden Hinweise müssen befolgt werden:

- Gewinde schneiden, bis Rutschkupplung anspricht
- Gewindebohrer zurückdrehen und Späne entfernen
- Gewinde fertig schneiden.

## Spezielle Anforderungen

Das einwandfreie Funktionieren der DC-Kronengewindebohrer und der damit erzielten Gewindequalität ist abhängig von folgenden Voraussetzungen:

- Zentrierfehler darf 0.1 mm nicht überschreiten
- Einsatz eines entsprechenden Gewindeschneidfutters, das einen einwandfreien Rundlauf ermöglicht
- korrekte Schnittgeschwindigkeit wählen
- Schneidöl dem Werkstoff anpassen
- einspannen in einem Gewindeschneidfutter mit Längenausgleich und Überlastungskupplung
- Überlastungskupplung so einstellen, dass das Ansprechdrehmoment nur leicht höher liegt als das Schneiddrehmoment.

Es ist empfehlenswert, beim ersten Gewinde die Rutschkupplung bis zum Gleiten zu entlasten und dann schrittweise anzuziehen, bis der Gewindebohrer mitgenommen wird.

## Spanaufnahme

Die Spanaufnahmekapazität der stirnseitigen Krone ist ausreichend für:

Gewindedurchmesser	Ø 20 - 29 mm	≥ Ø 30 mm
M	-	1.4 x D
MF	1.2 x D	1.4 x D
UN-8	-	1.4 x D
G	1.2 x D	1.4 x D

## General information

The DC crown tap with "V" surface treatment to prevent cold welding is a tool of high performance, which offers a very high quality surface finish of the tapped threads.

## Application rang

Thanks to the front recess providing space for the chip collection, the DC crown tap is suitable for both, through and blind hole tapping. The crown tap can be used for materials with a tensile strength up to 850 N/mm<sup>2</sup> and an elongation of maximum 30 %.

## Utilization

For an optimal blind hole threading, the core hole depth must be adapted accordingly and the following application instructions must be followed:

- tap until tapping head clutch slips
- retract tap and clear chips
- tap to the full depth.

## General hints

The efficient operation of DC crown taps, as well as the quality of the cut threads, depend on observation of the following rules:

- do not exceed the maximum permissible centering error of 0.1 mm
- the tap must run concentrically, use a suitable tapping head
- tap at the correct cutting speed
- select a coolant to suit the material being tapped
- use a tapping head with axial compensation and safety clutch
- set the safety clutch so that it will slip at just above the tapping torque.

When tapping the first hole, slacken the clutch until it slips, then gradually tighten it until the tap is driven.

## Chip accumulation

The chip accumulation capacity of the recess is the following:

Thread diameter	Ø 20 - 29 mm	≥ Ø 30 mm
M	-	1.4 x D
MF	1.2 x D	1.4 x D
UN-8	-	1.4 x D
G	1.2 x D	1.4 x D

## Schnittgeschwindigkeiten und Drehzahlen (Richtwerte) - Cutting and spindle speeds (guide values)

M	P	V <sub>c</sub> (m/min)	n <sup>n</sup> (U/min)	MF	P	V <sub>c</sub> (m/min)	n <sup>n</sup> (U/min)	MF	P	V <sub>c</sub> (m/min)	n <sup>n</sup> (U/min)	UN-8	P	V <sub>c</sub> (m/min)	n <sup>n</sup> (U/min)
30	3.5	7.9	84	22	1.5	8.0	116	45	1.5	6.9	49	1 1/4"	8	7.8	77
33	3.5	7.7	74	24	1.5	8.0	106	45	2.0	6.9	49	1 3/8"	8	7.6	69
36	4.0	7.5	66	26	1.5	7.9	97	48	1.5	6.6	44	1 1/2"	8	7.3	62
39	4.0	7.3	60	28	1.5	7.9	90	48	2.0	6.6	44	1 5/8"	8	7.1	55
42	4.5	7.1	54	30	1.5	7.9	84	48	3.0	6.6	44	1 3/4"	8	6.9	49
45	4.5	6.9	49	30	2.0	7.9	84	48	4.0	6.6	44	1 7/8"	8	6.7	45
48	5.0	6.6	44	32	1.5	7.8	77	50	1.5	6.5	41	2"	8	6.4	40
52	5.0	6.4	39	32	2.0	7.8	77	52	1.5	6.4	39	2 1/8"	8	6.4	38
56	5.5	6.1	35	33	1.5	7.7	74	52	3.0	6.4	39	2 1/4"	8	6.1	34
60	5.5	5.8	31	33	2.0	7.7	74	55	1.5	6.2	36	2 1/2"	8	5.6	28
64	6.0	5.5	28	34	1.5	7.6	71	56	4.0	6.1	35				
68	6.0	5.2	25	35	1.5	7.6	69	60	2.0	5.8	31				
				36	1.5	7.5	66	64	4.0	5.5	28				
				36	2.0	7.5	66	68	4.0	5.2	25				
				36	3.0	7.5	66	72	6.0	5.0	22				
				38	1.5	7.3	62	76	6.0	4.7	20				
				40	1.5	7.2	57	80	2.0	4.4	18				
				40	2.0	7.2	57	80	4.0	4.4	18				
				42	1.5	7.1	54	80	6.0	4.4	18				
				42	2.0	7.1	54	90	6.0	3.7	13				
				42	3.0	7.1	54	100	6.0	3.0	10				
				42	4.0	7.1	54	110	6.0	2.5	7				
												<b>G</b>	<b>P</b>	<b>V<sub>c</sub></b>	<b>n</b>
													TPI	(m/min)	(U/min)
												3/4"	14	7.9	95
												1"	11	7.7	74
												1 1/4"	11	7.1	54
												1 1/2"	11	6.6	44
												1 3/4"	11	6.3	37
												2"	11	5.8	31

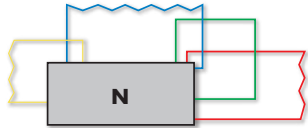



N470V-4

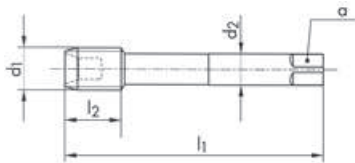

11 12 13 14 21 32

N470V-4



$\emptyset d_1$ M	P mm	$l_1$ mm	$l_2$ mm	$d_2$ mm	a mm			ID
30	3.5	180	39	22	18	5	26.5	● 102575
33	3.5	180	39	22	18	5	29.5	★ 102576
36	4	200	43	25	20	5	32	● 102577
39	4	200	43	25	20	5	35	● 102578
42	4.5	220	47	28	22	5	37.5	● 102579
45	4.5	220	47	28	22	5	40.5	● 102580
48	5	240	52	32	24	5	43	● 102581
52	5	240	52	32	24	5	47	● 102582
56	5.5	260	58	36	29	6	50.5	● 102583
60	5.5	260	58	36	29	6	54.5	● 102584
64	6	290	64	40	32	6	58	● 102585
68	6	290	64	40	32	6	62	★ 102586

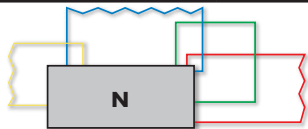

N470V-3



11 12 13 14 21 32

N470V-3

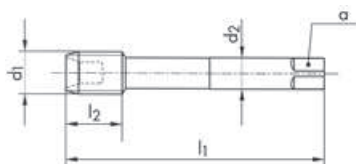

Ø d <sub>1</sub> MF	P mm	l <sub>1</sub> mm	l <sub>2</sub> mm	d <sub>2</sub> mm	a mm			ID
△22	1.5	125	28	18	14.5	4	20.5	* 102526
△26	1.5	140	30	18	14.5	4	24.5	* 102529
△28	1.5	140	30	20	16	4	26.5	* 102530
30	1.5	160	32	22	18	5	28.5	* 102531
34	1.5	160	26	22	18	5	32.5	* 102537
35	1.5	175	28	25	20	5	33.5	* 102538
36	2	175	35	25	20	5	34	● 102540
36	3	200	43	25	20	5	33	● 102541
38	1.5	175	28	25	20	5	36.5	* 102542
40	2	190	38	28	22	5	38	* 102544
42	2	190	38	28	22	5	40	● 102546
42	3	220	47	28	22	5	39	● 102547
48	1.5	205	34	32	24	5	46.5	* 102551
48	3	205	41	32	24	5	45	● 102553
52	3	205	41	32	24	5	49	● 102557
56	4	260	58	36	29	6	52	● 102559
64	4	290	64	40	32	6	60	● 102561
80	4	270	56	45	35	7	76	* 102564



Other sizes from Ø 30 to 160 mm on request!



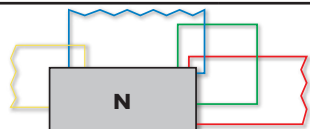



N470V-3



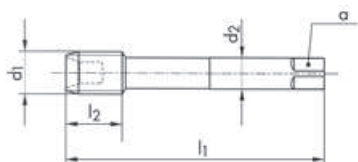

11 12 13 14 21 32

N470V-3

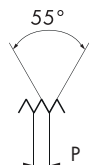
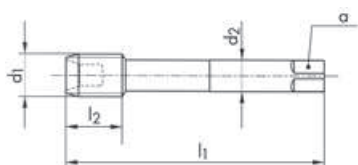

$\emptyset'' d_1$ UN	P TPI	$d_1$ mm	$l_1$ mm	$l_2$ mm	$d_2$ mm	$\alpha$ mm			ID
1 1/4	8	31.75	180	39	22	18	5	28.7	● 102566
1 3/8	8	34.92	180	39	22	18	5	31.8	● 102568
1 1/2	8	38.1	200	43	25	20	5	35	● 102565
1 5/8	8	41.27	220	47	28	22	5	38.2	● 102569
1 3/4	8	44.45	220	47	28	22	5	41.4	● 102567
1 7/8	8	47.62	240	52	32	24	5	44.5	● 102570
2	8	50.8	205	41	32	24	5	47.7	● 102572
2 1/8	8	53.97	205	41	32	24	5	50.9	★ 143542
2 1/4	8	57.15	220	45	36	29	6	54.1	● 102571
2 1/2	8	63.5	220	45	36	29	6	60.4	● 111879



$\emptyset'' d_1$ G	P TPI	$d_1$ mm	$l_1$ mm	$l_2$ mm	$d_2$ mm	$\alpha$ mm			ID
$\Delta$ 3/4	14	26.44	150	34	20	16	4	24.4	● 102525
1	11	33.24	160	32	22	18	5	30.7	● 102522
1 1/4	11	41.91	190	38	28	22	5	39.3	● 102519
1 1/2	11	47.8	205	41	32	24	5	45.2	● 102518
1 3/4	11	53.74	205	41	32	24	5	51.2	★ 102520
2	11	59.61	220	45	36	29	6	57	● 102524



# KOMBI-GEWINDEBOHRER

## Allgemeines

Der DC-Kombi-Gewindebohrer ist ein Werkzeug, das das Schneiden des Kernloches und des Gewindes in einem Arbeitsgang erlaubt, ohne dass ein Werkzeugwechsel notwendig ist.

Er ist ideal für den Einsatz auf CNC-Maschinen, Bohrtasteinheiten, Drehbänken mit Revolverkopf und Gewindeschneidmaschinen.

## Anwendungsbereich

Werkstoffe mit einer Zugfestigkeit bis 750 N/mm<sup>2</sup> lassen sich mit dem DC-Kombi-Gewindebohrer bearbeiten, also gewisse Stähle, Grauguss, Messing, Aluminium.

## Spezielle Anforderungen

- Das Kernloch muss vollständig durchbohrt sein, bevor der Gewindebohrer zu schneiden beginnt.
- Bei der Bearbeitung von kurzspanenden Werkstoffen darf die Gewindetiefe 1.8 x D nicht überschreiten (Typ N5952 bis 2 x D).
- Bei der Bearbeitung von langspanenden Werkstoffen darf die Gewindetiefe 1.2 x D nicht überschreiten.
- Schmieren wie beim Gewindeschneiden.

## Schnittgeschwindigkeiten

Wenn die Maschine, auf der die Kombiboher eingesetzt werden, es erlaubt, ist es vorteilhaft, die idealste Drehzahl für das Gewindeschneiden zu wählen. (Siehe dazu unsere Anwendungstabelle).

Für Maschinen, auf denen eine unterschiedliche Drehzahl für das Bohren und Gewindeschneiden nicht eingestellt werden kann, empfehlen wir die nachstehend aufgeführten Schnittwerte.

## Programmierungs-Instruktionen

### Ansenkung:

Gleichzeitig zentrieren und ansenken.

### Programmschritte bei Spindelvorschub und Rotation, 100 % synchronisiert (Idealfall):

- 1) Kombi-Gewindebohrer im Eilgang in Arbeitsposition bringen
- 2) Bohren:
  - Drehzahl einstellen
  - Vorschub einstellen
  - lange Späne vermeiden
  - Späne entfernen
- 3) Gewindeanschnitt in Startposition bringen
- 4) Gewindeschneiden:
  - Drehzahl einstellen
  - Vorschub (100 %) einstellen
  - Gewindetiefe einstellen
  - Gewindebohrer muss vor Arbeitsbeginn spanfrei sein
- 5) Kombi-Gewindebohrer zurück in Startposition.

### Programmschritte bei nicht voller Synchronisation von Spindelvorschub und Rotation:

Wichtig: Kombi-Gewindebohrer in Futter spannen, mit blockierter Andrucksfeder, jedoch mit Längenausgleich.

- 1) Kombi-Gewindebohrer im Eilgang in Arbeitsposition bringen
- 2) Bohren:
  - Drehzahl einstellen
  - Vorschub einstellen
  - lange Späne vermeiden
  - Späne entfernen
- 3) Gewindeanschnitt in Startposition bringen
- 4) Gewindeschneiden:
  - Drehzahl einstellen
  - Vorschub = 90 - 95 %
  - Gewindetiefe einstellen
- 5) Kombi-Gewindebohrer zurück in Startposition.

## Schnittgeschwindigkeiten und Drehzahlen (Richtwerte)

Werkstoffgruppen	Vc (m/min)	Durchmesser und Drehzahl U/min										
		M3	M4	M5	M6	M8	M10	M12	M14	M16	M18	M20
Stähle bis 500 N/mm <sup>2</sup>	20	2120	1600	1270	1060	800	640	530	460	400	360	320
Stähle über 500 N/mm <sup>2</sup>	15	1600	1200	950	800	600	480	400	340	300	270	240
Grauguss weich	20	2120	1600	1270	1060	800	640	530	460	400	360	320
Grauguss hart	15	1600	1200	950	800	600	480	400	340	300	270	240
Messing	25	2650	2000	1600	1330	950	800	660	570	500	450	400
Aluminium	25	2650	2000	1600	1330	950	800	660	570	500	450	400



# COMBINATION DRILL/TAPS

## General information

DC combination drill/taps - two tools in one, which allows the drilling and the threading of a workpiece without changing the tool.

It is the optimal solution for CNC-machines, drilling heads, turret lathes and tapping machines.

## Application rang

DC combination drill/taps are recommended for use in materials with a tensile strenght up to 750 N/mm<sup>2</sup>, such as certain steels, cast iron, aluminium, brass.

## General hints

- The core hole must be completely drilled through before the tap starts cutting.
- In short chipping materials, the depth of thread should not exceed 1.8 x D (type N5952 up to 2 x D).
- In long chipping materials, the depth of thread should not exceed 1.2 x D.
- Lubricate as for tapping.

## Cutting speeds

On drilling heads and CNC-machines, the ideal speeds for drilling and tapping are selected (see our application chart).

If the same speed is selected for both drilling and tapping, we recommend the values indicated below.

## Programming instructions

### Countersinking:

Center and countersink simultaneously.

### Programming steps for spindle feed and rotation 100 % synchronised (ideal case):

- 1) Combi-drill-tap in rapid to start position
- 2) Drilling:
  - set speed
  - set feed
  - avoid long chips
  - clear shavings
- 3) Tapping section in start position
- 4) Tapping:
  - set speed
  - feed = 100 % pitch
  - set thread depth
  - tap must be free of swarf before starting to cut
- 5) Combi-drill-tap returns to start position.

### Programming steps for spindle feed rotation not fully synchronised:

Important: Mount combination drill-tap in chuck with locked pressure spring, but with axial compensation on pull.

- 1) Combi-drill-tap in rapid to start position
- 2) Drilling:
  - set speed
  - set feed
  - avoid long chips
  - clear shavings
- 3) Tapping section in start position
- 4) Tapping:
  - set speed
  - feed = 90 - 95 % pitch
  - set thread depth
- 5) Combi-drill-tap returns to start position.

## Cutting and spindle speeds (guide values)

Material groups	Vc (m/min)	Speeds for different diameters										
		M3	M4	M5	M6	M8	M10	M12	M14	M16	M18	M20
Steels up to 500 N/mm <sup>2</sup>	20	2120	1600	1270	1060	800	640	530	460	400	360	320
Steels over 500 N/mm <sup>2</sup>	15	1600	1200	950	800	600	480	400	340	300	270	240
Cast iron, soft	20	2120	1600	1270	1060	800	640	530	460	400	360	320
Cast iron, hard	15	1600	1200	950	800	600	480	400	340	300	270	240
Brass	25	2650	2000	1600	1330	950	800	660	570	500	450	400
Aluminium	25	2650	2000	1600	1330	950	800	660	570	500	450	400

# M, MF ISO DIN 13

HSSE



								N5951	N5952	N5951				
N5951														
N5952														
N5951														
$\emptyset d_1$ M	P mm	$l_{11}$ mm	$l_2$ mm	$d_2$ mm	$a$ mm	$d_{10}$ mm	$l_{10}$ mm	ID						
3	0.5	62	12.5	3.5	2.7	2.55	9	● 104578						
4	0.7	66	16	4.5	3.4	3.36	10	● 104580						
5	0.8	75.5	18	6	4.9	4.26	12.5	● 104583						
6	1	81	20	6	4.9	5.05	14	● 104585						
8	1.25	93	12	6	4.9	6.8	20	● 104588						
10	1.5	99	14	7	5.5	8.55	22	● 104571						
12	1.75	106	16	9	7	10.3	25	● 104573						
16	2	123	20	12	9	14.1	32	● 104576						
20	2.5	132	22	16	12	17.6	36	● 104577						
$\emptyset d_1$ M	P mm	$l_{11}$ mm	$l_2$ mm	$d_2$ mm	$a$ mm	$d_{10}$ mm	$l_{10}$ mm	ID						
4	0.7	77	16	4.5	3.4	3.36	21	● 104608						
5	0.8	87	18	6	4.9	4.26	24	● 104609						
6	1	94	20	6	4.9	5.05	27	● 104610						
8	1.25	109	12	6	4.9	6.8	36	● 104611						
10	1.5	118	14	7	5.5	8.55	41	● 104603						
$\emptyset d_1$ MF	P mm	$l_{11}$ mm	$l_2$ mm	$d_2$ mm	$a$ mm	$d_{10}$ mm	$l_{10}$ mm	ID						
4	0.5	66	16	4.5	3.4	3.55	10	★ 104579						
5	0.75	75.5	18	6	4.9	4.31	12.5	★ 123379						
8	1	93	12	6	4.9	7.05	20	● 104587						
10	1	99	14	7	5.5	9.05	22	● 104570						
$\emptyset d_1$ MF	P mm	$l_{11}$ mm	$l_2$ mm	$d_2$ mm	$a$ mm	$d_{10}$ mm	$l_{10}$ mm	ID						
12	1.5	106	16	9	7	10.55	25	● 142825						
16	1.5	123	16	12	9	14.55	32	● 142826						
20	1.5	132	18	16	12	18.55	36	● 111844						
25	1.5	155	22	18	14.5	23.55	45	● 111845						
32	1.5	170	24	22	18	30.55	50	● 111846						



N5951



N5951



2B

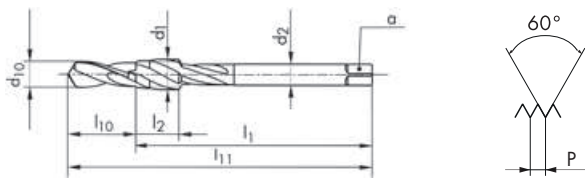

$\emptyset'' d_1$ UNC	P TPI	$d_1$ mm	$l_{11}$ mm	$l_2$ mm	$d_2$ mm	a mm	$d_{10}$ mm	$l_{10}$ mm
6	32	3.5	66	16	4	3	2.8	10
10	24	4.82	75.5	18	4.5	3.4	3.86	12.5
1/4	20	6.35	81	20	7	5.5	5.15	14
1/2	13	12.7	106	16	9	7	10.85	25

ID

- ★ 104601
- 104598
- 104597
- ★ 104596

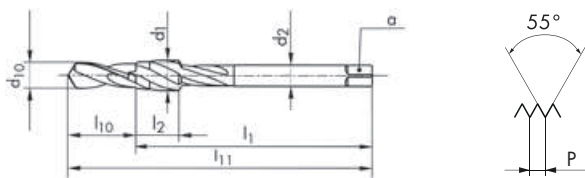

$\emptyset'' d_1$ G	P TPI	$d_1$ mm	$l_{11}$ mm	$l_2$ mm	$d_2$ mm	a mm	$d_{10}$ mm	$l_{10}$ mm
1/8	28	9.72	93	12	7	5.5	8.75	20
1/4	19	13.15	106	14	11	9	11.75	25
3/8	19	16.66	123	16	12	9	15.25	32
1/2	14	20.95	132	18	16	12	19	36

ID

- 104567
- 104566
- 104569
- 104565

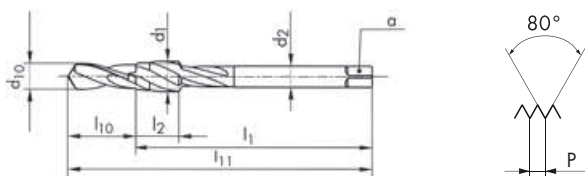

$\emptyset d_1$ PG	P TPI	$d_1$ mm	$l_{11}$ mm	$l_2$ mm	$d_2$ mm	a mm	$d_{10}$ mm	$l_{10}$ mm
16	18	22.5	142	20	18	14.5	21.25	40
29	16	37	203	28	28	22	35.65	63

ID

- 104591
- 104593

# **GEWINDEFORMEN**

# **THREAD FORMING**

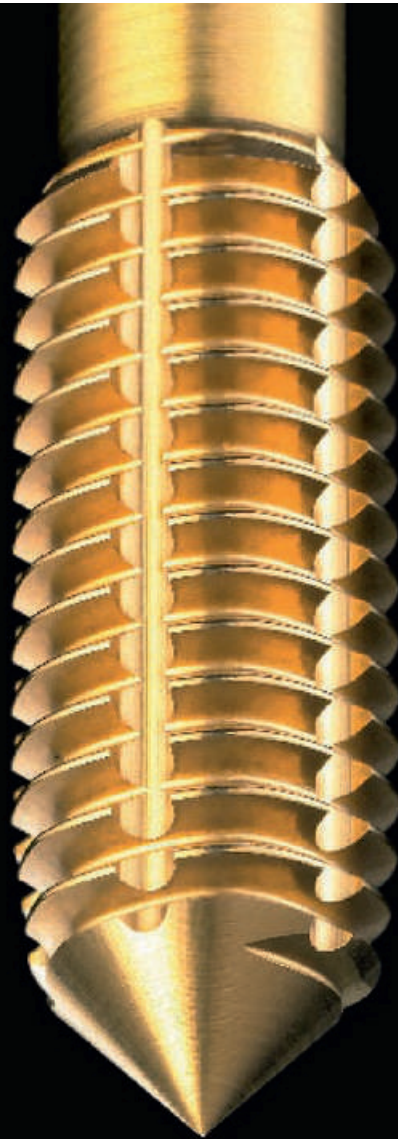

## **AUF ANFRAGE**

*Spezialanfertigungen mit angepassten Polygonformen für spezifische Bearbeitungsfälle.*

## **ON REQUEST**

*Special executions with adapted polygon lobes for specific applications.*

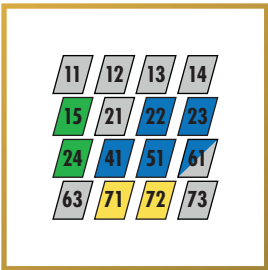

### Anwendungsbereich

Für sämtliche kaltverformbaren Werkstoffe mit einer Bruchdehnung von mindestens 10 % und einer Zugfestigkeit von bis zu 1'150 N/mm<sup>2</sup>, z.B. Stähle, rostfreie Stähle, Reintitan, Aluminium, Kupfer, langspannendes Messing, usw.

### Range of application

All materials with a minimum of 10 % elongation and a tensile strength of up to 1'150 N/mm<sup>2</sup>, e.g. steels, stainless steels, pure titanium, aluminium, copper, long chipping brass, etc.

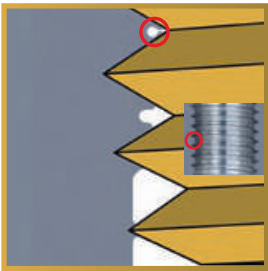

### Formprozess

Die Zahnspitzen und -flanken des Gewindeformers dringen in den verformbaren Werkstoff ein und verdrängen das Material in die Freiräume des Werkzeugprofils. Dadurch entsteht das Gewindeprofil mit der typischen Furche in der Spitze.

### Forming process

The polished points and flats of the thread former's teeth pierce the ductile material and force the material into the space in the tool profile. This creates the thread profile with its typical groove in the crest.



### Vorteile

- Höhere Prozesssicherheit, da keine Späne entstehen.
- Ein einziges Werkzeug für Durchgangs- und Sacklöcher.
- Ideal für tiefe Gewinde.
- Gewinde mit höherer Ausreissfestigkeit bei statischer und dynamischer Belastung.

### Advantages

- Higher process security due to the lack of shavings.
- Only one tool for both, through and blind holes.
- Optimal for deep threads.
- Thread with higher resistance of stripping by static and dynamic load.



### Einsatz einschränkung

Das Gewindeformen in dünnwandige Werkstücke ist aus physikalischer Sicht mit der notwendigen Sorgfalt anzuwenden.

### Application restriction

For physical reasons, thread forming in thin-walled workpieces should be carried out with due care.



### Ausreichend Schmieren

Beim Verformen von Werkstoffen entstehen erhebliche Reibkräfte. Deshalb muss das Werkzeug stets durch einen Schmierfilm geschützt werden. Ein Riss des Schmierfilms verursacht schnell Kaltverschweißungen, die zum Werkzeugbruch führen können.

### Adequate lubrication

The thread forming process generates considerable friction. Therefore the tool must be protected by a film of lubricant. If the supply of lubricant is interrupted, then cold welding will quickly occur, resulting in tool failure.

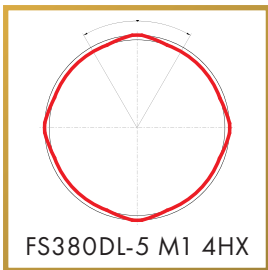

FS380DL-5 M1 4HX

#### **Gewindeformer FS-DL**

Universalgewindeformer mit 4 Druckstellen für kleine Gewinde im Abmessungsbereich  $\varnothing \geq 1 - < 3$  mm in alle kaltverformbaren Werkstoffe. Mit "DLC"-Verschleisschutzschicht mit ausserordentlichen Gleit- und Schmiereigenschaften. Für rostfreie Stähle, Reinkupfer, usw.

#### **Thread former FS-DL**

Universal thread former with 4 forming lobes for small thread sizes  $\varnothing \geq 1 - < 3$  mm, in all cold forming materials. With "DLC" wear-protective coating with excellent lubrication and sliding properties. For stainless steels, pure copper, etc.

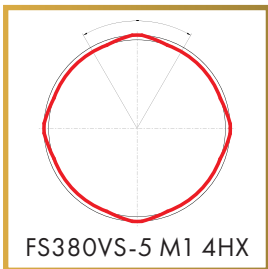

FS380VS-5 M1 4HX

#### **Gewindeformer FS-VS**

Universalgewindeformer mit 4 Druckstellen für kleine Gewinde im Abmessungsbereich  $\varnothing \geq 1 - < 3$  mm in alle kaltverformbaren Werkstoffe. Mit DC-"VS"-Gleit- und Verschleisschutzschicht.

#### **Thread former FS-VS**

Universal thread former with 4 forming lobes for small thread sizes  $\varnothing \geq 1 - < 3$  mm, in all cold forming materials. With DC "VS" tool wear protective coating with high sliding properties.

**NEW**

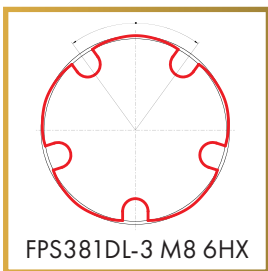

FPS381DL-3 M8 6HX

#### **Gewindeformer FPS-DL**

Für  $\varnothing \geq 3$  mm, mit breiten Druckstellen, die bei abrasiven Werkstoffen ein progressives Fließen verursachen. Mit "DLC"-Verschleisschutzschicht für besseres Gleiten und höhere Standzeiten in langspannendem Messing und Aluminium.

#### **Thread former FPS-DL**

For  $\varnothing \geq 3$  mm, with large forming lobes designed for a progressive flow of abrasive materials. With "DLC" wear-protective coating for better gliding and high tool life in long chipping brass and aluminium.

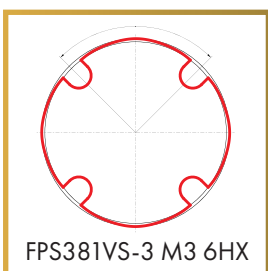

FPS381VS-3 M3 6HX

#### **Gewindeformer FPS-VS**

Für  $\varnothing \geq 3$  mm, mit breiten Druckstellen, für ein progressives Fließen von Werkstoffen mit geringer Bruchdehnung. Mit DC-"VS"-Verschleisschutzschicht mit thermischer und chemischer Beständigkeit bei hohen Temperaturen. Für Baustähle, Kohlenstoffstähle, legierte Stähle, usw.

#### **Thread former FPS-VS**

For  $\varnothing \geq 3$  mm, with large forming lobes designed for a progressive flow of materials with low elongation coefficient. With DC "VS" wear-protective coating with thermal and chemical properties. For structural steels, carbon steels, alloy steels, etc.

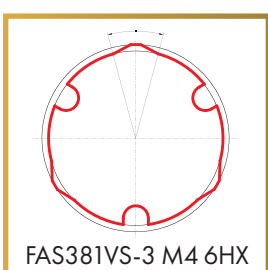

FAS381VS-3 M4 6HX

#### **Gewindeformer FAS-VS**

Für  $\varnothing \geq 3$  mm, mit spitzen Druckstellen, für ein schnelles Fließen von zähen Werkstoffen mit hoher Bruchdehnung. Mit DC-"VS"- Verschleisschutzschicht mit ausserordentlichen Gleit- und Schmiereigenschaften. Für rostfreie Stähle, Reinkupfer, usw.

#### **Thread former FAS-VS**

For  $\varnothing \geq 3$  mm, with pointed forming lobes designed for a fast flow of tough materials with high elongation coefficient. With DC "VS" wear-protective coating with excellent lubrication and sliding properties. For stainless steels, pure copper, etc.



### **Schmiernuten ab Ø 3 mm**

Dank dieser Nuten wird der Schmierstoff besser zur Werkzeugoberfläche geführt, die mit dem Werkstoff in direktem Kontakt ist.

### **Lubrication grooves from Ø 3 mm**

Lubricant will be guided to the surface of the tool which is directly in contact with the material.



### **Ohne Schmiernuten**

Besonders geeignet für die Bearbeitung von weichen Werkstoffen und für Durchgangslöcher in dünne Bleche.

### **Without lubrication grooves**

Especially recommended for forming soft materials and for through holes in thin parts (e.g. for sheet metal working).



### **Mit Innenkühlung**

Speziell empfohlen für tiefere Gewinde und für die Horizontalbearbeitung.

### **With internal coolant supply**

Highly recommended for deeper threads and for horizontal working.

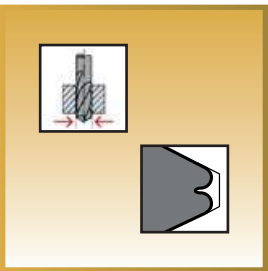

### **Korrektes Gewindeprofil**

Für das Verformen ist eine genaue, saubere Vorbohrung erforderlich, damit ein normgerechtes Gewinde entsteht. Bei Werkstoffen mit sehr hoher Bruchdehnung oder bei Gewindetiefen von  $> 2 \times D$  empfehlen wir, den Vorbohrungs-Ø um 0.02 bis 0.05 mm zu vergrößern.

### **Correct thread profile**

Accurate core hole is required in order to form a thread according to the norm. For materials with a very high elongation coefficient and threading depth  $> 2 \times D$ , we recommend increasing the core hole Ø by 0.02 to 0.05 mm.

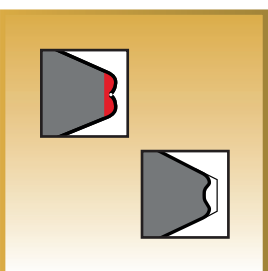

### **Unkorrektes Gewindeprofil**

Profil zu gross zufolge eines zu kleinen Vorbohrungsdurchmessers; verursacht ein zu hohes Drehmoment.

Profil ungenügend - Folge eines zu grossen Vorbohrungsdurchmessers.

### **Incorrect thread profile**

Too big profile due to the too small core hole diameter. The required torque is higher.

Incomplete profile caused by the core hole diameter being too big.



# KODIERUNG – CODIFICATION

**DC**-Gewindeformer

**DC** Thread formers

Beispiel - Example



Standard Polygonform <math>\lt; \varnothing 3 \text{ mm}</math>	Standard polygon form <math>\lt; \varnothing 3 \text{ mm}</math>	<b>FS</b>					
Passive Polygonform >math>\geq \varnothing 3 \text{ mm}</math>	Passive polygon form >math>\geq \varnothing 3 \text{ mm}</math>	<b>FPS</b>					
Aktive Polygonform >math>\geq \varnothing 3 \text{ mm}</math>	Active polygon form >math>\geq \varnothing 3 \text{ mm}</math>	<b>FAS</b>					
Spezialausführung	Special execution		<b>3</b>				
Langer DIN-Schaft verstärkt	DIN long - reinforced shank			<b>3</b>			
Langer DIN-Schaft durchfallend	DIN long - reduced shank			<b>4</b>			
Extra-langer DIN-Schaft verstärkt	DIN extra-long - reinforced shank			<b>5</b>			
Extra-langer DIN-Schaft durchfallend	DIN extra-long - reduced shank			<b>6</b>			
Gewindeformer	Thread former				<b>8</b>		
Ohne Schmiernuten	Without lubrication grooves					<b>0</b>	
Mit Schmiernuten	With lubrication grooves					<b>1</b>	
Innenkühlung mit seitlichem Austritt	Internal coolant with radial outflow					<b>4</b>	
Verschleisschutzschicht	VS wear-protective coating, general						<b>VS</b>
DLC-Beschichtung	DLC-coating						<b>DL</b>
2 - 3 Gewindegänge	2 - 3 chamfered threads						<b>-3</b>
1.5 - 2 Gewindegänge	1.5 - 2 chamfered threads						<b>-5</b>



# PIKTOGRAMME — PICTOGRAPHS



Für Werkstoffgruppen gemäss **DC**-Anwendungstabelle  
For material groups as per **DC** application chart

12	
1.0037	Si37-2 (S235JR)
1.0050	St50-2 (E295)
1.0060	St60-2 (E335)
1.5919	15CrNi6
1.7131	16MnCr5

22	
1.4301	X5CrNi18-10
1.4406	X2CrNiMoN17-12-2
1.4435	X2CrNiMo18-14-3
1.4541	X6CrNiTi18-10
1.4571	X6CrNiMoTi17-12-2

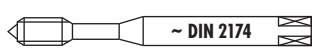

Verstärkter Schaft gemäss ~ DIN 2174  
Reinforced shank as per ~ DIN 2174

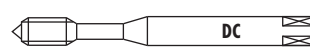

Verstärkter Schaft gemäss DC-Werksnorm  
Reinforced shank as per DC standards



Durchfallender Schaft gemäss ~ DIN 2174  
Reduced shank as per ~ DIN 2174



Durchfallender Schaft gemäss DC-Werksnorm  
Reduced shank as per DC standards



Extra-lang  
Extra-long



HSSE-PM  
HSSE-PM



Gewindeformer  
Thread former



Gewindeformer mit Schmiernuten  
Thread former with lubrication grooves



Innenkühlung mit stirnseitigem Schmiermittelaustritt, auf Anfrage  
Internal coolant with frontal outflow, on request



Innenkühlung mit seitlichem Schmiermittelaustritt, neu 45°  
**Umstellung auf neue Ausführung im Gange**  
Internal coolant with radial outflow, new 45°  
**Change to new version in progress**



Kernlochdurchmesser  
Core hole diameter



Linksgewinde auf Anfrage  
Left-hand thread on request



2 - 3 Gewindegänge, Form C  
2 - 3 chamfered threads, form C



1.5 - 2 Gewindegänge, Form E  
1.5 - 2 chamfered threads, form E



Toleranzklasse ISO 2 6HX  
Tolerance class ISO 2 6HX



Toleranzklasse ISO 3 6GX  
Tolerance class ISO 3 6GX



Durchgangs- und Sacklöcher < 1 x D  
Through / blind holes < 1 x D



Durchgangs- und Sacklöcher < 1.5 x D  
Through / blind holes < 1.5 x D



Durchgangs- und Sacklöcher < 2.5 x D  
Through / blind holes < 2.5 x D



Durchgangs- und Sacklöcher > 2.5 x D  
Through / blind holes > 2.5 x D



Durchgangs- und Sacklöcher < 3 x D  
Through / blind holes < 3 x D



DLC-Beschichtung  
DLC-coating



DC-\"VS\"-Verschleisschutzschicht für den allgemeinen Einsatz  
DC \"VS\" wear-protective coating for general use



Für synchrones Gewindeschneiden  
For Rigid Tapping



Für klassisches Gewindeschneiden  
For Classic Tapping



Lagerartikel  
Stock item



Kurzfristig lieferbar  
Available at short notice



Ab Lager lieferbar solange Vorrat  
Available from stock, while stock lasts

# ANWENDUNGSTABELLE — APPLICATION CHART

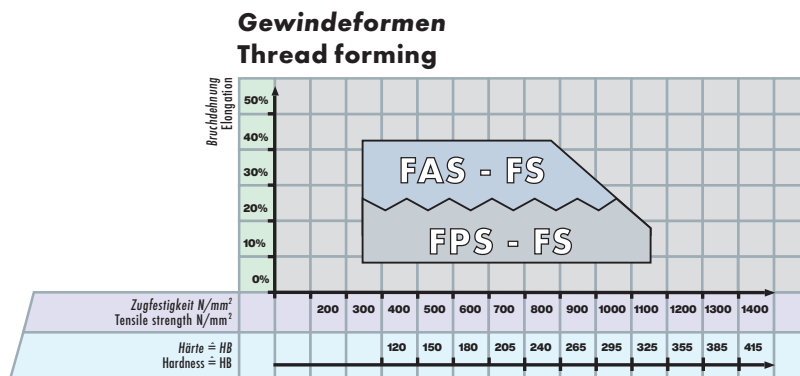

## DC -Anwendungsgruppen

## DC Material classification

Werkstoff-Gruppen Material groups	Werkstoffbezeichnung	Material designation	Härte Hardness (HB)	Festigkeit Tensile strength R <sub>m</sub> (N/mm <sup>2</sup> )	Dehnung Elongation A (%)
<b>10</b> Stahl Steels	11 Automatenstahl	Free-cutting steels	< 200	< 700	< 10
	12 Baustahl, Einsatzstahl	Structural, cementation steels	< 200	< 700	< 30
	13 Kohlenstoffstahl	Carbon steels	< 300	< 1000	< 20
	14 Stahl legiert < 850 N/mm <sup>2</sup>	Alloy steels < 850 N/mm <sup>2</sup>	< 250	< 850	< 30
	15 Stahl legiert / vergütet > 850 - < 1150 N/mm <sup>2</sup>	Alloy steels hard. / temp. > 850 - < 1150 N/mm <sup>2</sup>	> 250	> 850	< 30
	16 Hochfester Stahl ≤ 44 HRC	High tensile alloy steels ≤ 44 HRC	> 250	> 850	< 12
	17 Stahl vergütet > 44 - ≤ 54 HRC	Alloy steels tempered > 44 - ≤ 54 HRC	> 410	> 1400	< 2
	18 Stahl gehärtet > 54 - ≤ 63 HRC	Alloy steels hardened > 54 - ≤ 63 HRC	> 560	> 1980	< 2
<b>20</b> Rostfreier Stahl Stainless steels	21 Rostfreier Stahl, geschwefelt	Free machining stainless steels	< 250	< 850	< 25
	22 Austenitisch	Austenitic stainless steels	< 250	< 850	> 20
	23 Ferritisch, martensitisch < 850 N/mm <sup>2</sup>	Ferritic and martensitic < 850 N/mm <sup>2</sup>	< 250	< 850	> 20
	24 Ferritisch, martensitisch > 850 - < 1150 N/mm <sup>2</sup>	Ferritic and martensitic > 850 - < 1150 N/mm <sup>2</sup>	> 250	> 850	> 15
<b>30</b> Guss Cast iron	31 Grauguss	Cast iron	< 250	< 850	< 10
	32 Kugelgraphitguss, Temperguss	Spheroidal graphite + malleable cast iron	< 250	< 850	> 10
<b>40</b> Titan Titanium	41 Reintitan	Pure titanium	< 250	< 850	> 20
	42 Titanlegierung	Titanium alloys	> 250	> 850	< 20
<b>50</b> Nickel Nickel	51 Nickellegierung 1 ≤ 850 N/mm <sup>2</sup>	Nickel alloys 1 ≤ 850 N/mm <sup>2</sup>	< 250	< 850	> 25
	52 Nickellegierung 2 > 850 - ≤ 1150 N/mm <sup>2</sup>	Nickel alloys 2 > 850 - ≤ 1150 N/mm <sup>2</sup>	> 250	> 850	< 25
	53 Nickellegierung 3 > 1150 - ≤ 1600 N/mm <sup>2</sup>	Nickel alloys 3 > 1150 - ≤ 1600 N/mm <sup>2</sup>	> 340	> 1150	< 20
<b>60</b> Kupfer Copper	61 Reinkupfer (Elektrolytkupfer)	Pure copper (electrolytic copper)	< 120	< 400	> 12
	62 Messing, Bronze, Rotguss (kurzspanend)	Short chip brass, phosphor bronze, gun metal	< 200	< 700	< 12
	63 Messing (langspanend)	Long chip brass	< 200	< 700	> 12
	64 Messing bleifrei	Lead free brass	< 220	< 700	> 15
<b>70</b> Aluminium Magnesium Aluminium Magnesium	71 Al unlegiert	Al unalloyed	< 100	< 350	> 15
	72 Al legiert Si < 1.5 %	Al alloyed Si < 1.5 %	< 150	< 500	> 15
	73 Al legiert Si > 1.5 % - < 10 %	Al alloyed Si > 1.5 % - < 10 %	< 120	< 400	< 15
	74 Al legiert Si > 10 %, Mg-Legierungen	Al alloyed Si > 10 %, Mg-alloys	< 120	< 400	< 10
<b>80</b> Kunststoff Plastic compounds	81 Thermoplaste	Thermoplastics	-	-	-
	82 Duroplaste	Duroplastics	-	-	-
	83 Faserverstärkte Kunststoffe	Glass fibre reinforced plastics	-	-	-
<b>90</b> Edelmetalle Precious metals	91 Gelbgold	Yellow gold	-	-	-
	92 Rotgold	Red gold	-	-	-
	93 Weissgold	White gold	-	-	-
	94 Silber	Silver	-	-	-

Optimal mit Schneidöl  
Optimal with cutting oil

Geeignet mit Schneidöl  
Suitable with cutting oil

Optimal mit Emulsion  
Optimal with emulsion























Geeignet mit Emulsion  
Suitable with emulsion





					FS		FPS	
Merkmale Characteristics								
							<b>NEW</b>	
Lochart Hole type								
					<b>FS380VS-5</b> <b>FS380VS-3</b>	<b>FS380DL-5</b> <b>FS380DL-3</b>	<b>FPS380DL-3</b> <b>FPS381DL-3</b>	<b>FPS380VS-3</b> <b>FPS381VS-3</b>
<b>M</b>	6HX	ISO DIN 13	DIN lang DIN long	~DIN 2174	254	255	256	256
<b>M</b>	6GX	ISO DIN 13	DIN lang DIN long	~DIN 2174	254	255		256
<b>M</b>	6HX	ISO DIN 13	Extra-lang Extra-long	DC				
<b>MF</b>	6HX	ISO DIN 13	DIN lang DIN long	~DIN 2174				262
<b>UNC</b>	2BX	ASME B1.1	DIN lang DIN long	~DIN 2184-1	263			263
<b>UNF</b>	2BX	ASME B1.1	DIN lang DIN long	~DIN 2184-1	264			264
								<b>FPS481VS-3</b>
<b>M</b>	6HX	ISO DIN 13	DIN lang DIN long	~DIN 2174				257
<b>M</b>	6GX	ISO DIN 13	DIN lang DIN long	~DIN 2174				
<b>M</b>	6HX	ISO DIN 13	Extra-lang Extra-long	DC				
<b>MF</b>	6HX	ISO DIN 13	DIN lang DIN long	~DIN 2174				262
<b>UNC</b>	2BX	ASME B1.1	DIN lang DIN long	~DIN 2184-1				
<b>UNF</b>	2BX	ASME B1.1	DIN lang DIN long	~DIN 2184-1				
<b>G</b> (BSP)		DIN EN ISO 228	DIN lang DIN long	~DIN 2189				265



FPS			FAS			
 VS	 VS	 VS	  VS	 VS	 VS	 VS
			 			
						
<b>FPS384VS-3</b>	<b>FPS581VS-3</b>	<b>FPS584VS-3</b>	<b>FAS380VS-3</b> <b>FAS381VS-3</b>	<b>FAS384VS-3</b>	<b>FAS581VS-3</b>	<b>FAS584VS-3</b>
258			259	260		
			259			
	257	258			261	261
			262			
			263			
			264			
<b>FPS484VS-3</b>	<b>FPS681VS-3</b>	<b>FPS684VS-3</b>	<b>FAS481VS-3</b>	<b>FAS484VS-3</b>	<b>FAS681VS-3</b>	<b>FAS684VS-3</b>
258			259	260		
			259			
	257	258			261	261
			262			
			265			

# FS FORMING

**FS380VS-5**

11 12 13 14  
21
**FS380VS-3**

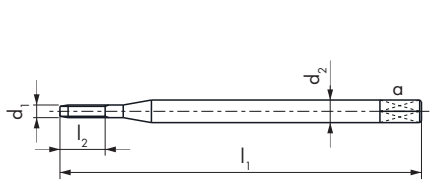
11 12 13 14  
21
**FS380VS-5**
**FS380VS-3**
**FS380VS-3**
**FS380VS-3**

**6HX**
**6HX**
**6HX**
**6GX**

$\emptyset d_1$ M	P mm	$l_1$ mm	$l_2$ mm	$d_2$ mm	a mm	$\frac{d_2}{P}$ 4HX Tol. 6HX	ID	ID	ID	ID 6H + mm
1	0.25	40	3	2.5		0.88 +0.02	● 157171	● 173452		
1.2	0.25	40	3.6	2.5		1.08 +0.02	● 157172	● 173455		
1.4	0.3	40	4.2	2.5		1.25 +0.02	● 157173	● 173458		
1.6	0.35	40	4.8	2.5		1.45 +0.02	● 157174	● 169779		
1.7	0.35	40	5.1	2.5		1.55 +0.02		● 169782		
1.8	0.35	40	5.4	2.5		1.65 +0.02	● 157175	● 169785		
2	0.4	45	8	2.8	2.1	1.8 +0.02			● 157176	● 157180 0.019
2.5	0.45	50	10	2.8	2.1	2.3 +0.02			● 157178	● 157181 0.020
2.6	0.45	50	10	2.8	2.1	2.4 +0.02			● 157179	

 $\leq M1.5$ 
**4HX**

# FS FORMING

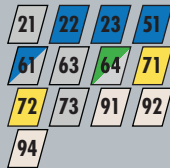
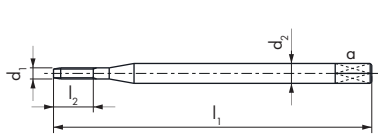
**FS380DL-5**

**FS380DL-3**

**FS380DL-5**
**FS380DL-3**
**FS380DL-3**
**FS380DL-3**

**6HX**
**6HX**
**6HX**
**6GX**

$\emptyset d_1$ M	P mm	$l_1$ mm	$l_2$ mm	$d_2$ mm	a mm	$\frac{d_2}{P}$ 4HX Tol. 6HX	ID	ID	ID	ID 6H + mm
1	0.25	40	3	2.5		0.88 +0.02	● 172839	● 173461		
1.2	0.25	40	3.6	2.5		1.08 +0.02	● 172840	● 173464		
1.4	0.3	40	4.2	2.5		1.25 +0.02	● 172841	● 173467		
1.6	0.35	40	4.8	2.5		1.45 +0.02	● 170585	● 170916		
1.7	0.35	40	5.1	2.5		1.55 +0.02		● 172843		
1.8	0.35	40	5.4	2.5		1.65 +0.02	● 172842	● 172844		
2	0.4	45	8	2.8	2.1	1.8 +0.02			● 158814	● 172849 0.019
2.5	0.45	50	10	2.8	2.1	2.3 +0.02			● 172845	● 173246 0.020
2.6	0.45	50	10	2.8	2.1	2.4 +0.02			● 172846	

 $\leq M1.5$ 
**4HX**

# FPS FORMING

FPS380DL-3			63 64 71 72 73 91 92 94
FPS381DL-3			63 64 71 72 73 91 92 94
FPS380VS-3			11 12 13 14
FPS381VS-3			11 12 13 14 15

FPS380DL-3	FPS381DL-3	FPS380VS-3	FPS381VS-3
------------	------------	------------	------------

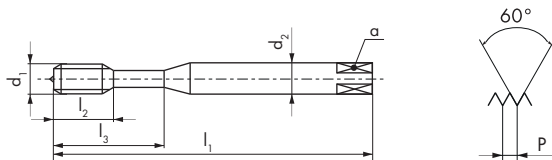
NEW
NEW

6HX
6HX
6HX
6HX

$\emptyset d_1$ M	P mm	$l_1$ mm	$l_2$ mm	$l_3$ mm	$d_2$ mm	a mm	$\frac{6HX}{\text{chip}}$ Tol.
3	0.5	56	12	18	3.5	2.7	2.8 + 0.03
3.5	0.6	56	13	20	4	3	3.25 + 0.03
4	0.7	63	14	21	4.5	3.4	3.7 + 0.03
5	0.8	70	15	25	6	4.9	4.65 + 0.03
6	1	80	17	30	6	4.9	5.55 + 0.05
8	1.25	90	20	35	8	6.2	7.4 + 0.05
10	1.5	100	22	39	10	8	9.3 + 0.05

ID
ID
ID
ID

● 170553	● 182038	● 166614	● 166616
● 175347	● 182623	● 166620	● 166622
● 170554	● 182039	● 166627	● 166629
● 182619	● 178343	● 166635	● 166637
● 182620	● 171112	● 166644	● 166646
● 182621	● 179144	● 166654	● 166656
● 182622	● 171113	● 166664	● 166666

6GX
6GX

$\emptyset d_1$ M	P mm	$l_1$ mm	$l_2$ mm	$l_3$ mm	$d_2$ mm	a mm	$\frac{6HX}{\text{chip}}$ Tol.
3	0.5	56	12	18	3.5	2.7	2.8 + 0.03
3.5	0.6	56	13	20	4	3	3.25 + 0.03
4	0.7	63	14	21	4.5	3.4	3.7 + 0.03
5	0.8	70	15	25	6	4.9	4.65 + 0.03
6	1	80	17	30	6	4.9	5.55 + 0.05
8	1.25	90	20	35	8	6.2	7.4 + 0.05
10	1.5	100	22	39	10	8	9.3 + 0.05

ID
6H
+ mm
ID
6H
+ mm

● 166697 0.020	● 166617 0.020
● 166687 0.021	● 166623 0.021
● 166688 0.022	● 166630 0.022
● 166689 0.024	● 166638 0.024
● 166686 0.026	● 166647 0.026
● 166740 0.028	● 166657 0.028
● 166739 0.032	● 166667 0.032



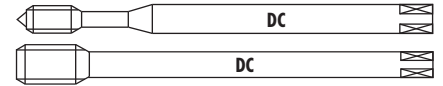

# FPS FORMING

**FPS481VS-3**

VS
11 12 13 14  
15
**FPS581VS-3**

EL VS
11 12 13 14  
15
**FPS681VS-3**

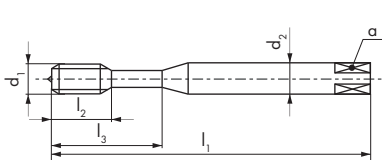
EL VS
11 12 13 14  
15
**FPS481VS-3**
**FPS581VS-3**
**FPS681VS-3**

6HX
6HX
6HX

$\phi_1$ M	P mm	$l_1$ mm	$l_2$ mm	$d_2$ mm	a mm	6HX Tol.	ID
12	1.75	110	24	9	7	11.2 + 0.05	● 166673
14	2	110	28	11	9	13.1 + 0.05	● 166678
16	2	110	30	12	9	15.1 + 0.05	● 166683
20	2.5	140	36	16	12	18.85 + 0.05	● 168713

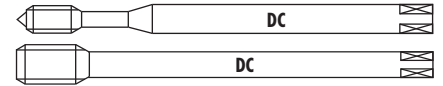
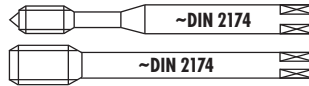
$\phi_1$ M	P mm	$l_1$ mm	$l_2$ mm	$l_3$ mm	$d_2$ mm	a mm	6HX Tol.	ID	ID
3	0.5	100	12	18	3.5	2.7	2.8 + 0.03	● 172824	
4	0.7	125	14	21	4.5	3.4	3.7 + 0.03	● 172826	
5	0.8	140	15	25	6	4.9	4.65 + 0.03	● 172828	
6	1	160	17	30	6	4.9	5.55 + 0.05	● 172830	
8	1.25	180	20	35	8	6.2	7.4 + 0.05	● 172832	
10	1.5	200	22	39	10	8	9.3 + 0.05	● 172834	
12	1.75	224	24		9	7	11.2 + 0.05		● 172836



# FPS FORMING

FPS384VS-3



11 12 13 14  
15

FPS484VS-3



11 12 13 14  
15

FPS584VS-3



11 12 13 14  
15

FPS684VS-3



11 12 13 14  
15

FPS384VS-3

FPS484VS-3

FPS584VS-3

FPS684VS-3



6HX

6HX

6HX

6HX

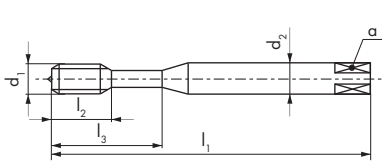

$\phi d_1$ M	P mm	$l_1$ mm	$l_2$ mm	$l_3$ mm	$d_2$ mm	a mm	6HX Tol.
3	0.5	56	12	18	3.5	2.7	2.8 +0.03
4	0.7	63	14	21	4.5	3.4	3.7 +0.03
5	0.8	70	15	25	6	4.9	4.65 +0.03
6	1	80	17	30	6	4.9	5.55 +0.05
8	1.25	90	20	35	8	6.2	7.4 +0.05
10	1.5	100	22	39	10	8	9.3 +0.05
12	1.75	110	24		9	7	11.2 +0.05
14	2	110	28		11	9	13.1 +0.05
16	2	110	30		12	9	15.1 +0.05

ID

ID

- 166737
- 166738
- 166640
- 166650
- 166660
- 166670

- 166675
- 166680
- 166685

$\phi d_1$ M	P mm	$l_1$ mm	$l_2$ mm	$l_3$ mm	$d_2$ mm	a mm	6HX Tol.
3	0.5	100	12	18	3.5	2.7	2.8 +0.03
4	0.7	125	14	21	4.5	3.4	3.7 +0.03
5	0.8	140	15	25	6	4.9	4.65 +0.03
6	1	160	17	30	6	4.9	5.55 +0.05
8	1.25	180	20	35	8	6.2	7.4 +0.05
10	1.5	200	22	39	10	8	9.3 +0.05
12	1.75	224	24		9	7	11.2 +0.05

ID

ID

- 172763
- 172766
- 172769
- 172772
- 172775
- 172778

- 172781

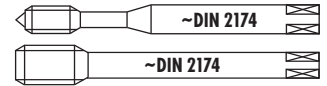

## FAS FORMING

**FAS380VS-3** VS

**FAS381VS-3** VS

**FAS481VS-3** VS

FAS380VS-3

FAS381VS-3

FAS481VS-3

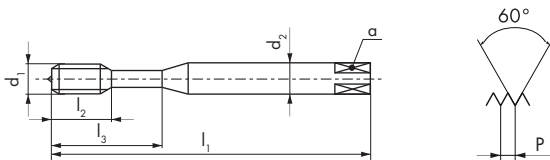

6HX

6HX

6HX

$\emptyset d_1$ M	P mm	$l_1$ mm	$l_2$ mm	$l_3$ mm	$d_2$ mm	$a$ mm	6HX Tol.
3	0.5	56	12	18	3.5	2.7	2.8 +0.03
3.5	0.6	56	13	20	4	3	3.25 +0.03
4	0.7	63	14	21	4.5	3.4	3.7 +0.03
5	0.8	70	15	25	6	4.9	4.65 +0.03
6	1	80	17	30	6	4.9	5.55 +0.05
8	1.25	90	20	35	8	6.2	7.4 +0.05
10	1.5	100	22	39	10	8	9.3 +0.05
12	1.75	110	24		9	7	11.2 +0.05
14	2	110	28		11	9	13.1 +0.05
16	2	110	30		12	9	15.1 +0.05
20	2.5	140	36		16	12	18.85 +0.05

ID

ID

ID

● 170603	● 166612
● 170605	● 166618
● 170607	● 166624
● 170609	● 166632
● 170611	● 166641
● 170616	● 166651
● 170618	● 166661
	● 166671
	● 166676
	● 166681
	● 168711

6GX

6GX

$\emptyset d_1$ M	P mm	$l_1$ mm	$l_2$ mm	$l_3$ mm	$d_2$ mm	$a$ mm	6HX Tol.
3	0.5	56	12	18	3.5	2.7	2.8 +0.03
3.5	0.6	56	13	20	4	3	3.25 +0.03
4	0.7	63	14	21	4.5	3.4	3.7 +0.03
5	0.8	70	15	25	6	4.9	4.65 +0.03
6	1	80	17	30	6	4.9	5.55 +0.05
8	1.25	90	20	35	8	6.2	7.4 +0.05
10	1.5	100	22	39	10	8	9.3 +0.05
12	1.75	110	24		9	7	11.2 +0.05
14	2	110	28		11	9	13.1 +0.05
16	2	110	30		12	9	15.1 +0.05

ID

6H  
+ mm

ID

6H  
+ mm

● 166703 0.020
● 166704 0.021
● 166705 0.022
● 166706 0.024
● 166707 0.026
● 166708 0.028
● 166709 0.032
● 166710 0.034
★ 166711 0.038
● 166712 0.038

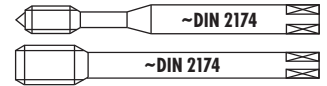

# FAS FORMING

FAS384VS-3



FAS484VS-3



FAS384VS-3

FAS484VS-3

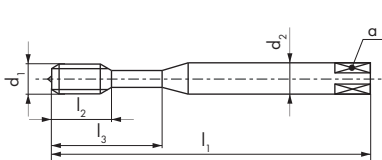

$\varnothing d_1$ M	P mm	$l_1$ mm	$l_2$ mm	$l_3$ mm	$d_2$ mm	a mm	6HX Tol.	
3	0.5	56	12	18	3.5	2.7	2.8	+ 0.03
4	0.7	63	14	21	4.5	3.4	3.7	+ 0.03
5	0.8	70	15	25	6	4.9	4.65	+ 0.03
6	1	80	17	30	6	4.9	5.55	+ 0.05
8	1.25	90	20	35	8	6.2	7.4	+ 0.05
10	1.5	100	22	39	10	8	9.3	+ 0.05
12	1.75	110	24		9	7	11.2	+ 0.05
14	2	110	28		11	9	13.1	+ 0.05
16	2	110	30		12	9	15.1	+ 0.05

ID

ID

● 166741

● 166742

● 166690

● 166691

● 166692

● 166693

● 166694

● 166695

● 166696

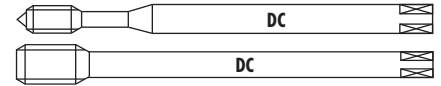

# FAS FORMING

FAS581VS-3



FAS681VS-3



FAS584VS-3



FAS684VS-3



FAS581VS-3

FAS681VS-3

FAS584VS-3

FAS684VS-3



6HX

6HX

6HX

6HX

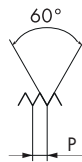
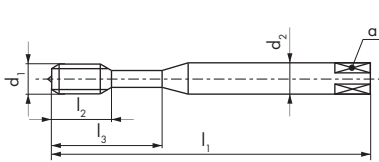

$\emptyset d_1$ M	P mm	$l_1$ mm	$l_2$ mm	$l_3$ mm	$d_2$ mm	a mm	6HX Tol.
3	0.5	100	12	18	3.5	2.7	2.8 +0.03
4	0.7	125	14	21	4.5	3.4	3.7 +0.03
5	0.8	140	15	25	6	4.9	4.65 +0.03
6	1	160	17	30	6	4.9	5.55 +0.05
8	1.25	180	20	35	8	6.2	7.4 +0.05
10	1.5	200	22	39	10	8	9.3 +0.05
12	1.75	224	24		9	7	11.2 +0.05

ID

ID

ID

ID

● 172784

● 172805

● 172787

● 172808

● 172790

● 172811

● 172793

● 172814

● 172796

● 172817

● 172799

● 172820

● 172802

● 172822

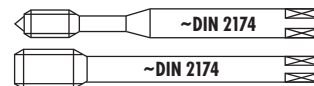

## FPS FAS FORMING

FPS381VS-3  VS 

FPS481VS-3  VS 

FAS381VS-3  VS 

FAS481VS-3  VS 

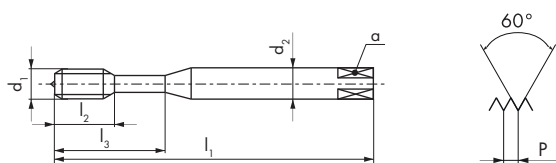

FPS381VS-3	FPS481VS-3	FAS381VS-3	FAS481VS-3
------------	------------	------------	------------



Ø d <sub>1</sub> MF	P mm	l <sub>1</sub> mm	l <sub>2</sub> mm	l <sub>3</sub> mm	d <sub>2</sub> mm	a mm	6HX Tol.
4	0.5	63	14	21	4.5	3.4	3.8 +0.03
5	0.5	70	15	25	6	4.9	4.8 +0.03
6	0.5	80	17	30	6	4.9	5.8 +0.03
6	0.75	80	17	30	6	4.9	5.65 +0.03
8	0.75	90	20	35	8	6.2	7.65 +0.03
8	1	90	20	35	8	6.2	7.55 +0.05
10	1	100	22	39	10	8	9.55 +0.05
12	1	100	19		9	7	11.55 +0.05
14	1.5	100	24		11	9	13.3 +0.05
16	1.5	100	26		12	9	15.3 +0.05

ID	ID	ID	ID
● 166631		● 166625	
● 166639		● 166633	
● 166699		● 166698	
● 166649		● 166642	
● 166702		● 166700	
● 166659		● 166652	
● 166669		● 166662	
	● 166674		● 166672
	● 166679		● 166677
	● 166684		● 166682

## FS FPS FORMING FAS

FS380VS-3 VS 11 12 13 14  
21

FPS381VS-3 VS 11 12 13 14  
15

FAS381VS-3 VS 21 22 23 24  
41 51 61

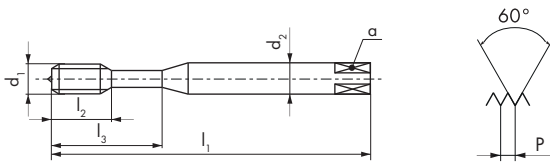

FS380VS-3

FPS381VS-3

FAS381VS-3



2BX

2BX

2BX

$\emptyset$ " d <sub>1</sub> UNC	P TPI	d <sub>1</sub> mm	l <sub>1</sub> mm	l <sub>2</sub> mm	l <sub>3</sub> mm	d <sub>2</sub> mm	a mm	$\emptyset$ 2BX Tol.
2	56	2.18	45	9		2.8	2.1	1.95 + 0.02
4	40	2.84	56	12	18	3.5	2.7	2.55 + 0.03
6	32	3.5	56	13	20	4	3	3.15 + 0.03
8	32	4.16	63	14	21	4.5	3.4	3.8 + 0.03
10	24	4.82	70	15	25	6	4.9	4.35 + 0.05
1/4	20	6.35	80	17	30	7	5.5	5.75 + 0.05

ID	ID	ID
● 157285		
	● 170063	● 170065
	● 166713	● 166725
	● 166714	● 166726
	● 166715	● 166727
	● 166716	● 166728

## FS FPS FORMING FAS

FS380VS-5



VS

11 12 13 14  
21

FPS381VS-3



VS

11 12 13 14  
15

FAS381VS-3



VS

21 22 23 24  
41 51 61

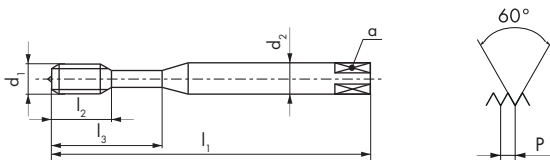

FS380VS-5

FPS381VS-3

FAS381VS-3



2BX

2BX

2BX

Ø" d <sub>1</sub> UNF	P TPI	d <sub>1</sub> mm	l <sub>1</sub> mm	l <sub>2</sub> mm	l <sub>3</sub> mm	d <sub>2</sub> mm	a mm	φ <sub>fl</sub> mm	Tol.
0	80	1.52	40	4.6		2.5		1.37	+ 0.02
10	32	4.82	70	15	25	6	4.9	4.45	+ 0.03
1/4	28	6.35	80	17	30	7	5.5	5.95	+ 0.05
5/16	24	7.93	90	20	35	8	6.2	7.45	+ 0.05

ID	ID	ID
● 161498		
	● 166718	● 166730
	● 166719	● 166731
	● 166720	● 166732





## FPS FAS FORMING

FPS481VS-3  VS 

FAS481VS-3  VS 

FPS481VS-3

FAS481VS-3

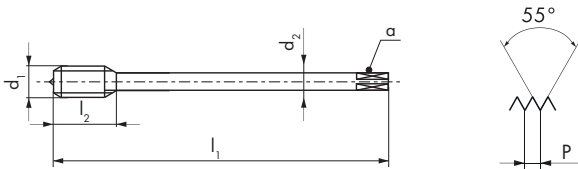

$\frac{\text{Ø}'' d_1}{G}$	P TPI	$d_1$ mm	$l_1$ mm	$l_2$ mm	$d_2$ mm	a mm		Tol.
1/8	28	9.72	90	22	7	5.5	9.25	+ 0.05
1/4	19	13.15	100	20	11	9	12.5	+ 0.05
3/8	19	16.66	100	20	12	9	16	+ 0.05
1/2	14	20.95	125	22	16	12	20	+ 0.05

ID

ID

- 166721
- 166722
- 166723
- 166724

- 166733
- 166734
- 166735
- 166736

# SCHNEIDEISEN MIT SCHÄLANSCHNITT

Der Schälanschnitt bewirkt ein freies Abfließen der Späne nach vorne und eine Verringerung des Schnittmomentes. Spänestauungen in den Spanlöchern werden dadurch vermieden. Das Ergebnis ist eine verbesserte Oberflächengüte bei den geschnittenen Gewinden und eine höhere Standzeit des Werkzeuges.

**Schneideisen, die auf Maschinen eingesetzt werden, müssen deshalb mit Schälanschnitt bestellt werden.**



## DIES WITH SPIRAL ENTRY

A spiral entry results in a free flow of chips ahead of the die and a reduction in the cutting torque. Blocking of the clearance holes by chips is avoided. This results in an improved surface finish on the cut threads and a longer die life.

**Hence dies for machine use must be ordered with spiral entry.**

# HOCHLEISTUNGS-SCHNEIDEISEN

## HIGH PERFORMANCE THREAD CUTTING DIES

### N5110/N5120



mit Schälanschnitt ab  $\varnothing$  3 mm  
with spiral entry from  $\varnothing$  3 mm

#### Runde Schneideisen aus HSS, nach DIN EN Norm

für Hand- oder Maschinengebrauch

- Für die Bearbeitung von Stahl bis 800 N/mm<sup>2</sup>
- Verschiedene Versionen zum Schneiden unterschiedlichster Werkstoffe

#### Round dies in HSS, as per DIN EN standards

for machine and manual use

- For machining steels up to 800 N/mm<sup>2</sup>
- Different versions for cutting a wide range of materials

### Z5120



mit Schälanschnitt ab  $\varnothing$  2 mm  
with spiral entry from  $\varnothing$  2 mm

#### Runde Schneideisen aus HSSE, nach DIN EN Norm

- Feine Spanaufteilung durch höhere Schneidstollenzahl und längeren Anschnitt 2 x P
- Für die Bearbeitung von rost- und säurebeständigen Stählen, Vergütungsstählen, Einsatzstählen usw. bis 1'200 N/mm<sup>2</sup> und kurzspanende ALU-Legierungen

#### Round dies in HSSE, as per DIN EN standards

for machine and manual use

- Fine chips due to more clearance holes and thus more cutting edges, and the extension of the chamfer to 2 x P
- For machining stainless steels, heat-treatable steels, case-hardening steels etc. up to 1'200 N/mm<sup>2</sup> and short-chipping ALU alloys

### Z5120 LL Long Life



mit Schälanschnitt ab  $\varnothing$  2 mm  
with spiral entry from  $\varnothing$  2 mm

#### Runde Schneideisen aus HSSE (ASP), nach DIN EN Norm

- Feinste Spanaufteilung durch höchste Schneidstollenzahl und längeren Anschnitt 2.25 x P
- Für Grossserien
- Long Life steht für enorme Standzeit
- Für die Bearbeitung von rost- und säurebeständigen Stählen, Vergütungsstählen, Einsatzstählen usw. bis 1'200 N/mm<sup>2</sup> und kurzspanende ALU-Legierungen

#### Round dies in HSSE (ASP), as per DIN EN standards

- Very fine chips due to maximum number of clearance holes and thus still more cutting edges, and the extension of the chamfer to 2.25 x P
- For the processing of large series
- Exceptionally long die life
- For machining stainless steels, heat-treatable steels, case-hardening steels etc. up to 1'200 N/mm<sup>2</sup> and short-chipping ALU alloys

### MS5120



mit Schälanschnitt  
with spiral entry

#### Runde Schneideisen aus HSS, nach DIN EN Norm

- Mit erweiterten Spanlöchern für bessere Spanabfuhr
- Für die Bearbeitung von kurzspanendem Messing

#### Round dies in HSS, as per DIN EN standards

- With enlarged clearance holes to prevent chips crowding
- For the machining of short-chipping brass

### N5220 Z5220

#### MS5220



mit Schälanschnitt  
with spiral entry

#### Automaten-Schneideisen aus HSS (Z = HSSE), mit 2 Aufschraublöchern

- Anwendungsgebiet entsprechend Typ N5120, MS5120 und Z5120
- Vorteil: durch die geringere Massenträgheit des Schneideisenhalters sind höhere Drehzahlen / Standzeiten möglich

#### Button dies for Swiss automatics, in HSS (Z = HSSE), with 2 securing holes

- Application area according to type N5120, MS5120 and Z5120
- Advantage: the low inertia of the die holder permits higher spindle speeds and extends die life

### N5310



#### Sechskant-Schneideisen aus HSS, Baumassee nach DIN 382

- Zum Nachschneiden und Reparieren von beschädigten Gewinden oder zum Schneiden an schwer zugänglichen Stellen

#### Hexagon die nuts in HSS, general dimensions as per DIN 382

- For recutting and reclaiming damaged threads or for cutting threads in difficult locations

### N5420



mit Schälanschnitt ab  $\varnothing$  3 mm  
with spiral entry from  $\varnothing$  3 mm

#### Glockenform-Schneideisen aus HSS

- Vorteil: freies Abfließen der Späne und verbesserte Kühl-Schmiermittelzufuhr durch offene Spanräume, auch wenn nahe am Bund geschnitten wird

#### Bell form type thread cutting dies in HSS

- Advantage: free chip flow and improved coolant supply thanks to the open clearance holes, even when cutting threads close to shoulders

# ANWENDUNGSTABELLE FÜR SCHNEIDEISEN

## APPLICATION CHART FOR CUTTING DIES

Werkstoffbezeichnung	Werkstoffnummer	Schnittgeschwindigkeit m/min (Richtwerte)	Kühl-Schmiermittel	Spanwinkel	Schneideisentyp
Allgemeine Baustähle	St37-2, St50-2	8 - 12	Schneidöl	17 - 22°	N5...
Automatenstähle	9SMn28, 9SMnPb28	10 - 14	Schneidöl	17 - 22°	N5...
Einsatzstähle	C15, Ck15, 16MnCr5	6 - 10	Schneidöl / Spezial-Schneidöl	17 - 22°	Z5... / Z5... LL
Vergütungsstähle	C35Pb, C45	5 - 8	Schneidöl / Spezial-Schneidöl	13 - 18°	Z5... / Z5... LL
Rost- u. säurebeständige Stähle	X12CrMoS17, X12CrNiS188	4 - 6	Spezial-Schneidöl	13 - 18°	Z5... / Z5... LL
Messing kurzspanend, Ms 58	CuZn39Pb2, CuZn40Pb2	20 - 30	Schneidöl	6 - 11°	MS5...
Messing langspanend, Ms 60	CuZn20, CuZn37	12 - 18	Schneidöl	10 - 15°	N5...
Alu-Legierungen, kurzspanend	GD-ALSi8Cu3, GD-ALSi12	8 - 12	Spezial-Schneidöl, Petroleum	18 - 23°	Z5...
Reintitan	Ti2	5 - 8	Spezial-Schneidöl	19 - 24°	Z5... / Z5... LL

Schneideisen mit jeweils speziell angepasstem Spanwinkel für Grauguss, Messing bleifrei, Bronze, Rotguss, Kupfer, Alu-Legierungen langspanend sind als Spezialanfertigung lieferbar.

Auf Wunsch können wir auch Schneideisen in beschichteter Ausführung liefern. Preis und Lieferfrist auf Anfrage.

Material designation	Material Number	Cutting speed m/min (guide line)	Cutting fluid	Rake angle	Type of die
General engineering steels	St37-2, St50-2	8 - 12	Cutting oil	17 - 22°	N5...
Free-cutting steels	9SMn28, 9SMnPb28	10 - 14	Cutting oil	17 - 22°	N5...
Case hardening steels	C15, Ck15, 16MnCr5	6 - 10	Cutting oil / Special cutting oil	17 - 22°	Z5... / Z5... LL
Heat-treatable steels	C35Pb, C45	5 - 8	Cutting oil / Special cutting oil	13 - 18°	Z5... / Z5... LL
Stainless steels	X12CrMoS17, X12CrNiS188	4 - 6	Special cutting oil	13 - 18°	Z5... / Z5... LL
Short chip brass Ms 58	CuZn39Pb2, CuZn40Pb2	20 - 30	Cutting oil	6 - 11°	MS5...
Long chip brass Ms 60	CuZn20, CuZn37	12 - 18	Cutting oil	10 - 15°	N5...
Al-alloyed, short-chipping	GD-ALSi8Cu3, GD-ALSi12	8 - 12	Spezial cutting oil, Paraffin	18 - 23°	Z5...
Pure titanium	Ti2	5 - 8	Special cutting oil	19 - 24°	Z5... / Z5... LL

Cutting dies with specially adapted rake angle for grey cast iron, lead-free brass, bronze, gunmetal, copper and long-chipping aluminium alloys are available as special execution.

On request, we can also supply dies in a coated version. Price and delivery time on request.

## TOLERANZEN FÜR M- UND MF-GEWINDE

## TOLERANCES FOR M AND MF THREADS

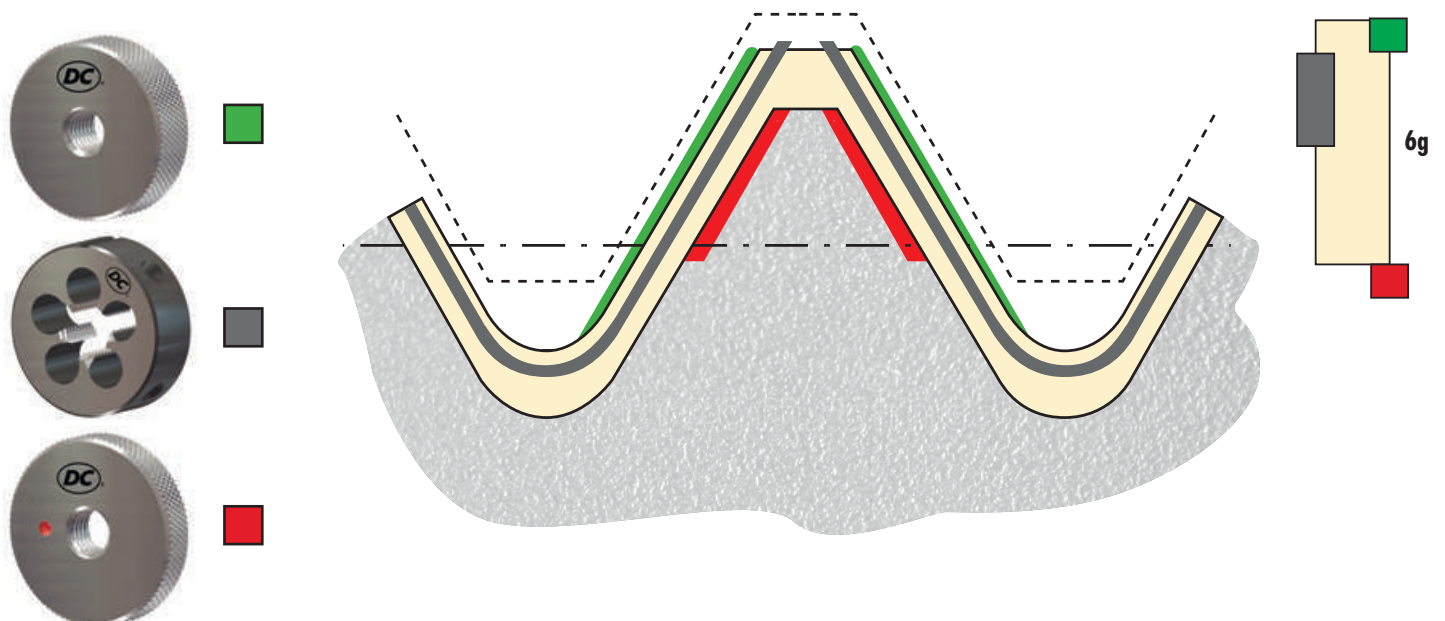

# KODIERUNG – CODIFICATION

## DC®-Schneideisen



Beispiel

Z	51	20	LL	SP
---	----	----	----	----

Normale Werkstoffe	N				
Messing kurzspanend	MS				
Zähe Werkstoffe	Z				
Runde Schneideisen*		51			
Automaten-Schneideisen, mit 2 Aufschraublöchern		52			
Sechskant-Schneideisen		53			
Glocken-Schneideisen		54			
Geschlossen, Form B			10		
Geschlossen, Form B, mit Schälanschnitt,			20		
Long Life - Hochleistungsschneideisen				LL	
Spezialausführung					SP

\*Für Maschinengebrauch Schneideisen mit Schälanschnitt verwenden.

## DC® Dies



Example

Z	51	20	LL	SP
---	----	----	----	----

Normal materials	N				
Short chip brass	MS				
Tough materials	Z				
Round dies*		51			
Button dies for automatic lathes, with 2 securing holes		52			
Hexagon die nuts		53			
Bell form dies		54			
Solid, form B			10		
Solid, form B, with spiral entry			20		
Long Life - High performance dies				LL	
Special execution					SP

\*For production, use dies with spiral entry.

### Runde Schneideisen aus HSS, nach DIN EN Norm

DIN EN 22568: für M-, MF-, UNC-, UNF-, UNEF, UN-, UNS- und W-Gewinde

≈ DIN EN 22568: für kegeliges Amerikanisches Rohrgewinde NPT gemäss ASME B1.20.1 und NPTF gemäss ANSI B1.20.3

≈ DIN EN 22568: für TR-Gewinde gemäss DIN 103

DIN EN 24231: für G-Gewinde (BSP) gemäss DIN EN ISO 228

≈ DIN EN 24230: für kegeliges Whitworth-Rohrgewinde R gemäss DIN EN 10226, ISO 7-1

≈ DIN 40434 und DIN EN 22568: für PG-Gewinde (Stahlpanzerrohr-Gewinde) nach DIN 40430

### Round dies in HSS, as per DIN EN standards

DIN EN 22568: for M-, MF-, UNC-, UNF-, UNEF, UN-, UNS- and W (BSW) threads

≈ DIN EN 22568: for American standard taper pipe thread NPT as per ASME B1.20.1 and NPTF as per ANSI B1.20.3

≈ DIN EN 22568: for TR threads as per DIN 103

DIN EN 24231: for G threads (BSP) as per DIN EN ISO 228

≈ DIN EN 24230: for Tapered Whitworth pipe thread R as per DIN EN 10226, ISO 7-1

≈ DIN 40434 and DIN EN 22568: for PG threads (steel conduit thread) as per DIN 40430

**N:** HSS, Anschnittlänge 1.75 x P

**MS:** HSS, geläppt, Anschnittlänge 1.25 x P

**Z:** HSSE, nitriert ab Ø 3 mm (P = 0.5 mm),  
Anschnittlänge 2 x P, mit Schälanschnitt ab Ø 2 mm

**Z-LL:** ASP, nitriert ab Ø 3 mm (P = 0.5 mm),  
Anschnittlänge 2.25 x P, mit Schälanschnitt ab Ø 2 mm

**N:** HSS, chamfer length 1.75 x P











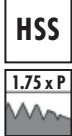

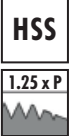
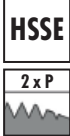

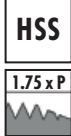
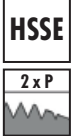











**MS:** HSS, lapped, chamfer length 1.25 x P

**Z:** HSSE, nitrided from Ø 3 mm (P = 0.5 mm),  
chamfer length 2 x P, with spiral entry from Ø 2 mm

**Z-LL:** ASP, nitrided from Ø 3 mm (P = 0.5 mm), chamfer  
length 2.25 x P, with spiral entry from Ø 2 mm

# Inhaltsverzeichnis — Runde-, Automaten-, Sechskant- und Glocken-Schneideisen



## Directory — Round dies, button dies for Swiss automatics, hexagon die nuts and bell form dies







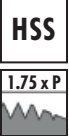
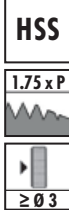









		N		MS	Z		N	Z
<b>Merkmale</b> <b>Characteristics</b>		 1.75 x P	 1.75 x P	 1.25 x P	 2 x P	 2.25 x P	 1.75 x P	 2 x P
		 ≥ Ø 3	 ≥ Ø 3	 ≥ Ø 3	 ≥ Ø 2	 ≥ Ø 2	 ≥ Ø 3	 ≥ Ø 2
		 NI	 NI	 NI	 NI	 NI	 NI	 NI
								
<b>Typ</b> <b>Type</b>		<b>N5110</b>	<b>N5120</b>	<b>MS5120</b>	<b>Z5120</b>	<b>Z5120LL</b>	<b>N5220</b>	<b>Z5220</b>
<b>M 6g</b>	ISO DIN 13	272	272		273	273	286	286
<b>M 6e</b>	ISO DIN 13		272				286	
<b>M 6g LH</b>	ISO DIN 13		272					
<b>MF 6g</b>	ISO DIN 13	274	274 - 276		274 - 275		287	
<b>MF 6e</b>	ISO DIN 13		274					
<b>MF 6g LH</b>	ISO DIN 13		274 - 276					
<b>UNC</b>	ASME B1.1	277	277					
<b>UNF</b>	ASME B1.1	278	278					
<b>UNEF</b>	ASME B1.1		279					
<b>UN</b>	ASME B1.1		279					
<b>UNS</b>	ASME B1.1		279					
<b>G (BSP)</b>	DIN EN ISO 228		280	281	281			
<b>G (BSP) LH</b>	DIN EN ISO 228		280					
<b>G (BSP) -0.1mm</b>	DIN EN ISO 228			281				
<b>R (BSPT)</b>	DIN EN 10226		282					
<b>NPT</b>	ASME B1.20.1		283					
<b>NPTF</b>	ANSI B1.20.3		283					
<b>PG</b>	DIN 40430		284					
<b>TR</b>	DIN 103		284					
<b>W (BSW)</b>	BS 84		285					
<b>W (BSW) LH</b>	BS 84		285					





## Piktogramme - Pictographs

N	
	
	
<b>N5310</b>	<b>N5420</b>
288	289
288	
289	
289	

	HSS HSS
	HSSE HSSE
	1.25 Gewindegänge 1.25 chamfered threads
	1.75 Gewindegänge 1.75 chamfered threads
	2 Gewindegänge 2 chamfered threads
	Schälanschnitt ab $\varnothing 3$ mm Spiral entry from $\varnothing 3$ mm
	Schälanschnitt, beidseitig, ab $\varnothing 3$ mm Spiral entry on both sides from $\varnothing 3$ mm
	Anzahl Spannuten Number of flutes
	Vordrehdurchmesser Turned diameters
	Nitriert ( $d1 \geq 3$ mm, $P \geq 0.5$ mm) Nitrided ( $d1 \geq 3$ mm, $P \geq 0.5$ mm)
	Schneideisen mit 2 Aufschraublöchern Die with 2 securing holes
	Toleranz 6g Tolerance 6g
	Toleranz 6e Tolerance 6e
	Toleranz "Medium Class" Tolerance "Medium Class"
	Toleranz A Tolerance A
	Konisches Gewinde 1:16 (NPT - NPTF - R) Tapered thread 1:16 (NPT - NPTF - R)
	Linksgewinde Left-hand thread

N5110								N5110		N5120		N5120 LH		N5120	
$\emptyset d_1$ M	P mm	$d_2$ mm	$l_1$ mm					ID	ID	ID	ID	6g - mm			
1	0.25	16	5	3		0.97		● 103851							
1.1	0.25	16	5	3		1.07		● 124659							
1.2	0.25	16	5	3		1.17		● 103852							
1.4	0.3	16	5	3		1.36		● 103853							
1.6	0.35	16	5	3		1.54		● 103855							
1.7	0.35	16	5	3		1.64		● 103856							
1.8	0.35	16	5	3		1.74		● 103857							
2	0.4	16	5	3		1.93		● 103864							
2.2	0.45	16	5	3		2.13		● 103867							
2.3	0.4	16	5	3		2.23		● 103869							
2.5	0.45	16	5	3		2.43		● 103872							
2.6	0.45	16	5	3		2.53		● 103876							
3	0.5	20	5	3	4	2.92	2.9	● 103879	● 104067	● 104068	● 104066	0.030			
3.5	0.6	20	5	3	4	3.41		● 103880	● 104071	● 104072					
4	0.7	20	5	3	4	3.91	3.87	● 103881	● 104114	● 104115	● 104113	0.035			
4.5	0.75	20	7	4		4.4		* 103882	● 104117						
5	0.8	20	7	4	4	4.9	4.87	● 103883	● 104146	● 104147	● 104145	0.035			
5.5	0.9	20	7	4		5.4		* 103884							
6	1	20	7	4	4	5.88	5.85	● 103885	● 104165	● 104166	● 104164	0.035			
7	1	25	9	4	4	6.88		● 103886	● 104174	● 104175					
8	1.25	25	9	4	4	7.87	7.83	● 103887	● 104186	● 104187	● 104185	0.035			
9	1.25	25	9	4		8.87		* 103888	● 104191						
10	1.5	30	11	4	4	9.85	9.82	● 103858	● 103953	● 103954	● 103952	0.035			
12	1.75	38	14	4	4	11.83	11.8	● 103859	● 103973	● 103974	● 103972	0.035			
14	2	38	14	4	4	13.82		● 103860	● 103989	● 103990					
16	2	45	18	4	4	15.82		● 103861	● 104003	● 104004					
18	2.5	45	18	5		17.79			● 104015						
20	2.5	45	18	5	5	19.79		● 103878	● 104028	● 104029					
22	2.5	55	22	5		21.79			● 104035						
24	3	55	22	5	5	23.76			● 104043	● 104044					
27	3	65	25	5		26.76			● 104058						
30	3.5	65	25	6	6	29.73			● 104079	● 104080					
33	3.5	65	25	6		32.73			● 104089						
36	4	65	25	7		35.7			● 104100						
								≤ M1.4		6h					

















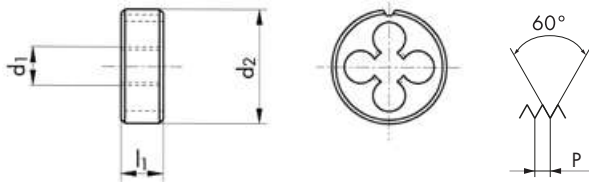

Z5120		NI		13	14	21	Z5120	Z5120 LL			
Z5120 LL		NI		13	14	15	21				
$\emptyset d_1$ M	P mm	$d_2$ mm	$l_1$ mm	Z5120	Z5120LL	$\rightarrow 6g \leftarrow$	ID	ID			
2	0.4	16	3.5	4	4	1.93	● 125269	● 105115			
2.5	0.45	16	5	4	4	2.43	● 104779	● 105116			
2.6	0.45	16	5	4		2.53	★ 104780				
3	0.5	20	5	4	5	2.92	● 104788	● 105117			
3.5	0.6	20	5	4		3.41	● 104789				
4	0.7	20	5	4	5	3.91	● 104790	● 105118			
5	0.8	20	7	4	5	4.9	● 104792	● 105119			
6	1	20	7	4	5	5.88	● 104795	● 105120			
7	1	25	9	4		6.88	★ 111424				
8	1.25	25	9	5	6	7.87	● 104798	● 105121			
10	1.5	30	11	5	6	9.85	● 104767	● 105122			
12	1.75	38	14	5	6	11.83	● 104770	● 105123			
14	2	38	14	5		13.82	● 104773				
16	2	45	18	5		15.82	● 104776				
18	2.5	45	18	5		17.79	● 104778				
20	2.5	45	18	5		19.79	● 104783				
24	3	55	22	6		23.76	● 104787				

N5120								N5120	N5120 LH	N5120	Z5120	
Z5120												
								6g	6g	6e	6g	
Ø d <sub>1</sub> MF	P mm	d <sub>2</sub> mm	l <sub>1</sub> mm	N	Z	≥6g <sub>←</sub>	≥6e <sub>←</sub>	ID	ID	ID	6g - mm	ID
*2	0.25	16	5	4		1.93		● 103863				
*2.5	0.35	16	5	4		2.44		● 103871				
3	0.35	20	5	4		2.94		● 104064				
3.5	0.35	20	5	4		3.44		● 104069				
4	0.35	20	5	4		3.94		● 104108				
4	0.5	20	5	4		3.93		● 104110				
4.5	0.5	20	5	4		4.43		● 104116				
5	0.5	20	5	4	4	4.93	4.9	● 104141	● 104142	● 104140	0.030	● 104791
5	0.75	20	7	4		4.9		● 104143				
5.5	0.5	20	5	4		5.43		● 104148				
6	0.5	20	5	4	4	5.93		● 104159	● 104160			● 104793
6	0.75	20	7	4	4	5.9		● 104162	● 104163			● 104794
7	0.5	25	9	4		6.93		● 104169				
7	0.75	25	9	4		6.9		● 104171				
8	0.5	25	9	5		7.93		● 104177				
8	0.75	25	9	4	4	7.9		● 104180				● 104796
8	1	25	9	4	4	7.88	7.85	● 104183	● 104184	● 104182	0.035	● 104797
9	0.5	25	9	5		8.93		● 104188				
9	0.75	25	9	5		8.9		● 104189				
9	1	25	9	5		8.88		● 104190				
10	0.5	30	11	5		9.93		● 103942				
10	0.75	30	11	5	5	9.9		● 103945				● 104765
10	1	30	11	5	5	9.88	9.85	● 103948	● 103949	● 103947	0.035	● 104766
10	1.25	30	11	4		9.86		● 103950	● 103951			
11	0.75	30	11	5		10.9		● 103956				
11	1	30	11	5		10.88		● 103957				
11	1.25	30	11	5		10.86		● 103958				
12	0.5	38	10	5		11.93		● 103960				
12	0.75	38	10	5		11.9		● 103962				
12	1	38	10	5	5	11.88	11.85	● 103965	● 103966	● 103964	0.035	● 104768
12	1.25	38	10	4		11.86		● 103967	● 103968			
12	1.5	38	10	4	5	11.85		● 103970	● 103971			● 104769
13	1	38	10	5		12.88		● 103976				
* N5110								P 0.25 <b>6h</b>				

N5120							N5120	N5120 LH	Z5120
Z5120									
							1.75 x P	1.75 x P	2 x P
							6g	6g	6g
Ø d <sub>1</sub> MF	P mm	d <sub>2</sub> mm	l <sub>1</sub> mm	N	Z	6g	ID	ID	ID
14	0.5	38	10	5		13.93	● 103977		
14	0.75	38	10	5		13.9	● 103979		
14	1	38	10	5	5	13.88	● 103981	● 103982	● 104771
14	1.25	38	10	5		13.86	● 103983		
14	1.5	38	10	5	5	13.85	● 103986	● 103987	● 104772
15	1	38	10	5		14.88	● 103991		
15	1.5	38	10	5		14.85	● 103992		
16	1	45	14	5	5	15.88	● 103996	● 103997	● 104774
16	1.25	45	14	5		15.86	● 103998		
16	1.5	45	14	5	5	15.85	● 104000	● 104001	● 104775
17	1	45	14	5		16.88	● 104005		
18	1	45	14	5		17.88	● 104008		
18	1.5	45	14	5		17.85	● 104011	● 104012	
18	2	45	14	5		17.82	● 104013		
19	1	45	14	6		18.88	● 104017		
20	1	45	14	6	6	19.88	● 104021	● 104022	● 104781
20	1.5	45	14	6	6	19.85	● 104024	● 104025	● 104782
20	2	45	14	6		19.82	● 104026		
21	1	45	14	7		20.88	● 111386		
22	1	55	16	6		21.88	● 104030		
22	1.5	55	16	5		21.85	● 104032		
22	2	55	16	5		21.82	● 104034		
23	1	55	16	6		22.88	● 121704		
24	1	55	16	6		23.88	● 104037		
24	1.5	55	16	6		23.85	● 104039		
24	2	55	16	6		23.82	● 104041	● 104042	
25	1	55	16	6		24.88	● 104045		
25	1.5	55	16	6		24.85	● 104046		
26	1	55	16	7		25.88	● 104049		
26	1.5	55	16	6		25.85	● 104050		
26	2	55	16	6		25.82	● 104052		
27	1	65	18	6		26.88	● 104053		
27	1.5	65	18	6		26.85	● 104054		
27	2	65	18	6		26.82	● 104056		

						N5120	N5120 LH		
<p>N5120   </p> <p>N5120 LH    </p>									
									
$\emptyset d_1$ MF	P mm	$d_2$ mm	$l_1$ mm		 6g	ID	ID		
28	1	65	18	6	27.88	● 104060			
28	1.5	65	18	6	27.85	● 104061			
30	1	65	18	7	29.88	● 104073			
30	1.5	65	18	6	29.85	● 104074			
30	2	65	18	6	29.82	● 104076			
32	1.5	65	18	7	31.85	● 104082	* 104083		
33	1.5	65	18	7	32.85	● 104085			
33	2	65	18	7	32.82	● 104086			
34	1.5	65	18	7	33.85	● 104091			
35	1.5	65	18	8	34.85	● 104092			
36	1.5	65	18	8	35.85	● 104095			
36	2	65	18	8	35.82	● 104097			
36	3	65	25	7	35.76	● 104099			
38	1.5	75	20	7	37.85	● 104101			
39	1.5	75	20	7	38.85	● 104104			
40	1.5	75	20	8	39.85	● 104118			
40	2	75	20	7	39.82	● 104120			
42	1.5	75	20	8	41.85	● 104122			
42	3	75	20	8	41.76	● 104125			
45	1.5	90	22	7	44.85	● 104127			
45	2	90	22	7	44.82	● 104129			
48	1.5	90	22	8	47.85	● 104133	* 104134		
48	2	90	22	8	47.82	● 104135			
48	3	90	22	7	47.76	● 104137			
50	1.5	90	22	8	49.85	● 104150			
60	2	105	22	9	59.82	● 104168			



N5110							N5110	N5120		
$\emptyset$ " $d_1$ UNC	P TPI	$d_1$ mm	$d_2$ mm	$l_1$ mm			ID	ID		
1	64	1.85	16	5	3	1.79	● 103893			
2	56	2.18	16	5	4	2.12	● 103894			
3	48	2.51	16	5	4	2.44	● 103895			
4	40	2.84	16	5	4	2.76	● 103896			
5	40	3.17	20	5	4	3.09		● 104263		
6	32	3.5	20	7	4	3.41		● 104266		
8	32	4.16	20	7	4	4.07		● 104269		
10	24	4.82	20	7	4	4.71		● 104258		
12	24	5.48	20	7	4	5.37		● 104259		
1/4	20	6.35	20	7	4	6.22		● 104256		
5/16	18	7.93	25	9	4	7.8		● 104264		
3/8	16	9.52	30	11	4	9.37		● 104262		
7/16	14	11.11	30	11	4	10.95		● 104267		
1/2	13	12.7	38	14	4	12.52		● 111387		
9/16	12	14.28	38	14	4	14.1		● 104270		
5/8	11	15.87	45	18	4	15.68		● 104265		
3/4	10	19.05	45	18	5	18.84		● 104261		
7/8	9	22.22	55	22	5	22		● 104268		
1	8	25.4	55	22	5	25.16		● 104257		
1 1/4	7	31.75	65	25	6	31.49		● 104251		
1 1/2	6	38.1	75	30	6	37.81		● 104250		
2	4.5	50.8	90	36	7	50.45		★ 104260		

							N5110	N5120		
<p>N5110 </p> <p>N5120  </p>										
Ø" d <sub>1</sub> UNF	P TPI	d <sub>1</sub> mm	d <sub>2</sub> mm	l <sub>1</sub> mm			ID	ID		
0	80	1.52	16	5	3	1.47	● 103897			
1	72	1.85	16	5	3	1.79	● 103898			
2	64	2.18	16	5	4	2.12	● 103899			
3	56	2.51	16	5	4	2.44	● 103900			
4	48	2.84	16	5	4	2.77	● 103901			
5	44	3.17	20	5	4	3.1		● 104299		
6	40	3.5	20	5	4	3.42		● 104302		
8	36	4.16	20	7	4	4.08		● 104305		
10	32	4.82	20	7	4	4.73		● 104295		
12	28	5.48	20	7	4	5.38		● 104296		
1/4	28	6.35	20	7	4	6.24		● 104293		
5/16	24	7.93	25	9	4	7.82		● 104300		
3/8	24	9.52	30	11	4	9.41		● 104298		
7/16	20	11.11	30	11	5	10.98		● 104303		
1/2	20	12.7	38	10	5	12.56		● 104292		
9/16	18	14.28	38	10	5	14.14		● 104306		
5/8	18	15.87	45	14	5	15.73		● 104301		
3/4	16	19.05	45	14	6	18.89		● 104297		
7/8	14	22.22	55	16	5	22.05		● 104304		
1	12	25.4	55	16	6	25.21		● 104294		
1 1/4	12	31.75	65	18	7	31.56		● 104289		
1 1/2	12	38.1	75	20	7	37.91		● 111390		

# UNEF, UNS, UN ASME B1.1

HSS

DIN EN 22568













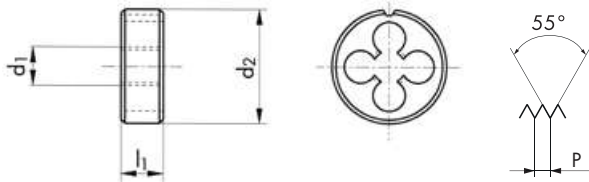

N5120							N5120			
$\emptyset'' d_1$ UNEF	P TPI	$d_1$ mm	$d_2$ mm	$l_1$ mm			ID			
12	32	5.48	20	7	4	5.39	● 104278			
1/4	32	6.35	20	7	4	6.25	● 104275			
5/16	32	7.93	25	9	4	7.84	● 104283			
3/8	32	9.52	30	11	4	9.42	● 104282			
7/16	28	11.11	30	11	5	11	● 104285			
1/2	28	12.7	38	10	5	12.59	● 104274			
9/16	24	14.28	38	10	5	14.17	● 104287			
5/8	24	15.87	45	14	5	15.75	● 104284			
3/4	20	19.05	45	14	6	18.91	● 104281			
$\emptyset'' d_1$ UNS	P TPI	$d_1$ mm	$d_2$ mm	$l_1$ mm			ID			
1/4	40	6.35	20	5	4	6.26	● 104309			
1/4	36	6.35	20	5	4	6.26	● 104308			
7/16	24	11.11	30	11	5	10.99	● 104311			
1/2	24	12.7	38	10	5	12.58	● 104307			
1	14	25.4	55	16	6	25.23	● 104310			
$\emptyset'' d_1$ UN	P TPI	$d_1$ mm	$d_2$ mm	$l_1$ mm			ID			
1 1/8	8	28.57	65	25	5	28.33	● 104246			
1 1/4	8	31.75	65	25	6	31.51	● 104245			
1 1/2	8	38.1	75	20	7	37.85	● 104244			
1 3/4	8	44.45	90	22	7	44.2	● 104247			

# G DIN EN ISO 228 (BSP)

HSS



							N5120	N5120 LH		
<p>N5120  </p> <p>N5120 LH   </p>										
							 		 	
$\frac{\text{Ø}''}{\text{G}}$	P TPI	$d_1$ mm	$d_2$ mm	$l_1$ mm			ID	ID		
1/8	28	9.7	30	11	5	9.62	● 103926			
1/4	19	13.15	38	10	5	13.03	● 103924	● 103925		
3/8	19	16.66	45	14	5	16.54	● 103935	● 103936		
1/2	14	20.95	45	14	6	20.81	● 103922	● 103923		
5/8	14	22.91	55	16	5	22.77	● 103938			
3/4	14	26.44	55	16	6	26.3	● 103933	● 103934		
7/8	14	30.2	65	18	6	30.06	● 103940			
1	11	33.24	65	18	7	33.07	● 103928			
1 1/4	11	41.91	75	20	8	41.73	● 103918			
1 1/2	11	47.8	90	22	8	47.62	● 103917			
2	11	59.61	105	22	9	59.43	● 103932			
2 1/2	11	75.18	120	22	10	74.97	● 103930			









# G DIN EN ISO 228 (BSP)

Z MS  
HSSE HSS

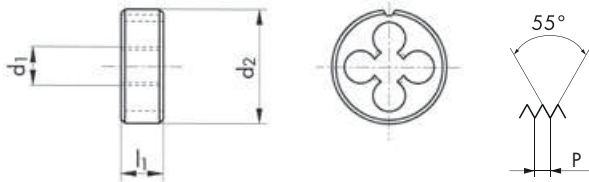







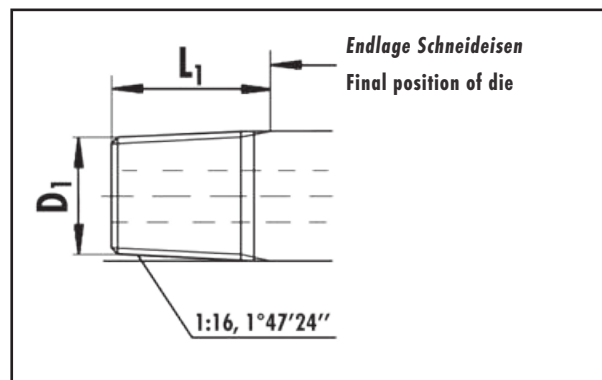







Z5120		NI	13	14	21	Z5120	MS5120	MS5120		
MS5120										
MS5120										
$\emptyset'' d_1$ G	P TPI	d <sub>1</sub> mm	d <sub>2</sub> mm	l <sub>1</sub> mm	Z	MS	$\rightarrow A \leftarrow$	ID	ID	ID
1/8	28	9.72	30	11	5	5	9.62	● 104761		★ 142831
1/4	19	13.15	38	10	5	5	13.03	● 104760	● 101338	★ 142832
3/8	19	16.66	45	14	5	5	16.54	● 104764	● 101342	● 119716
1/2	14	20.95	45	14	6	6	20.81	● 104759	● 101337	● 119243
3/4	14	26.44	55	16	6	6	26.3	● 104763	● 101341	● 119648
1	11	33.24	65	18	8	7	33.07	● 104762	● 101340	● 135186

<b>N5120</b>  					<b>N5120</b>
					
					 
$\emptyset'' d_1$	P	$d_2$	$l_1$		<b>ID</b>
R	TPI	mm	mm		
1/8	28	30	11	5	● 104226
1/4	19	38	14	5	● 104225
3/8	19	45	14	5	● 104230
1/2	14	45	18	6	● 104224
3/4	14	55	22	6	● 104229
1	11	65	25	7	● 104227

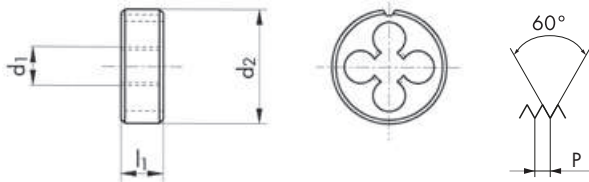
**Richtwerte für Drehdurchmesser für R-Gewinde (in mm)**  
**Guide values for turning diameters for R-threads (in mm)**



$\emptyset''$ R	$D_1$ mini mm	$D_1$ maxi mm	$D_1$ (guide line) mm	$L_1$ (guide line) mm
1/8	9.422	9.534	9.48	8.2
1/4	12.700	12.863	12.78	12.1
3/8	16.181	16.343	16.26	12.5
1/2	20.330	20.555	20.44	16.4
3/4	25.735	25.960	25.85	17.7
1	32.455	32.743	32.60	20.9

<p>N5120    </p>					N5120	N5120		
<p>N5120    </p>					<p>NPT NPTF</p> 			
					 		 	
Ø" d <sub>1</sub> NPT, NPTF	P TPI	d <sub>2</sub> mm	l <sub>1</sub> mm		ID	ID		
1/16	27	25	9	4	● 104194			
1/8	27	30	11	5	● 104197			
1/4	18	38	14	5	● 104196			
3/8	18	45	14	5	● 104201			
1/2	14	45	18	6	● 104195	* 104205		
3/4	14	55	22	6	● 104200			
1	11.5	65	25	7	● 104198	* 104208		
1 1/4	11.5	75	26	8	● 104193			

**Richtwerte für Drehdurchmesser für NPT- und NPTF-Gewinde (in mm)**  
**Guide values for turning diameters for NPT and NPTF-threads (in mm)**

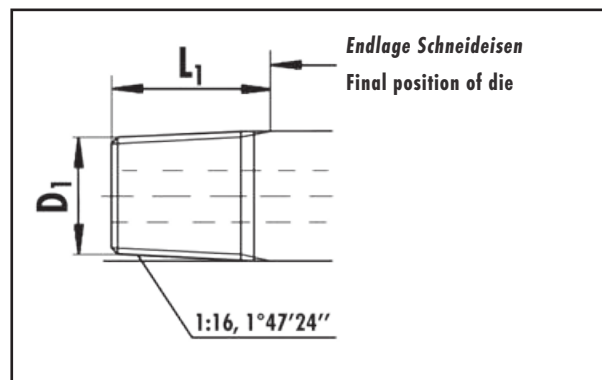

Ø" NPT	D <sub>1</sub> mini mm	D <sub>1</sub> maxi mm	D <sub>1</sub> (guide line) mm	L <sub>1</sub> (guide line) mm	Ø" NPTF	D <sub>1</sub> mini mm	D <sub>1</sub> maxi mm	D <sub>1</sub> (guide line) mm	L <sub>1</sub> (guide line) mm
1/16	7.521	7.643	7.58	8.4	1/16	7.525	7.617	7.57	8.4
1/8	9.866	9.988	9.93	8.5	1/8	9.870	9.962	9.92	8.5
1/4	13.099	13.255	13.18	12.7	1/4	13.129	13.215	13.17	12.7
3/8	16.518	16.674	16.60	12.9	3/8	16.548	16.634	16.59	12.9
1/2	20.551	20.713	20.63	16.8	1/2	20.617	20.703	20.66	16.8
3/4	25.866	26.028	25.95	17.1	3/4	25.932	26.018	25.98	17.1
1	32.419	32.591	32.51	21.3	1	32.475	32.561	32.52	21.3
1 1/4	41.144	41.316	41.23	21.9					

# PG DIN 40430 TR DIN 103

HSS















N5120							N5120	N5120			
							<div style="display: flex; justify-content: space-around;"> <div style="border: 1px solid black; padding: 5px;">PG</div> <div style="border: 1px solid black; padding: 5px;">TR</div> </div>				
$\emptyset d_1$ PG	P TPI	$d_1$ mm	$d_2$ mm	$l_1$ mm			ID				
7	20	12.5	38	10	5	12.4	● 104220				
9	18	15.2	38	10	5	15.1	● 104221				
11	18	18.6	45	14	5	18.5	● 104212				
13.5	18	20.4	45	14	6	20.3	● 104213				
16	18	22.5	55	16	5	22.4	● 104214				
42	16	54	90	22	10	53.85	* 104218				
48	16	59.3	105	22	9	59.15	* 104219				
Other sizes on request!											
							<div style="border: 1px solid black; padding: 5px; width: fit-content; margin: 0 auto;">7e</div>				
$\emptyset d_1$ TR	P mm	$d_2$ mm	$l_1$ mm			ID					
28	5	65	25	5	27.83	* 104240					
32	6	65	25	6	31.81	* 104242					
Other sizes on request!											

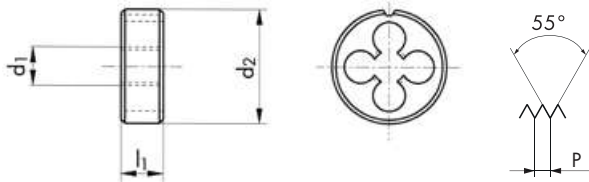

















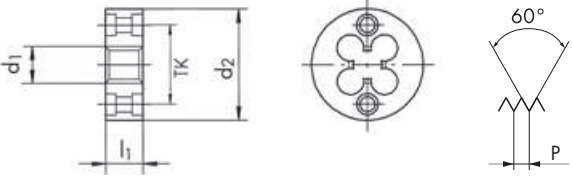

# W BS 84 (BSW)

HSS



							N5120	N5120 LH		
<p>N5120  </p> <p>N5120 LH   </p>										
							 		 	
$\emptyset$ W	$d_1$	P	$d_2$	$l_1$			ID	ID		
1/8	40	3.17	20	5	4	3.09	● 104320			
5/32	32	3.96	20	7	4	3.88	● 104333			
3/16	24	4.76	20	7	4	4.66	● 104325			
1/4	20	6.35	20	7	4	6.24	● 104318			
5/16	18	7.93	25	9	4	7.82	● 104331			
3/8	16	9.52	30	11	4	9.4	● 104329			
7/16	14	11.11	30	11	4	10.98	● 104336			
1/2	12	12.7	38	14	4	12.56	● 104316			
5/8	11	15.87	45	18	4	15.72	● 104334			
3/4	10	19.05	45	18	5	18.89	● 104327	* 104328		
1	8	25.4	55	22	5	25.27	● 104322			
1 3/8	6	34.92	65	25	6	34.77	* 104315			











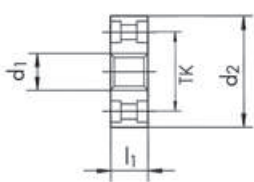

								N5220	N5220	Z5220	
<p><b>N5220</b>   </p> <p><b>N5220</b>   </p> <p><b>Z5220</b>    </p>											
											
											
$\emptyset d_1$ M	P mm	$d_2$ mm	$l_1$ mm		TK mm			ID	ID	6g - mm	ID
1.4	0.3	16	2.6	4	12.2	1.36		● 104346			
1.6	0.35	16	2.6	4	12.2	1.54		● 104347			
2	0.4	16	3.5	4	12.2	1.93		● 104367			
2.3	0.4	16	3.5	4	12.2	2.23		● 104369			
2.5	0.45	16	3.5	4	12.2	2.43		● 104371		● 104803	
2.6	0.45	16	3.5	4	12.2	2.53		● 104372			
3	0.5	16	3.5	4	12.2	2.92	2.9	● 104375	● 104374	0.030	● 104804
3.5	0.6	16	4	4	12.2	3.41		● 104376			
4	0.7	16	5	4	12.2	3.91	3.87	● 104380	● 104379	0.035	● 104805
5	0.8	20	7	4	15	4.9	4.87	● 104384	● 104383	0.035	● 104806
6	1	20	7	4	15	5.88	5.85	● 104388	● 104387	0.035	● 104807
8	1.25	25	9	4	19	7.87	7.83	● 104397	● 104396	0.035	● 104808
10	1.5	30	11	6	23	9.85	9.82	● 104354	● 104353	0.035	
12	1.75	30	11	6	23	11.83		● 104358			

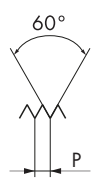
≤ M1.4

6h



<b>N5220</b>   							<b>N5220</b>	
  								
								
Ø d <sub>1</sub> MF	P mm	d <sub>2</sub> mm	l <sub>1</sub> mm		TK mm	 6g	ID	
3	0.35	16	3	4	12.2	2.94	● 104373	
4	0.5	16	4	4	12.2	3.93	● 104378	
5	0.5	20	5	4	15	4.93	● 104382	
6	0.5	20	5	4	15	5.93	● 104385	
6	0.75	20	7	4	15	5.9	● 104386	
7	0.5	25	7	4	19	6.93	* 104389	
7	0.75	25	7	4	19	6.9	* 104390	
10	0.75	30	7	6	23	9.9	* 104350	
10	1.25	25	9	6	19	9.86	* 104352	

N5310						N5310			
$\emptyset d_1$ M	P mm	s mm	$l_1$ mm		 →6g←	ID			
3	0.5	18	5	3	2.92	● 104464			
3.5	0.6	18	5	3	3.41	★ 104465			
4	0.7	18	5	3	3.91	● 104478			
4.5	0.75	18	7	3	4.41	★ 104479			
5	0.8	18	7	4	4.9	● 104487			
6	1	18	7	4	5.88	● 104493			
8	1.25	21	9	4	7.87	● 104502			
9	1.25	21	9	5	8.87	★ 104503			
10	1.5	27	11	4	9.85	● 104438			
12	1.75	36	14	4	11.83	● 104443			
14	2	36	14	4	13.82	● 104445			
16	2	41	18	4	15.82	● 104447			
18	2.5	41	18	5	17.79	● 104450			
20	2.5	41	18	5	19.79	● 104453			
22	2.5	50	22	5	21.79	● 104456			
24	3	50	22	5	23.76	● 104459			
30	3.5	60	25	5	29.73	● 104468			
$\emptyset d_1$ MF	P mm	s mm	$l_1$ mm		 →6g←	ID			
6	0.75	18	7	4	5.9	★ 104492			
8	0.75	21	9	4	7.9	★ 104500			
8	1	21	9	4	7.88	★ 104501			
12	1	36	10	4	11.88	★ 104440			
27	1.5	60	18	6	26.85	★ 104461			
33	1.5	60	18	7	32.85	★ 104469			
39	1.5	70	20	8	38.85	★ 104476			



**G** DIN EN ISO 228 (BSP)

**W** BS 84 (BSW)

**M** ISO DIN 13

HSS



							N5310	N5310		N5420		
N5310												
N5310												
N5420												
$\emptyset$ " d <sub>1</sub>	P	d <sub>1</sub>	s	l <sub>1</sub>			ID					
G	TPI	mm	mm	mm		$\rightarrow A \leftarrow$						
1/4	19	13.15	36	10	5	13.03	● 104428					
3/8	19	16.66	41	14	5	16.54	● 104433					
1/2	14	20.95	41	14	6	20.81	● 104427					
5/8	14	22.91	50	16	6	22.77	★ 104434					
3/4	14	26.44	50	16	6	26.3	● 104432					
7/8	14	30.2	60	18	6	30.06	★ 104435					
1	11	33.24	60	18	7	33.07	● 104430					
1 3/8	11	44.32	85	22	7	44.14	★ 104426					
1 3/4	11	53.74	100	22	8	53.57	★ 104425					
$\emptyset$ " d <sub>1</sub>	P	d <sub>1</sub>	s	l <sub>1</sub>			ID					
W	TPI	mm	mm	mm		$\rightarrow MC \leftarrow$						
1/8	40	3.17	18	5	3	3.09	★ 104512					
3/16	24	4.76	18	7	3	4.66	★ 104515					
9/16	12	14.28	36	14	4	14.14	★ 104522					
1 3/8	6	34.92	60	25	6	34.77	★ 104508					
1 1/2	6	38.1	70	30	6	37.95	★ 104504					
1 3/4	5	44.45	85	36	6	44.28	★ 104507					
2	4.5	50.8	85	36	7	50.63	★ 104514					
$\emptyset$ d <sub>1</sub>	P	d <sub>2</sub>	l <sub>1</sub>			ID						
M	mm	mm	mm		$\rightarrow 6g \leftarrow$							
2.5	0.45	16	8	4	2.43	★ 104527						
3.5	0.6	16	9.5	4	3.41	★ 104530						
8	1.25	25	14	5	7.86	★ 104535						

# PRÄZISIONS-GEWINDELEHREN — PRECISION THREAD GAUGES

## D5703



**DC-Grenz-Gewindelehrdorn mit Gut- und Ausschusseite**  
Baumasse nach DIN 2280 bis Nenndurchmesser 40 mm

**DC "Go" / "No-Go" thread plug gauge**

Dimensions according to DIN 2280 till nominal diameter 40 mm

## D5701-1



**DC-Gut-Gewindelehrdorn**

Baumasse nach DIN 2281-1;

über Nenndurchmesser 40 mm nach DIN 2281-2

**DC "Go" thread plug gauge**

dimensions according to DIN 2281-1;

above nominal diameter of 40 mm as per DIN 2281-2

## D5701-2



**DC-Ausschuss-Gewindelehrdorn**

Baumasse nach DIN 2283-1;

über Nenndurchmesser 40 mm nach DIN 2283-2

**DC "No-Go" thread plug gauge**

dimensions according to DIN 2283-1;

above nominal diameter of 40 mm as per DIN 2283-2

## D5720



**DC-Grenz-Gewindelehrdorn kegelig**

mit Messstufe

**DC "Go" / "No-Go" thread plug gauge conical**

with step limit

### Wichtiger Hinweis

DC SWISS SA ist spezialisiert für die Herstellung von Gewindelehrdornen mit extrem feinen Gewinden, wie sie häufig in der Uhrenindustrie zum Einsatz kommen, speziell für die Kontrolle von Innengewinden in Uhrengehäusen.

Auf Anfrage unterbreiten wir Ihnen gerne ein entsprechendes Angebot.

### Important note

DC SWISS SA is specialised in the manufacture of thread plug gauges with extremely fine threads, such as those frequently used in the watchmaking industry, especially for checking internal threads in watch cases.

On request, we will be pleased to submit you an appropriate quotation.



# PRÄZISIONS-GEWINDELEHREN — PRECISION THREAD GAUGES

## D5704



### **DC-Gut-Gewindelehrring**

Baumasse nach DIN 2285-1

### **DC "Go" thread ring gauge**

dimensions according to DIN 2285-1

## D5714



### **DC-Ausschuss-Gewindelehrring**

Baumasse nach DIN 2299-1

### **DC "No-Go" thread ring gauge**

dimensions according to DIN 2299-1

## D5721



### **DC-Grenz-Gewindelehrring, für kegeliges Aussengewinde mit Messstufe**

**DC "Go" / "No-Go" thread ring gauge for tapered external thread  
with step limit**

Gewindelehren ab Lager lieferbar ohne Prüfzertifikat.

Auf Wunsch können diese Gewindelehren kurzfristig mit Prüfzertifikat geliefert werden, Preis für Prüfzertifikat auf Anfrage.

Für neue Gewindelehren (Neulieferung) / Messunsicherheit U95.

Alle zertifizierten Gewindelehren werden mit der auf dem entsprechenden Prüfzertifikat aufgeführten Ident-Nummer beschriftet.













Thread gauges available from stock without test certificate.

However, all gauges can be delivered in short time with test certificate on demand, price for the certificate on request.

For new ordered thread gauges / measuring uncertainty U95.

All "certified" thread gauges will be marked with the identity number of the corresponding test certificate.

**Inhaltsverzeichnis — Gewindelehrdorne und Gewindelehrringe**  
**Directory — Screw thread plug and ring gauges**

<b>Merkmale</b> <b>Characteristics</b>							
							
<b>Typ</b> <b>Type</b>		<b>D5701-1</b>	<b>D5701-2</b>	<b>D5703</b>	<b>D5720</b>	<b>D5722</b>	<b>D5725</b>
<b>M 6H / 6g</b>	ISO DIN 13	294	294	294			
<b>M 6G / 6e</b>	ISO DIN 13			294			
<b>M 6H / 6g LH</b>	ISO DIN 13			294			
<b>MF 6H / 6g</b>	ISO DIN 13	296 - 297	297	296 - 297			
<b>MF 6G / 6e</b>	ISO DIN 13			296			
<b>MF 6H / 6g LH</b>	ISO DIN 13			296			
<b>UNC</b>	ASME B1.1	300		300			
<b>UNF</b>	ASME B1.1	301		301			
<b>UNEF</b>	ASME B1.1			301			
<b>NPT</b>	ASME B1.20.1				303		
<b>NPTF</b>	ANSI B1.20.3				303		
<b>G (BSP)</b>	DIN EN ISO 228	302	302	302			
<b>PG</b>	DIN 40430						302
<b>EG M</b>	ISO DIN 8140			304			
<b>EG UNC</b>	ASME B18.29.1			304			
<b>EG UNF</b>	ASME B18.29.1			304			

## Piktogramme - Pictographs

	"Gut" "Go"
	"Ausschuss" "No-Go"
	"Gut" / "Ausschuss" "Go" / "No-Go"
	Toleranz 6H, "Gut" Tolerance 6H, "Go"
	Toleranz 6G, "Gut" / "Ausschuss" Tolerance 6G, "Go" / "No-Go"
	Toleranz 6g, "Ausschuss" Tolerance 6g, "No-Go"
	Linksgewinde Left-hand thread

Gewindelehren ab Lager lieferbar ohne Prüfzertifikat.

Auf Wunsch können diese Gewindelehren kurzfristig mit Prüfzertifikat geliefert werden, Preis für Prüfzertifikat auf Anfrage.

Für neue Gewindelehren (Neulieferung) / Messunsicherheit U95.

Alle zertifizierten Gewindelehren werden mit der auf dem entsprechenden Prüfzertifikat aufgeführten Ident-Nummer beschriftet.

Thread gauges available from stock without test certificate.













However, all gauges can be delivered in short time with test certificate on demand, price for the certificate on request.

For new ordered thread gauges / measuring uncertainty U95.

All "certified" thread gauges will be marked with the identity number of the corresponding test certificate.

<b>D5704</b>	<b>D5714</b>	<b>D5721</b>	<b>D5723</b>
295	295		
295	295		
295			
298 - 299	298 - 299		
298			
300	300		
301	301		
301	301		
		303	
		303	
302	302		
302			

# M ISO DIN 13 DIN ISO 1502

		D5701-1	D5701-2	D5703	D5703 LH	D5703	
D5701-1	M1 - M1.4 = 						
D5703	M1 - M1.4 = 				 		
$\emptyset d_1$ M	P mm	ID	ID	ID	ID	ID	
1	0.25			● 100242			
1.1	0.25			● 100243			
1.2	0.25			● 100244			
1.4	0.3			● 100245			
1.6	0.35			● 100246			
1.7	0.35			● 100247			
1.8	0.35			● 100248			
2	0.4			● 100278	● 105159	● 104982	
2.2	0.45			● 100280			
2.3	0.4			● 100281			
2.5	0.45			● 100283	● 105160	● 104979	
2.6	0.45			● 100285			
3	0.5			● 100310	● 104964	● 104976	
3.5	0.6			● 100312		● 104977	
4	0.7			● 100333	● 104966	● 104978	
4.5	0.75	* 100114					
5	0.8			● 100348	● 104967	● 104980	
6	1			● 100363	● 104968	● 104981	
7	1			● 100369			
8	1.25			● 100373	● 104969	● 104983	
9	1.25			● 100375			
10	1.5			● 100253	● 104970	● 104984	
11	1.5			* 100256			
12	1.75			● 100261	● 104971	● 104985	
14	2	* 100045		● 100266		● 104986	
16	2			● 100271	● 104973	● 104987	
18	2.5	* 100055		● 100276		* 104988	
20	2.5	* 100068		● 100289	● 104975	● 104989	
22	2.5	* 100072		● 100293	* 110178		
24	3	* 100076		● 100297	● 110179		
27	3			● 100305			
30	3.5			● 100316			
33	3.5	* 100101		● 100322			
36	4	* 100107		● 100328			
39	4	* 100109		● 100330			
42	4.5	● 100119	● 142843				
45	4.5	● 100122	● 142844				
48	5	● 100125	● 142845				
52	5	● 100132	● 142846				
56	5.5	● 100137	● 142847				

# M ISO DIN 13 DIN ISO 1502





		D5704	D5704 LH	D5704	D5714	D5714	
D5704	M1 - M1.4 = <span style="border: 1px solid black; padding: 2px;">6h</span>						
D5714	M1 - M1.4 = <span style="border: 1px solid black; padding: 2px;">6h</span>		<span style="border: 1px solid black; padding: 2px;">6g</span>	<span style="border: 1px solid black; padding: 2px;">6g</span> LH	<span style="border: 1px solid black; padding: 2px;">6e</span>	<span style="border: 1px solid black; padding: 2px;">6g</span>	<span style="border: 1px solid black; padding: 2px;">6e</span>
Ø d <sub>1</sub> M	P mm	ID	ID	ID	ID	ID	
1	0.25	● 100480			● 110419		
1.2	0.25	● 100481			● 110420		
1.4	0.3	● 100482			● 110421		
1.6	0.35	● 100483			● 110422		
1.7	0.35	● 100484			● 111439		
1.8	0.35	● 100485			● 110423		
2	0.4	● 100515	● 105006		● 100734		
2.2	0.45	● 100517			● 100735		
2.3	0.4	● 100518			● 100736		
2.5	0.45	● 100520			● 100737		
2.6	0.45	● 100522			● 100738		
3	0.5	● 100547	● 105001		● 100763		
3.5	0.6	● 100549	● 110302	* 110301	● 100765	* 142836	
4	0.7	● 100570	● 105003		● 100774		
5	0.8	● 100585	● 105004	* 104993	● 100778	* 143406	
6	1	● 100600	● 105005	* 104994	● 100781	* 135556	
7	1	● 100605		* 104995	● 100783		
8	1.25	● 100611	● 105007		● 100786		
9	1.25	● 100610			● 100788		
10	1.5	● 100490	● 105008		● 100711	* 142842	
11	1.5				* 100713		
12	1.75	● 100498	● 105009		● 100718		
14	2	● 100503	● 105010		● 100723		
16	2	● 100508	● 105011		● 100728		
18	2.5	● 100513	● 105012		● 100733		
20	2.5	● 100526	● 105013		● 100742		
22	2.5	● 100530	● 110298		● 100746		
24	3	● 100534			● 100750		
27	3	● 100542			● 100758		
30	3.5	● 100553			● 100769		
33	3.5	* 100559			* 100770		
39	4				* 110440		
45	4.5				* 110448		
56	5.5	* 100595			* 110461		

# MF ISO DIN 13 DIN ISO 1502

		D5701-1	D5703	D5703 LH	D5703		
		<b>6H</b>	<b>6H</b>	<b>6H</b>	<b>LH</b>	<b>6G</b>	
$\emptyset d_1$ MF	P mm	ID	ID	ID	ID		
2.5	0.35		● 100282				
3	0.35		● 100309				
4	0.35		● 100331				
4	0.5		● 100332				
5	0.5		● 100347	● 105016	● 105045		
6	0.5	* 100140	● 100361	● 110184			
6	0.75		● 100362		● 105046		
7	0.5		● 100367				
7	0.75	* 100147	● 100368				
8	0.5	* 100149	● 100370				
8	0.75		● 100371	● 105018	● 105047		
8	1	* 100151	● 100372	● 105019	● 105048		
9	1		● 100374				
10	0.5		● 100249				
10	0.75		● 100250				
10	1		● 100251	● 105020	● 105049		
10	1.25	* 100031	● 100252				
11	1	* 100034	● 100255				
12	0.75	* 100036	● 100257				
12	1		● 100258	● 105021	● 105050		
12	1.25		● 100259				
12	1.5		● 100260	● 105022			
14	1		● 100263	● 110171			
14	1.25		● 100264				
14	1.5		● 100265	● 105023	● 105052		
15	1		● 100267				
15	1.5		● 100268				
16	1		● 100269	● 110172			
16	1.5		● 100270	● 105024	● 105053		
17	1		● 100272				
18	1		● 100273				
18	1.5		● 100274	● 105025	● 105054		
18	2	* 100054	● 100275				
20	1	* 100065	● 100286				
20	1.5		● 100287	● 105026			
20	2	* 100067	● 100288		* 110176		
22	1		● 100290				
22	1.5		● 100291	● 110177			
22	2		● 100292				
24	1		● 100294				
24	1.5		● 100295				
24	2		● 100296				



# MF ISO DIN 13 DIN ISO 1502

		D5701-1	D5701-2	D5703			
							
							
$\emptyset d_1$ MF	P mm	ID	ID	ID			
25	1			● 100298			
25	1.5			● 100299			
25	2			● 100300			
26	1			● 100301			
26	1.5	* 100081		● 100302			
27	1.5	* 100082		● 100303			
27	2	* 100083		● 100304			
28	1			● 100306			
28	1.5	* 100086		● 100307			
28	2	* 100087		● 100308			
30	1	* 100092		● 100313			
30	1.5			● 100314			
30	2			● 100315			
32	1			● 100317			
32	1.5			● 100318			
32	2			● 100319			
33	1.5			● 100320			
33	2			● 100321			
35	1.5			● 100323			
36	1.5			● 100325			
36	2			● 100326			
36	3			● 100327			
38	1.5	* 100108		● 100329			
40	1.5			● 100336			
40	2			● 100337			
42	1.5	● 100117	● 142848				
42	2	● 100118	● 142849				
45	1.5	● 100120	● 110127				
45	2	● 100121	● 142851				
48	1.5	● 100123	● 123180				
48	2	● 100124	● 142853				
50	1.5	● 100128	● 142854				
50	2	● 100129	● 142855				
52	1.5	● 100130	● 123428				
52	2	● 100131	● 142857				
55	1.5		● 123468				
55	2	● 100134	● 142859				
56	1.5	● 100135	● 142860				
56	2	● 100136	● 142861				
58	1.5	● 100138	● 142862				
58	2	● 100139	● 142863				
60	1.5	● 100143	● 142864				
60	2	● 100144	● 142865				

		D5704	D5704 LH	D5714			
							
		6g	6g LH	6g			
Ø d <sub>1</sub> MF	P mm	ID	ID	ID			
2.5	0.35	● 100519		● 110427			
3	0.35	● 100546		● 100762			
3.5	0.35	● 100548		● 100764			
4	0.35	● 100568		● 100772			
4	0.5	● 100569		● 100773			
4.5	0.5	● 100571		● 100775			
5	0.5	● 100584	● 105057	● 100777			
6	0.5	● 100598	● 110307	● 100779			
6	0.75	● 100599	● 105058	● 100780			
7	0.5	● 100603		● 110467			
7	0.75	● 100604		● 100782			
8	0.5	● 100606					
8	0.75	● 100607	* 105059	● 100784			
8	1	● 100608	● 105060	● 100785			
9	1	● 100609		● 100787			
10	0.5	● 100486		● 100707			
10	0.75	● 100487		● 100708			
10	1	● 100488	● 105061	● 100709			
10	1.25	● 100489		● 100710			
11	1	● 100492		● 100712			
12	0.75	● 100494		● 100714			
12	1	● 100495	● 105062	● 100715			
12	1.25	● 100496		● 100716			
12	1.5	● 100497	● 105063	● 100717			
13	1	● 100499		● 100719			
14	1	● 100500	● 110290	● 100720			
14	1.25	● 100501		● 100721			
14	1.5	● 100502	● 105064	● 100722			
15	1	● 100504		● 100724			
15	1.5	● 100505		● 100725			
16	1	● 100506	● 110292	● 100726			
16	1.5	● 100507	● 105065	● 100727			
17	1	● 100509		● 100729			
18	1	● 100510		● 100730			
18	1.5	● 100511	● 105066	● 100731			
20	1	● 100523	● 110295	● 100739			
20	1.5	● 100524	● 105067	● 100740			
20	2	● 100525		● 100741			
22	1	● 100527		● 100743			
22	1.5	● 100528		● 100744			
22	2	● 100529		● 100745			
24	1	● 100531		● 100747			
24	1.5	● 100532		● 100748			
24	2	● 100533					

		D5704	D5714				
							
		6g	6g				
$\varnothing d_1$ MF	P mm	ID	ID				
25	1	● 100535					
25	1.5	● 100536					
26	1	● 100538					
26	1.5	● 100539					
27	1.5	● 100540					
27	2	● 100541	* 100757				
28	1	● 100543					
28	1.5	● 100544	* 100760				
30	1	● 100550					
30	1.5	● 100551					
30	2	● 100552					
32	1	● 100554					
32	1.5	● 100555					
32	2	● 100556					
33	1.5	● 100557					
33	2	● 100558	* 110433				
35	1.5	● 100560					
36	1.5	● 100562					
36	2	● 100563					
36	3	● 100564					
38	1.5	● 100566					
40	1.5	● 100573					
42	1.5	● 100575					
42	2	● 100576					
45	1.5	● 100578					
45	2	● 100579					
48	1.5	● 100581	* 110449				
48	2	● 100582					
50	1.5	● 100586					
50	2	● 100587	* 110453				
52	1.5		* 110454				
52	2	● 100589					
55	1.5	● 100591					
55	2	● 100592	* 110458				
56	1.5	● 100593	* 110459				
56	2		* 110460				
58	1.5	● 100596					
58	2	● 100597	* 110463				
60	1.5	● 100601					
60	2	● 105014					

		D5701-1	D5703	D5704	D5714		
Ø" d <sub>1</sub> UNC	P TPI	ID	ID	ID	ID		
1	64		● 100408	● 110347	● 110473		
2	56		● 100414	● 110353	● 110479		
3	48		● 100416				
4	40	* 110080	● 110224	● 110357	● 110483		
5	40		● 100420				
6	32	* 110084	● 100423	● 110361	● 110487		
8	32		● 100426	● 110364	● 110490		
10	24	* 110074	● 100412	● 110351	● 110477		
12	24		● 100413				
1/4	20		● 100410	● 110349	● 110475		
5/16	18	* 110082	● 100421	● 110359	● 110485		
3/8	16	* 110079	● 100418	● 110356	● 110482		
7/16	14	* 110085	● 100424	● 110362	● 110488		
1/2	13	* 110071	● 100409	● 110348	● 110474		
9/16	12		● 100427	● 110365	* 110491		
5/8	11		● 100422	● 110360			
3/4	10	* 110078	● 100417	● 110355	* 110481		
7/8	9		● 100425	● 110363	* 110489		
1	8	* 110073	● 100411	● 110350	* 110476		
1 1/8	7	* 110068	● 100405	* 110345	* 110471		
1 1/4	7	* 110067	● 100404	* 110344	* 110470		
1 3/8	6	* 110069	● 100407	* 110346	* 110472		
1 1/2	6	* 110066	● 100403	* 110343	* 110469		













# UNF, UNEF

ASME B1.1  
ANSI / ASME B1.2

		D5701-1	D5703	D5704	D5714		
$\varnothing'' d_1$ UNF	P TPI	ID	ID	ID	ID		
0	80		● 110246				
1	72		● 110251	● 110383	● 110508		
2	64		● 110256	● 110389	● 110514		
3	56		● 110257	● 110390	● 110515		
4	48		● 110260	● 110393	● 110518		
5	44	* 110116					
6	40		● 110264				
8	36	* 110122	● 110267				
10	32		● 110254	● 110387	● 110512		
12	28		● 110255	● 110388	● 110513		
1/4	28	* 110107	● 110006	● 110385	● 110510		
5/16	24	* 110117	● 110262	● 110395	● 110520		
3/8	24	* 110114	● 110259	● 110392	● 110517		
7/16	20	* 110120	● 110265	● 110398	● 111440		
1/2	20	* 110106	● 110252	● 110384	● 110509		
9/16	18		● 110268	● 110401			
5/8	18		● 110263	● 110396			
3/4	16		● 110258	● 110391			
7/8	14		● 110266	● 110399			
1	12		● 128646	● 110386			
1 1/8	12	* 110103	● 110249	● 110381			
1 1/4	12		● 110248	● 110380	* 110505		
1 3/8	12	* 110104	● 110250		* 110507		
1 1/2	12		● 110247	● 110379			
$\varnothing'' d_1$ UNEF	P TPI	ID	ID	ID			
12	32		● 110238				
1/4	32		● 110236	● 110368	● 110493		
5/16	32		● 110241	● 110373	● 110498		
3/8	32		● 110240	● 110372	● 110497		
7/16	28		● 110243	● 110375	● 110500		
1/2	28		● 110235	● 110367	● 110492		
9/16	24		● 110245	● 110377	● 110502		
5/8	24		● 110242	● 110374	● 110499		
3/4	20		● 110239	● 110371	● 110496		
7/8	20		● 110244				
1	20		● 110253	● 110369	● 110494		

**G** DIN EN ISO 228 (BSP)  
DIN EN ISO 228-2

**PG** DIN 40430  
DIN 40431



		D5701-1	D5701-2	D5703	D5704	D5714	D5725
							
							
$\emptyset'' d_1$ G	P TPI	ID	ID	ID	ID	ID	ID
1/8	28	* 110044		● 110009	● 110277	● 110408	
1/4	19			● 110003	● 110276	● 110407	
3/8	19	* 110052		● 110162	● 110284	● 110415	
1/2	14			● 110001	● 110275	● 110406	
5/8	14			● 110164	● 110286	● 110417	
3/4	14			● 110161	● 110283	● 110414	
7/8	14	* 110054		● 110165			
1	11			● 110156	● 110278	● 110409	
1 1/8	11			● 110154		* 110404	
1 1/4	11	● 110041	● 119459		● 110272		
1 1/2	11	● 110040	● 119429		● 110271		
1 3/4	11	● 110043	● 142868		● 110274	* 110405	
2	11	● 110050	● 110126		● 110282		
2 1/4	11					* 110411	
2 1/2	11		* 110125				
2 3/4	11					* 110412	
$\emptyset d_1$ PG	P TPI	ID				ID	ID
7	20						● 110216
9	18						● 110217
11	18						● 110205
13.5	18						● 110209
16	18						● 110210
21	16					* 110331	● 110211
29	16						● 110212

# NPT

ASME B1.20.1  
ASME B1.20.1

# NPTF

ANSI B1.20.3  
ASA B2.2





		D5720	D5721				
							
							
Ø" d <sub>1</sub> NPT	P TPI	ID	ID				
1/16	27	● 110190	● 110313				
1/8	27	● 110193	● 110316				
1/4	18	● 110192	● 110315				
3/8	18	● 110197	● 110320				
1/2	14	● 110191	● 110314				
3/4	14	● 110196	● 110319				
1	11.5	● 110194	● 110317				
1 1/4	11.5	● 110189	● 110312				
1 1/2	11.5	● 110188	● 110311				
2	11.5	● 110195	● 110318				
Ø" d <sub>1</sub> NPTF	P TPI	ID	ID				
1/8	27	● 110201					
1/4	18	● 110200	* 110323				
3/8	18	● 110204					
1/2	14	● 110199	* 110322				
3/4	14	● 110203	* 110326				
1	11.5	● 110202	* 110325				

# EG M

ISO DIN 8140-2  
DIN ISO 1502

# EG UNC, EG UNF

ASME B18.29.1  
~ ISO 1502

		D5703	D5703	D5703				
								
								
Ø d, EG M	P mm	ID						
2.5	0.45	● 110132						
3	0.5	● 110133						
4	0.7	● 110134						
5	0.8	● 110135						
6	1	● 110136						
8	1.25	● 110137						
10	1.5	● 110128						
12	1.75	● 110129						
16	2	● 110131						
Ø" d, EG UNC	P TPI	ID						
4	40	● 170252						
6	32	● 170253						
8	32	● 170254						
10	24	● 170255						
1/4	20	● 170256						
5/16	18	● 170257						
3/8	16	● 170258						
Ø" d, EG UNF	P TPI	ID						
6	40	● 170259						
8	36	● 170260						
10	32	● 161020						
1/4	28	● 151790						
5/16	24	● 170261						
3/8	24	● 160134						

















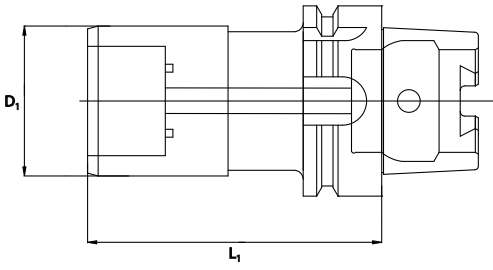















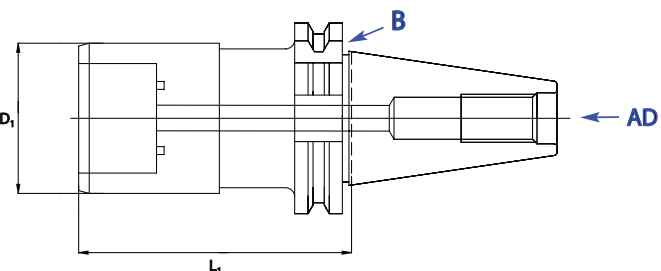

SRT 312  SYNCHRO



# SRT Synchron-Gewindeschneidfutter mit Axial-Stossdämpfer

## Tapping chucks with axial shock absorber

 Uniquement pour taraudage synchrone  
 Nur für Synchronbearbeitung  
 Only for rigid tapping  
 Solo per mescolature sincrone  
 Solo para roscado sincronizado  
 Только для rigid tapping

DIN 69 893 A	SRT-HSK63-312	SRT-HSK63-820	SRT-HSK63-1433																				
<h1>HSK</h1>																							
																							
																							
<table border="1"> <thead> <tr> <th></th> <th>D<sub>1</sub> mm</th> <th>L<sub>1</sub> mm</th> <th></th> <th></th> </tr> </thead> <tbody> <tr> <td>M3 - M12</td> <td>36</td> <td>72</td> <td>HSK A 63</td> <td>S1</td> </tr> <tr> <td>M8 - M20</td> <td>53</td> <td>89</td> <td>HSK A 63</td> <td>S2</td> </tr> <tr> <td>M14 - M33</td> <td>78</td> <td>121</td> <td>HSK A 63</td> <td>S3</td> </tr> </tbody> </table>		D <sub>1</sub> mm	L <sub>1</sub> mm			M3 - M12	36	72	HSK A 63	S1	M8 - M20	53	89	HSK A 63	S2	M14 - M33	78	121	HSK A 63	S3	<b>ID</b>	<b>ID</b>	<b>ID</b>
	D <sub>1</sub> mm	L <sub>1</sub> mm																					
M3 - M12	36	72	HSK A 63	S1																			
M8 - M20	53	89	HSK A 63	S2																			
M14 - M33	78	121	HSK A 63	S3																			
	● 170111	● 170112	● 170114																				
<b>MAS/BT Form AD + B</b>	<b>SRT-BT40-312</b>	<b>SRT-BT40-820</b>	<b>SRT-BT40-1433</b>																				
<h1>BT</h1>																							
																							
																							
<table border="1"> <thead> <tr> <th></th> <th>D<sub>1</sub> mm</th> <th>L<sub>1</sub> mm</th> <th></th> <th></th> </tr> </thead> <tbody> <tr> <td>M3 - M12</td> <td>36</td> <td>71</td> <td>BT40</td> <td>S1</td> </tr> <tr> <td>M8 - M20</td> <td>53</td> <td>85</td> <td>BT40</td> <td>S2</td> </tr> <tr> <td>M14 - M33</td> <td>78</td> <td>121</td> <td>BT40</td> <td>S3</td> </tr> </tbody> </table>		D <sub>1</sub> mm	L <sub>1</sub> mm			M3 - M12	36	71	BT40	S1	M8 - M20	53	85	BT40	S2	M14 - M33	78	121	BT40	S3	<b>ID</b>	<b>ID</b>	<b>ID</b>
	D <sub>1</sub> mm	L <sub>1</sub> mm																					
M3 - M12	36	71	BT40	S1																			
M8 - M20	53	85	BT40	S2																			
M14 - M33	78	121	BT40	S3																			
	● 170133	● 170134	● 170135																				

# SRT Synchron-Gewindeschneidfutter mit Axial-Stossdämpfer

## Tapping chucks with axial shock absorber



**SYNCHRO** Uniquement pour taraudage synchrone  
 Nur für Synchronbearbeitung  
 Only for rigid tapping  
 Solo per mescolatura sincrona  
 Solo para rosado sincronizado  
 Только для rigid tapping

DIN 69 871 Form AD + B					SRT-SK40-312	SRT-SK40-820	SRT-SK40-1433
<h1>SK</h1>							
							
							
	$D_1$ mm	$L_1$ mm		 310	<b>ID</b>	<b>ID</b>	<b>ID</b>
M3 - M12	36	65	SK40	S1	● 170124		
M8 - M20	53	79	SK40	S2		● 170125	
M14 - M33	78	115	SK40	S3			● 170126
DIN 69 871 Form AD + B					SRT-SK50-820	SRT-SK50-1433	SRT-SK50-2248
<h1>SK</h1>							
							
							
	$D_1$ mm	$L_1$ mm		 310	<b>ID</b>	<b>ID</b>	<b>ID</b>
M8 - M20	53	79	SK50	S2	● 170128		
M14 - M33	78	115	SK50	S3		● 170129	
M22 - M48	96	170	SK50	S4			● 170130

# SRT Synchron-Gewindeschneidfutter mit Axial-Stossdämpfer

## Tapping chucks with axial shock absorber

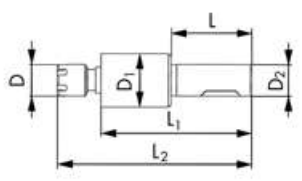
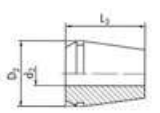
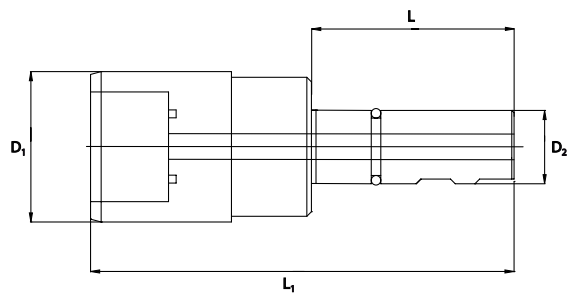









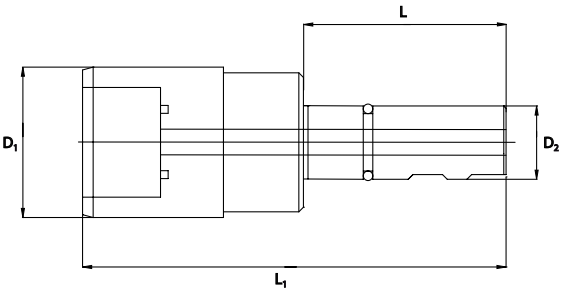













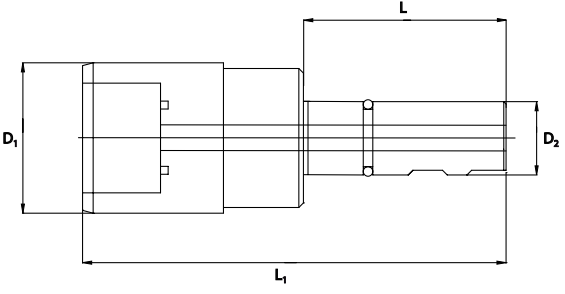

 Uniquement pour taraudage synchrone  
Nur für Synchronbearbeitung  
Only for rigid tapping  
Solo per maschietture sincrone  
Solo para roscado sincronizado  
Только для rigid tapping

DIN 1835 B	SRT032-D6		SRT054-D12		ER8	
<h1>SRT nano</h1>						
SRT032 / SRT054			D9865-			
						
	D mm	D <sub>1</sub> mm	D <sub>2</sub> mm	L mm	L <sub>1</sub> mm	L <sub>2</sub> mm
M0.3 - M2	12	11	6	25	40	56
M0.5 - M4	12	20	12	33	59	75
No	D <sub>2</sub> mm	L <sub>3</sub> mm	d <sub>2</sub> mm	ID		
ER8-0100	8.5	13.5	1	● 179401		
ER8-0150	8.5	13.5	1.5	● 179400		
ER8-0200	8.5	13.5	2	● 118895		
ER8-0250	8.5	13.5	2.5	● 118896		
ER8-0300	8.5	13.5	3	● 118897		
ER8-0350	8.5	13.5	3.5	● 118898		
ER8-0400	8.5	13.5	4	● 118899		
ER8-0450	8.5	13.5	4.5	● 118900		
DIN 1835 B	SRT312-D20		SRT312-D25		SRT520-D25	
<h1>SRT short</h1>						
						
	D <sub>1</sub> mm	D <sub>2</sub> mm	L mm	L <sub>1</sub> mm		
M3 - M12	39	20	47	86	S1	
M3 - M12	39	25	53	90	S1	
M5 - M20	56	25	53	110	S2	
					310	
					ID	
					● 162832	
					● 162831	
					● 162833	

# SRT Synchron-Gewindeschneidfutter mit Axial-Stossdämpfer



## Tapping chucks with axial shock absorber

 Uniquement pour taraudage synchrone  
 Nur für Synchronbearbeitung  
 Only for rigid tapping  
 Solo per mescolatura sincrona  
 Solo para roscado sincronizado  
 Только для rigid tapping

DIN 1835 B	SRT-1D20-312	SRT-1D25-312	SRT-2D25-820																												
<h1>SRT</h1>																															
	 	 	 																												
<table border="1"> <thead> <tr> <th></th> <th>D<sub>1</sub> mm</th> <th>D<sub>2</sub> mm</th> <th>L mm</th> <th>L<sub>1</sub> mm</th> <th></th> <th> 310</th> </tr> </thead> <tbody> <tr> <td>M3 - M12</td> <td>36</td> <td>20</td> <td>51</td> <td>97</td> <td>S1</td> <td></td> </tr> <tr> <td>M3 - M12</td> <td>36</td> <td>25</td> <td>57</td> <td>103</td> <td>S1</td> <td></td> </tr> <tr> <td>M8 - M20</td> <td>53</td> <td>25</td> <td>57</td> <td>131</td> <td>S2</td> <td></td> </tr> </tbody> </table>		D <sub>1</sub> mm	D <sub>2</sub> mm	L mm	L <sub>1</sub> mm		 310	M3 - M12	36	20	51	97	S1		M3 - M12	36	25	57	103	S1		M8 - M20	53	25	57	131	S2		<b>ID</b>	<b>ID</b>	<b>ID</b>
	D <sub>1</sub> mm	D <sub>2</sub> mm	L mm	L <sub>1</sub> mm		 310																									
M3 - M12	36	20	51	97	S1																										
M3 - M12	36	25	57	103	S1																										
M8 - M20	53	25	57	131	S2																										
	● 170140																														
		● 170020																													
			● 170141																												
DIN 1835 B	SRT-2D32-820	SRT-3D25-1433	SRT-3D32-1433																												
<h1>SRT</h1>																															
	 	 	 																												
<table border="1"> <thead> <tr> <th></th> <th>D<sub>1</sub> mm</th> <th>D<sub>2</sub> mm</th> <th>L mm</th> <th>L<sub>1</sub> mm</th> <th></th> <th> 310</th> </tr> </thead> <tbody> <tr> <td>M8 - M20</td> <td>53</td> <td>32</td> <td>61.5</td> <td>135.5</td> <td>S2</td> <td></td> </tr> <tr> <td>M14 - M33</td> <td>78</td> <td>25</td> <td>57</td> <td>164.5</td> <td>S3</td> <td></td> </tr> <tr> <td>M14 - M33</td> <td>78</td> <td>32</td> <td>61.5</td> <td>169</td> <td>S3</td> <td></td> </tr> </tbody> </table>		D <sub>1</sub> mm	D <sub>2</sub> mm	L mm	L <sub>1</sub> mm		 310	M8 - M20	53	32	61.5	135.5	S2		M14 - M33	78	25	57	164.5	S3		M14 - M33	78	32	61.5	169	S3		<b>ID</b>	<b>ID</b>	<b>ID</b>
	D <sub>1</sub> mm	D <sub>2</sub> mm	L mm	L <sub>1</sub> mm		 310																									
M8 - M20	53	32	61.5	135.5	S2																										
M14 - M33	78	25	57	164.5	S3																										
M14 - M33	78	32	61.5	169	S3																										
	● 170142																														
		● 170143																													
			● 170144																												

# SRT *Einsätze ohne Sicherheitskupplung* Inserts without slipping clutch

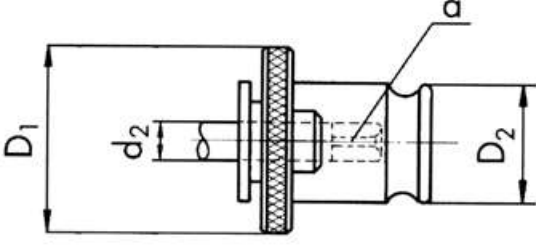
 Uniquement pour taraudage synchrone  
Nur für Synchronbearbeitung  
Only for rigid tapping  
Solo per mescolature sincrone  
Solo para roscado sincronizado  
Только для rigid tapping

<h1>SRT</h1>					S1-	S2-	S3-	S4-
								
No	D <sub>1</sub> mm	D <sub>2</sub> mm	d <sub>2</sub> mm	α mm	ID	ID	ID	ID
S1-0028	30	19	2.8	2.1	● 129915			
S1-0035	30	19	3.5	2.7	● 129916			
S1-0045	30	19	4.5	3.4	● 129918			
S1-0060	30	19	6	4.9	● 129920			
S1-0070	30	19	7	5.5	● 129921			
S1-0080	30	19	8	6.2	● 129922			
S1-0090	30	19	9	7	● 129923			
S1-0100	30	19	10	8	● 129924			
S1-0110	30	19	11	9	● 129925			
S2-0060	48	31	6	4.9		● 129927		
S2-0070	48	31	7	5.5		● 129928		
S2-0080	48	31	8	6.2		● 129929		
S2-0090	48	31	9	7		● 129930		
S2-0100	48	31	10	8		● 129931		
S2-0110	48	31	11	9		● 148303		
S2-0120	48	31	12	9		● 129932		
S2-0140	48	31	14	11		● 129933		
S2-0160	48	31	16	12		● 129934		
S2-0180	48	31	18	14.5		● 151355		
S3-0110	70	48	11	9			● 170145	
S3-0120	70	48	12	9			● 170146	
S3-0140	70	48	14	11			● 170147	
S3-0160	70	48	16	12			● 170148	
S3-0180	70	48	18	14.5			● 170149	
S3-0200	70	48	20	16			● 170150	
S3-0220	70	48	22	18			● 170151	
S3-0250	70	48	25	20			● 170152	
S4-0180	96	60	18	14.5				● 170153
S4-0200	96	60	20	16				● 170154
S4-0220	96	60	22	18				● 170155
S4-0250	96	60	25	20				● 170156
S4-0280	96	60	28	22				● 170157
S4-0320	96	60	32	24				● 170158
S4-0360	96	60	36	29				● 170159



**Einsätze mit Sicherheitskupplung**  
**Inserts with slipping clutch**



# CLASSIC

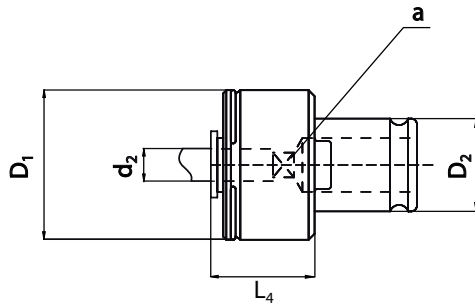

SC1-

SC2-

SC3-

SC4-



No	$D_1$ mm	$D_2$ mm	$d_2$ mm	$a$ mm	$L_4$ mm	ID	ID	ID	ID
SC1-0028	32	19	2.8	2.1	25	● 170160			
SC1-0035	32	19	3.5	2.7	25	● 170161			
SC1-0045	32	19	4.5	3.4	25	● 170162			
SC1-0060	32	19	6	4.9	25	● 170163			
SC1-0070	32	19	7	5.5	25	● 170164			
SC1-0080	32	19	8	6.2	25	● 170165			
SC1-0090	32	19	9	7	25	● 170166			
SC1-0100	32	19	10	8	25	● 170167			
SC2-0060	50	31	6	4.9	34		● 170168		
SC2-0070	50	31	7	5.5	34		● 170169		
SC2-0080	50	31	8	6.2	34		● 170170		
SC2-0090	50	31	9	7	34		● 170171		
SC2-0100	50	31	10	8	34		● 170172		
SC2-0110	50	31	11	9	34		● 170173		
SC2-0120	50	31	12	9	34		● 170174		
SC2-0140	50	31	14	11	34		● 170175		
SC2-0160	50	31	16	12	34		● 170176		
SC2-0180	50	31	18	14.5	34		● 170177		
SC3-0110	72	48	11	9	45			● 170178	
SC3-0120	72	48	12	9	45			● 170179	
SC3-0140	72	48	14	11	45			● 170180	
SC3-0160	72	48	16	12	45			● 170181	
SC3-0180	72	48	18	14.5	45			● 170182	
SC3-0200	72	48	20	16	45			● 170183	
SC3-0220	72	48	22	18	45			● 170184	
SC3-0250	72	48	25	20	45			● 170185	
SC4-0180	96	60	18	14.5	68				● 170186
SC4-0200	96	60	20	16	68				● 170187
SC4-0220	96	60	22	18	68				● 170188
SC4-0250	96	60	25	20	68				● 170189
SC4-0280	96	60	28	22	68				● 170190
SC4-0320	96	60	32	24	68				● 170191
SC4-0360	96	60	36	29	68				● 170192

# ANWENDUNGSTABELLE — APPLICATION CHART

## Programmierzklus für Zentrierbohrer C315VS

## Programming cycle for spotting drills C315VS

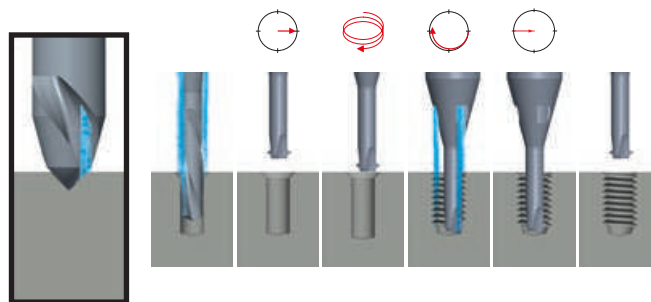

### DC -Anwendungsgruppen

### DC Material classification

Werkstoff-Gruppen Material groups	Werkstoffbezeichnung	Material designation	Härte Hardness (HB)	Festigkeit Tensile strength Rm (N/mm <sup>2</sup> )	Kühlung Lubricant  Beschichtet Coated
<b>10</b> Stahl Steels	11 Automatenstahl	Free-cutting steels	< 200	< 700	
	12 Baustahl, Einsatzstahl	Structural, cementation steels	< 200	< 700	
	13 Kohlenstoffstahl	Carbon steels	< 300	< 1000	
	14 Stahl legiert < 850 N/mm <sup>2</sup>	Alloy steels < 850 N/mm <sup>2</sup>	< 250	< 850	
	15 Stahl legiert / vergütet > 850 - < 1150 N/mm <sup>2</sup>	Alloy steels hard. / temp. > 850 - < 1150 N/mm <sup>2</sup>	> 250	> 850	
	16 Hochfester Stahl ≤ 44 HRC	High tensile alloy steels ≤ 44 HRC	> 250	> 850	
	17 Stahl vergütet > 44 - ≤ 54 HRC	Alloy steels tempered > 44 - ≤ 54 HRC	> 410	> 1400	
	18 Stahl gehärtet > 54 - ≤ 63 HRC	Alloy steels hardened > 54 - ≤ 63 HRC	> 560	> 1980	
<b>20</b> Rostfreier Stahl Stainless steels	21 Rostfreier Stahl, geschwefelt	Free machining stainless steels	< 250	< 850	
	22 Austenitisch	Austenitic stainless steels	< 250	< 850	
	23 Ferritisch, martensitisch < 850 N/mm <sup>2</sup>	Ferritic and martensitic < 850 N/mm <sup>2</sup>	< 250	< 850	
	24 Ferritisch, martensitisch > 850 - < 1150 N/mm <sup>2</sup>	Ferritic and martensitic > 850 - < 1150 N/mm <sup>2</sup>	> 250	> 850	
<b>30</b> Guss Cast iron	31 Grauguss	Cast iron	< 250	< 850	
	32 Kugelgraphitguss, Temperguss	Spheroidal graphite + malleable cast iron	< 250	< 850	
<b>40</b> Titan Titanium	41 Reintitan	Pure titanium	< 250	< 850	
	42 Titanlegierung	Titanium alloys	> 250	> 850	
<b>50</b> Nickel Nickel	51 Nickellegierung 1 ≤ 850 N/mm <sup>2</sup>	Nickel alloys 1 ≤ 850 N/mm <sup>2</sup>	< 250	< 850	
	52 Nickellegierung 2 > 850 - ≤ 1150 N/mm <sup>2</sup>	Nickel alloys 2 > 850 - ≤ 1150 N/mm <sup>2</sup>	> 250	> 850	
	53 Nickellegierung 3 > 1150 - ≤ 1600 N/mm <sup>2</sup>	Nickel alloys 3 > 1150 - ≤ 1600 N/mm <sup>2</sup>	> 340	> 1150	
<b>60</b> Kupfer Copper	61 Reinkupfer (Elektrolytkupfer)	Pure copper (electrolytic copper)	< 120	< 400	
	62 Messing, Bronze, Rotguss (kurzspanend)	Short chip brass, phosphor bronze, gun metal	< 200	< 700	
	63 Messing (langspanend)	Long chip brass	< 200	< 700	
	64 Messing bleifrei	Lead free brass	< 220	< 700	
<b>70</b> Aluminium Magnesium Aluminium Magnesium	71 Al unlegiert	Al unalloyed	< 100	< 350	
	72 Al legiert Si < 1.5 %	Al alloyed Si < 1.5 %	< 150	< 500	
	73 Al legiert Si > 1.5 % - < 10 %	Al alloyed Si > 1.5 % - < 10 %	< 120	< 400	
	74 Al legiert Si > 10 %, Mg-Legierungen	Al alloyed Si > 10 %, Mg-alloys	< 120	< 400	
<b>80</b> Kunststoff Plastic compounds	81 Thermoplaste	Thermoplastics	-	-	
	82 Duroplaste	Duroplastics	-	-	
	83 Faserverstärkte Kunststoffe	Glass fibre reinforced plastics	-	-	
<b>90</b> Edelmetalle Precious metals	91 Gelbgold	Yellow gold	-	-	
	92 Rotgold	Red gold	-	-	
	93 Weissgold	White gold	-	-	
	94 Silber	Silver	-	-	



# ZENTRIERBOHRER C315VS — SPOTTING DRILLS C315VS

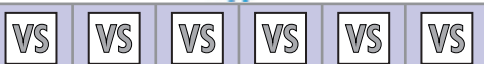

	Vc (m/min) Guide Line Beschichtet Coated	Vorschub f (mm/U)						Feed rate f (mm/rev.)					
		Ø 1.40		Ø 2.00		Ø 3.00		Ø 4.00		Ø 6.00		Ø 8.00	
11	120	0.05	0.08	0.10	0.12	0.15	0.20	11					
12	120	0.05	0.08	0.10	0.12	0.15	0.20	12					
13	120	0.05	0.08	0.10	0.12	0.15	0.20	13					
14	80	0.05	0.08	0.10	0.12	0.15	0.20	14					
15	60	0.03	0.04	0.06	0.08	0.12	0.18	15					
16	40	0.02	0.03	0.04	0.05	0.06	0.07	16					
17	40	0.02	0.03	0.04	0.05	0.06	0.07	17					
18								18					
21	60	0.03	0.04	0.06	0.08	0.12	0.18	21					
22	50	0.03	0.04	0.06	0.07	0.09	0.11	22					
23	50	0.03	0.04	0.06	0.07	0.09	0.11	23					
24	50	0.03	0.04	0.06	0.07	0.09	0.11	24					
31	100	0.04	0.05	0.07	0.09	0.11	0.15	31					
32	100	0.04	0.05	0.07	0.09	0.11	0.15	32					
41	25	0.03	0.04	0.06	0.07	0.09	0.11	41					
42	25	0.04	0.07	0.09	0.11	0.14	0.18	42					
51	25	0.025	0.03	0.04	0.05	0.07	0.09	51					
52	20	0.025	0.03	0.04	0.05	0.07	0.09	52					
53	10	0.025	0.03	0.04	0.05	0.07	0.09	53					
61	100	0.06	0.09	0.11	0.13	0.18	0.23	61					
62	100	0.06	0.09	0.11	0.13	0.16	0.18	62					
63	80	0.06	0.09	0.11	0.13	0.16	0.18	63					
64	80	0.06	0.09	0.11	0.13	0.16	0.18	64					
71	150	0.06	0.09	0.11	0.13	0.18	0.23	71					
72	150	0.06	0.09	0.11	0.13	0.18	0.23	72					
73	100	0.06	0.09	0.11	0.13	0.18	0.23	73					
74	100	0.06	0.09	0.11	0.13	0.18	0.23	74					
81	200	0.08	0.11	0.13	0.15	0.20	0.25	81					
82	200	0.08	0.11	0.13	0.15	0.20	0.25	82					
83	100	0.08	0.11	0.13	0.15	0.20	0.25	83					
91	200	0.08	0.11	0.13	0.15	0.20	0.25	91					
92	150	0.08	0.11	0.13	0.15	0.20	0.25	92					
93	100	0.08	0.11	0.13	0.15	0.20	0.25	93					
94	100	0.08	0.11	0.13	0.15	0.20	0.25	94					

Bei den oben aufgeführten Daten handelt es sich um Richtwerte.  
The indicated values are a guideline.

# ANWENDUNGSTABELLE — APPLICATION CHART

## Programmierzklus für Spiralbohrer FZ315VS

## Programming cycle for twist drills FZ315VS

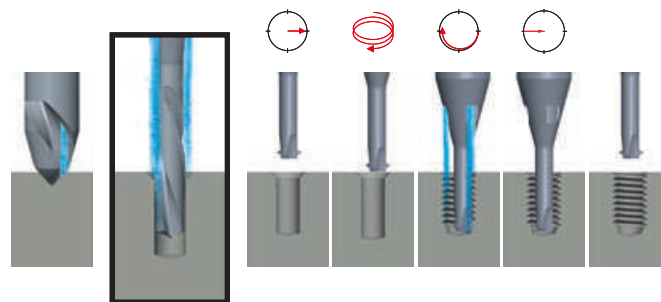

### DC -Anwendungsgruppen

### DC Material classification

Werkstoff-Gruppen Material groups	Werkstoffbezeichnung	Material designation	Härte Hardness (HB)	Festigkeit Tensile strength Rm (N/mm <sup>2</sup> )	Kühlung Lubricant  Beschichtet Coated
<b>10</b> Stahl Steels	11 Automatenstahl	Free-cutting steels	< 200	< 700	
	12 Baustahl, Einsatzstahl	Structural, cementation steels	< 200	< 700	
	13 Kohlenstoffstahl	Carbon steels	< 300	< 1000	
	14 Stahl legiert < 850 N/mm <sup>2</sup>	Alloy steels < 850 N/mm <sup>2</sup>	< 250	< 850	
	15 Stahl legiert / vergütet > 850 - < 1150 N/mm <sup>2</sup>	Alloy steels hard. / temp. > 850 - < 1150 N/mm <sup>2</sup>	> 250	> 850	
	16 Hochfester Stahl ≤ 44 HRC	High tensile alloy steels ≤ 44 HRC	> 250	> 850	
	17 Stahl vergütet > 44 - ≤ 54 HRC	Alloy steels tempered > 44 - ≤ 54 HRC	> 410	> 1400	
	18 Stahl gehärtet > 54 - ≤ 63 HRC	Alloy steels hardened > 54 - ≤ 63 HRC	> 560	> 1980	
<b>20</b> Rostfreier Stahl Stainless steels	21 Rostfreier Stahl, geschwefelt	Free machining stainless steels	< 250	< 850	
	22 Austenitisch	Austenitic stainless steels	< 250	< 850	
	23 Ferritisch, martensitisch < 850 N/mm <sup>2</sup>	Ferritic and martensitic < 850 N/mm <sup>2</sup>	< 250	< 850	
	24 Ferritisch, martensitisch > 850 - < 1150 N/mm <sup>2</sup>	Ferritic and martensitic > 850 - < 1150 N/mm <sup>2</sup>	> 250	> 850	
<b>30</b> Guss Cast iron	31 Grauguss	Cast iron	< 250	< 850	
	32 Kugelgraphitguss, Temperguss	Spheroidal graphite + malleable cast iron	< 250	< 850	
<b>40</b> Titan Titanium	41 Reintitan	Pure titanium	< 250	< 850	
	42 Titanlegierung	Titanium alloys	> 250	> 850	
<b>50</b> Nickel Nickel	51 Nickellegierung 1 ≤ 850 N/mm <sup>2</sup>	Nickel alloys 1 ≤ 850 N/mm <sup>2</sup>	< 250	< 850	
	52 Nickellegierung 2 > 850 - ≤ 1150 N/mm <sup>2</sup>	Nickel alloys 2 > 850 - ≤ 1150 N/mm <sup>2</sup>	> 250	> 850	
	53 Nickellegierung 3 > 1150 - ≤ 1600 N/mm <sup>2</sup>	Nickel alloys 3 > 1150 - ≤ 1600 N/mm <sup>2</sup>	> 340	> 1150	
<b>60</b> Kupfer Copper	61 Reinkupfer (Elektrolytkupfer)	Pure copper (electrolytic copper)	< 120	< 400	
	62 Messing, Bronze, Rotguss (kurzspanend)	Short chip brass, phosphor bronze, gun metal	< 200	< 700	
	63 Messing (langspanend)	Long chip brass	< 200	< 700	
	64 Messing bleifrei	Lead free brass	< 220	< 700	
<b>70</b> Aluminium Magnesium Aluminium Magnesium	71 Al unlegiert	Al unalloyed	< 100	< 350	
	72 Al legiert Si < 1.5 %	Al alloyed Si < 1.5 %	< 150	< 500	
	73 Al legiert Si > 1.5 % - < 10 %	Al alloyed Si > 1.5 % - < 10 %	< 120	< 400	
	74 Al legiert Si > 10 %, Mg-Legierungen	Al alloyed Si > 10 %, Mg-alloys	< 120	< 400	
<b>80</b> Kunststoff Plastic compounds	81 Thermoplaste	Thermoplastics	-	-	
	82 Duroplaste	Duroplastics	-	-	
	83 Faserverstärkte Kunststoffe	Glass fibre reinforced plastics	-	-	
<b>90</b> Edelmetalle Precious metals	91 Gelbgold	Yellow gold	-	-	
	92 Rotgold	Red gold	-	-	
	93 Weissgold	White gold	-	-	
	94 Silber	Silver	-	-	

# SPIRALBOHRER FZ315VS — TWIST DRILLS FZ315VS

		FZ315VS						FZ315VS					
		VS				VS		VS				VS	
		Vorschub f (mm/U)				Feed rate f (mm/rev.)		Vorschub f (mm/U)				Feed rate f (mm/rev.)	
		Ø0.58-0.82	Ø0.83-1.07	Ø1.08-1.46	Ø1.47-2.0	Q1	Qx	Ø2.01-3.05	Ø3.06-4.5	Ø4.51-5.4	Qx		
		Beschichtet Coated						Beschichtet Coated					
Vc (m/min) Guide Line Ø 0.58 - 2.0								Vc (m/min) Guide Line Ø 2.01 - 5.4					
11	40 - 60	0.02-0.035	0.03-0.045	0.04-0.055	0.05-0.065	1xd,-4xd	1xd,-2xd	80 - 110	0.07-0.12	0.12-0.18	0.18-0.23		11
12	40 - 60	0.02-0.035	0.03-0.045	0.04-0.055	0.05-0.065	1xd,-4xd	1xd,-2xd	80 - 110	0.07-0.12	0.12-0.17	0.17-0.22		12
13	35 - 55	0.015-0.025	0.025-0.035	0.035-0.045	0.045-0.055	1xd,-4xd	1xd,-2xd	70 - 100	0.07-0.12	0.12-0.17	0.17-0.22		13
14	35 - 55	0.015-0.025	0.025-0.035	0.035-0.045	0.045-0.055	1xd,-4xd	1xd,-2xd	70 - 100	0.07-0.12	0.12-0.17	0.17-0.22		14
15	35 - 55	0.015-0.025	0.025-0.035	0.035-0.045	0.045-0.055	1xd,-4xd	1xd,-2xd	70 - 100	0.07-0.12	0.12-0.17	0.17-0.22		15
16	35 - 55	0.015-0.025	0.025-0.035	0.035-0.045	0.045-0.055	1xd,-4xd	1xd,-2xd	70 - 100	0.07-0.10	0.10-0.14	0.14-0.17		16
17	30 - 45	0.015-0.025	0.025-0.035	0.035-0.045	0.045-0.055	1xd,-4xd	1xd,-2xd	60 - 80	0.07-0.10	0.10-0.15	0.14-0.18		17
18													18
21	30 - 45	0.015-0.025	0.025-0.035	0.035-0.045	0.045-0.055	1xd,-4xd	1xd,-2xd	60 - 80	0.045-0.055	0.055-0.07	0.07-0.10		21
22	30 - 45	0.015-0.025	0.025-0.035	0.035-0.045	0.045-0.055	1xd,-4xd	1xd,-2xd	60 - 80	0.045-0.055	0.055-0.07	0.07-0.10		22
23	35 - 50	0.02-0.025	0.025-0.035	0.04-0.05	0.05-0.065	1xd,-4xd	1xd,-2xd	60 - 80	0.05-0.065	0.05-0.065	0.06-0.09		23
24	35 - 50	0.02-0.025	0.025-0.035	0.04-0.05	0.05-0.065	1xd,-4xd	1xd,-2xd	60 - 80	0.05-0.065	0.05-0.065	0.06-0.09		24
31	50 - 80	0.025-0.045	0.045-0.065	0.065-0.085	0.085-0.10	4xd,-8xd	4xd	90 - 130	0.10-0.15	0.15-0.20	0.20-0.25		31
32	40 - 70	0.025-0.045	0.045-0.065	0.065-0.085	0.085-0.10	4xd,-8xd	4xd	80 - 120	0.10-0.14	0.14-0.18	0.18-0.23		32
41	15 - 25	0.005-0.02	0.015-0.045	0.04-0.06	0.055-0.07	1/2xd,-1xd	1/4xd,-1/2xd	30 - 40	0.055-0.07	0.055-0.07	0.055-0.07	1/3xd,-1/2xd	41
42	15 - 25	0.005-0.02	0.015-0.045	0.04-0.06	0.055-0.07	1/2xd,-1xd	1/4xd,-1/2xd	30 - 40	0.055-0.07	0.055-0.07	0.055-0.07	1/3xd,-1/2xd	42
51	15 - 25	0.005-0.02	0.02-0.025	0.025-0.035	0.035-0.05	1/2xd,-1xd	1/2xd	30 - 40	0.035-0.05	0.035-0.05	0.05-0.08		51
52	15 - 25	0.015-0.02	0.02-0.025	0.025-0.035	0.035-0.05	1/2xd,-1xd	1/2xd	30 - 40	0.035-0.05	0.035-0.05	0.05-0.08		52
53	15 - 25	0.005-0.01	0.01-0.02	0.02-0.03	0.03-0.04	1/2xd,-1xd	1/2xd	30 - 40	0.03-0.04	0.03-0.04	0.04-0.06		53
61	50 - 80	0.05-0.08	0.06-0.10	0.08-0.12	0.12-0.15	4xd,-8xd	4xd	130 - 180	0.12-0.15	0.15-0.20	0.20-0.25		61
62	50 - 80	0.05-0.08	0.06-0.10	0.08-0.12	0.12-0.15	4xd,-8xd	4xd	130 - 180	0.12-0.15	0.15-0.20	0.20-0.25		62
63	50 - 80	0.05-0.08	0.06-0.10	0.08-0.12	0.12-0.15	4xd,-8xd	4xd	80 - 110	0.12-0.15	0.14-0.18	0.18-0.23		63
64	50 - 80	0.05-0.08	0.06-0.1	0.08-0.12	0.12-0.15	4xd,-8xd	4xd	80 - 110	0.12-0.15	0.14-0.18	0.18-0.23		64
71	50 - 80	0.05-0.08	0.06-0.10	0.08-0.12	0.12-0.15	2xd,-3xd	3xd	130 - 180	0.12-0.15	0.15-0.20	0.20-0.25		71
72	50 - 80	0.05-0.08	0.06-0.10	0.08-0.12	0.12-0.15	2xd,-3xd	3xd	130 - 180	0.12-0.15	0.15-0.20	0.20-0.25		72
73	50 - 80	0.05-0.08	0.06-0.10	0.08-0.12	0.12-0.15	2xd,-3xd	3xd	100 - 130	0.12-0.15	0.14-0.18	0.18-0.23		73
74	50 - 80	0.05-0.08	0.06-0.10	0.08-0.12	0.12-0.15	2xd,-3xd	3xd	100 - 130	0.12-0.15	0.14-0.18	0.18-0.23		74
81	50 - 80	0.05-0.08	0.06-0.10	0.08-0.12	0.12-0.15	4xd,-8xd	4xd	130 - 180	0.12-0.15	0.15-0.20	0.20-0.25		81
82	50 - 80	0.05-0.08	0.06-0.10	0.08-0.12	0.12-0.15	4xd,-8xd	4xd	130 - 180	0.12-0.15	0.15-0.20	0.20-0.25		82
83	40 - 60	0.02-0.035	0.03-0.045	0.04-0.055	0.05-0.065	2xd,-3xd	3xd	80 - 120	0.07-0.12	0.12-0.18	0.18-0.23		83
91	50 - 80	0.02-0.035	0.03-0.045	0.04-0.055	0.05-0.065	2xd,-3xd	3xd	130 - 180	0.07-0.12	0.12-0.17	0.17-0.22		91
92	50 - 80	0.02-0.035	0.03-0.045	0.04-0.055	0.05-0.065	2xd,-3xd	3xd	130 - 180	0.07-0.12	0.12-0.17	0.17-0.22		92
93	40 - 60	0.02-0.035	0.03-0.045	0.04-0.055	0.05-0.065	2xd,-3xd	3xd	80 - 110	0.07-0.12	0.12-0.17	0.17-0.22		93
94	40 - 60	0.02-0.035	0.03-0.045	0.04-0.055	0.05-0.065	2xd,-3xd	3xd	80 - 110	0.07-0.12	0.12-0.17	0.17-0.22		94

Bei den oben aufgeführten Daten handelt es sich um Richtwerte.  
The indicated values are a guideline.

# ANWENDUNGSTABELLE — APPLICATION CHART

## DC -Anwendungsgruppen

## DC Material classification

Werkstoff-Gruppen Material groups		Werkstoffbezeichnung	Material designation	Härte Hardness (HB)	Festigkeit Tensile strength Rm (N/mm <sup>2</sup> )	Kühlung Lubricant  Beschichtet Coated
10 Stahl Steels	11	Automatenstahl	Free-cutting steels	< 200	< 700	
	12	Baustahl, Einsatzstahl	Structural, cementation steels	< 200	< 700	
	13	Kohlenstoffstahl	Carbon steels	< 300	< 1000	
	14	Stahl legiert < 850 N/mm <sup>2</sup>	Alloy steels < 850 N/mm <sup>2</sup>	< 250	< 850	
	15	Stahl legiert / vergütet > 850 - < 1150 N/mm <sup>2</sup>	Alloy steels hard. / temp. > 850 - < 1150 N/mm <sup>2</sup>	> 250	> 850	
	16	Hochfester Stahl ≤ 44 HRC	High tensile alloy steels ≤ 44 HRC	> 250	> 850	
	17	Stahl vergütet > 44 - ≤ 54 HRC	Alloy steels tempered > 44 - ≤ 54 HRC	> 410	> 1400	
	18	Stahl gehärtet > 54 - ≤ 63 HRC	Alloy steels hardened > 54 - ≤ 63 HRC	> 560	> 1980	
20 Rostfreier Stahl Stainless steels	21	Rostfreier Stahl, geschwefelt	Free machining stainless steels	< 250	< 850	
	22	Austenitisch	Austenitic stainless steels	< 250	< 850	
	23	Ferritisch, martensitisch < 850 N/mm <sup>2</sup>	Ferritic and martensitic < 850 N/mm <sup>2</sup>	< 250	< 850	
	24	Ferritisch, martensitisch > 850 - < 1150 N/mm <sup>2</sup>	Ferritic and martensitic > 850 - < 1150 N/mm <sup>2</sup>	> 250	> 850	
30 Guss Cast iron	31	Grauguss	Cast iron	< 250	< 850	
	32	Kugelgraphitguss, Temperguss	Spheroidal graphite + malleable cast iron	< 250	< 850	
40 Titan Titanium	41	Reintitan	Pure titanium	< 250	< 850	
	42	Titanlegierung	Titanium alloys	> 250	> 850	
50 Nickel Nickel	51	Nickellegierung 1 ≤ 850 N/mm <sup>2</sup>	Nickel alloys 1 ≤ 850 N/mm <sup>2</sup>	< 250	< 850	
	52	Nickellegierung 2 > 850 - ≤ 1150 N/mm <sup>2</sup>	Nickel alloys 2 > 850 - ≤ 1150 N/mm <sup>2</sup>	> 250	> 850	
	53	Nickellegierung 3 > 1150 - ≤ 1600 N/mm <sup>2</sup>	Nickel alloys 3 > 1150 - ≤ 1600 N/mm <sup>2</sup>	> 340	> 1150	
60 Kupfer Copper	61	Reinkupfer (Elektrolytkupfer)	Pure copper (electrolytic copper)	< 120	< 400	
	62	Messing, Bronze, Rotguss (kurzspanend)	Short chip brass, phosphor bronze, gun metal	< 200	< 700	
	63	Messing (langspanend)	Long chip brass	< 200	< 700	
	64	Messing bleifrei	Lead free brass	< 220	< 700	
70 Aluminium Magnesium Aluminium Magnesium	71	Al unlegiert	Al unalloyed	< 100	< 350	
	72	Al legiert Si < 1.5 %	Al alloyed Si < 1.5 %	< 150	< 500	
	73	Al legiert Si > 1.5 % - < 10 %	Al alloyed Si > 1.5 % - < 10 %	< 120	< 400	
	74	Al legiert Si > 10 %, Mg-Legierungen	Al alloyed Si > 10 %, Mg-alloys	< 120	< 400	
80 Kunststoff Plastic compounds	81	Thermoplaste	Thermoplastics	-	-	
	82	Duroplaste	Duroplastics	-	-	
	83	Faserverstärkte Kunststoffe	Glass fibre reinforced plastics	-	-	
90 Edelmetalle Precious metals	91	Gelbgold	Yellow gold	-	-	
	92	Rotgold	Red gold	-	-	
	93	Weissgold	White gold	-	-	
	94	Silber	Silver	-	-	

# F286VS — F286VS



		F286VS							
		VS	VS	VS	VS	VS	VS		
		Vorschub f (mm/U)			Feed rate f (mm/rev.)				
		Ø 0.8 - 1.2	Ø 1.21 - 3.0	Ø 3.01 - 6.0	Ø 6.01 - 8.5	Ø 8.51 - 11.0	Ø 11.02 - 14.0		
V <sub>c</sub> (m/min) Guide Line	Beschichtet Coated								
11	70 - 90	0.015-0.025	0.015-0.025	0.035-0.045	0.11-0.13	0.15-0.17	0.18-0.22	11	
12	70 - 90	0.10-0.20	0.015-0.025	0.035-0.045	0.11-0.13	0.15-0.17	0.18-0.22	12	
13	70 - 90	0.10-0.20	0.015-0.025	0.035-0.045	0.11-0.13	0.15-0.17	0.18-0.22	13	
14	70 - 90	0.10-0.20	0.015-0.025	0.035-0.045	0.11-0.13	0.15-0.17	0.18-0.22	14	
15	60 - 80	0.10-0.20	0.015-0.025	0.035-0.045	0.07-0.09	0.11-0.13	0.15-0.17	15	
16								16	
17								17	
18								18	
21	40 - 60	0.008-0.012	0.015-0.02	0.035-0.04	0.075-0.085	0.095-0.105	0.15-0.16	21	
22	40 - 60	0.008-0.012	0.015-0.02	0.035-0.04	0.075-0.085	0.095-0.105	0.15-0.16	22	
23	40 - 60	0.008-0.012	0.015-0.02	0.035-0.04	0.075-0.085	0.095-0.105	0.15-0.16	23	
24	40 - 60	0.008-0.012	0.015-0.02	0.035-0.04	0.075-0.085	0.095-0.105	0.15-0.16	24	
31								31	
32								32	
41	40 - 80	0.003-0.006	0.008-0.012	0.01-0.018	0.025-0.03	0.055-0.06	0.075-0.085	41	
42								42	
51	30 - 50	0.008-0.012	0.015-0.02	0.035-0.04	0.075-0.085	0.095-0.105	0.11-0.13	51	
52								52	
53								53	
61	70 - 150	0.15-0.25	0.035-0.045	0.055-0.065	0.11-0.13	0.15-0.17	0.18-0.22	61	
62								62	
63	70 - 150	0.15-0.25	0.035-0.045	0.055-0.065	0.11-0.13	0.15-0.17	0.18-0.22	63	
64	70 - 150	0.15-0.25	0.035-0.045	0.055-0.065	0.11-0.13	0.15-0.17	0.18-0.22	64	
71	100 - 160	0.025-0.035	0.045-0.055	0.075-0.085	0.15-0.17	0.22-0.26	0.30-0.34	71	
72	100 - 160	0.025-0.035	0.045-0.055	0.075-0.085	0.15-0.17	0.22-0.26	0.30-0.34	72	
73	60 - 130	0.02-0.03	0.035-0.045	0.055-0.065	0.11-0.13	0.16-0.20	0.22-0.26	73	
74								74	
81								81	
82								82	
83								83	
91								91	
92								92	
93	40 - 60	0.008-0.012	0.015-0.02	0.035-0.04	0.075-0.085	0.095-0.105	0.15-0.16	93	
94	40 - 60	0.008-0.012	0.015-0.02	0.035-0.04	0.075-0.085	0.095-0.105	0.15-0.16	94	

Bei den oben aufgeführten Daten handelt es sich um Richtwerte.  
The indicated values are a guideline.

**Vollhartmetall-Zentrierbohrer**  
**Solid carbide spotting drills**

VHM  
CAR

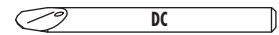

h6

C

C315VS

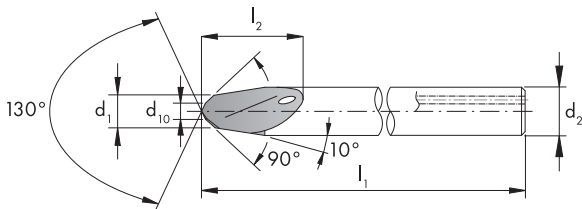
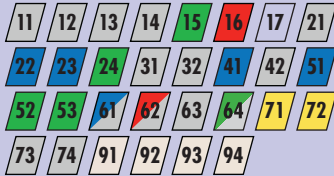
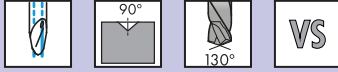

C315VS



Ø d <sub>1</sub>	l <sub>1</sub> mm	l <sub>2</sub> mm	d <sub>2</sub> h6 mm	d <sub>10</sub> mm	
1.4	40	6	3	0.5	2
2	40	6.2	3	1	2
3	40	6.3	3	1.5	2
4	50	8	4	2	2
6	60	12	6	3	2
8	70	16	8	4	2

ID

- 182872
- 182873
- 182874
- 190331
- 190332
- 190333

# Vollhartmetall-Spiralbohrer

## Solid carbide twist drills

VHM  
CAR

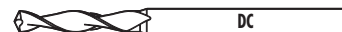

h6

# FZ

FZ315VS



VS

FZ315VS



VS

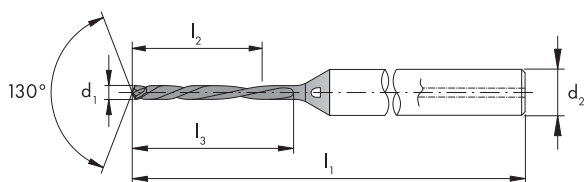

FZ315VS

FZ315VS



Ø d <sub>1</sub>	D <sub>1</sub> mm	l <sub>1</sub> mm	l <sub>2</sub> mm	l <sub>3</sub> mm	d <sub>2</sub> h6 mm	
0.58	M0.8	42	4.6	5.7	3	2
0.59	S0.8	42	4.7	5.8	3	2
0.65	M0.9	45	5.2	6.4	3	2
0.67	S0.9	45	5.4	6.6	3	2
0.7	M1	45	5.6	6.9	3	2
0.74	S1	45	5.9	7.3	3	2
0.9	M1.2	45	7.2	8.8	3	2
0.94	S1.2	48	7.5	9.2	3	2
1.05	M1.4	48	8.4	10.3	3	2
1.09	S1.4	48	8.7	10.7	3	2
1.19	M1.6	48	9.5	11.7	3	2
1.39	M1.8	52	11.1	13.6	4	2
1.54	M2	55	12.3	15.1	4	2
1.98	M2.5	55	15.8	19.4	4	2

ID

- 182863
- 188023
- 182864
- 188024
- 182865
- 188025
- 182866
- 188026
- 182867
- 188027
- 182868
- 182869
- 182870
- 182871

Ø d <sub>1</sub>	D <sub>1</sub> mm	l <sub>1</sub> mm	l <sub>2</sub> mm	l <sub>3</sub> mm	d <sub>2</sub> h6 mm	
2.15	UNC4	63	12.9	19.4	4	2
2.45	M3	65	14.7	22.1	4	2
2.65	UNC6	68	15.9	23.9	4	2
2.85	M3.5	68	17.1	25.7	4	2
3.25	M4	74	19.5	29.3	6	2
3.95	UNF10	78	23.7	35.6	6	2
4.1	M5	80	24.6	36.9	6	2
4.9	M6	84	29.4	44.1	6	2
5	UNC1/4	84	30	45	6	2
5.4	UNF1/4	88	32.4	48.6	6	2

ID

- 190326
- 190321
- 190327
- 190322
- 190323
- 190329
- 190324
- 190325
- 190328
- 190330

# Vollhartmetall-Spiralbohrer

## Solid carbide twist drills

VHM  
CAR



HBK  
HEK

sur demande  
auf Anfrage  
on request  
su richiesta  
sobre pedido  
no saakazy

							F313VS	F285VS	F286VS			
<p><b>F313VS</b></p> <p>11 12 13 14 15 21 22 23 24 41 61 63 71 72 73 74</p> <p><b>F285VS</b> <b>F286VS</b></p> <p>11 12 13 14 15 21 22 23 24 41 51 61 71 72 73 74 93 94</p>												
$\emptyset d_1$ (h <sub>7</sub> )	$d_2$ (h <sub>6</sub> ) mm	$l_1$ mm	$l_2$ mm			ID						
0.88	3	38	8	2	M1	● 158515						
0.9	3	38	10	2	*M1.2	● 159419						
1.08	3	38	10	2	M1.2	● 158516						
1.25	3	38	12	2	M1.4	● 158517						
1.45	3	38	12	2	M1.6	● 158518						
1.65	3	38	12	2	M1.8	● 158519						
1.8	3	38	12	2	M2	● 158520						
1.95	3	38	12	2	UNC2-56	● 158521						
2.3	3	38	16	2	M2.5	● 158522						
2.55	3	38	16	2	UNC4-40	● 158523						
2.8	3	38	16	2	M3	● 158524						
*GWi5000												
$\emptyset d_1$ (m <sub>7</sub> )	$d_2$ (h <sub>6</sub> ) mm	$l_1$ mm	$l_2$ mm	$l_3$ mm			ID					
3.25	6	62	20	14	2	M3.5	● 158527					
3.7	6	62	20	14	2	M4	● 158528					
4.65	6	66	24	17	2	M5	● 158532					
5.55	6	66	28	20	2	M6	● 158534					
7.4	8	79	41	29	2	M8	● 158540					
9.3	10	89	47	35	2	M10	● 158544					
11.2	12	102	55	40	2	M12	● 158546					
$\emptyset d_1$ (m <sub>7</sub> )	$d_2$ (h <sub>6</sub> ) mm	$l_1$ mm	$l_2$ mm	$l_3$ mm			ID					
3.3	6	66	28	23	2	M4	● 160989					
4.2	6	74	36	29	2	M5	● 160990					
5	6	82	44	35	2	M6	● 160991					
6.8	8	91	53	43	2	M8	● 160992					
8.5	10	103	61	49	2	M10	● 160993					
10.2	12	118	71	56	2	M12	● 160994					







# Z | CHALLENGING THREADING



## Schneideisenhalter und Windeisen



### Die stocks and tap wrenches

<b>D5810-</b> Schneideisenhalter für runde Schneideisen nach DIN EN 22568, DIN EN 24230, DIN EN 24231, DIN EN 40434 Die stocks for round dies to DIN EN 22568, DIN EN 24230, DIN EN 24231, DIN EN 40434									<b>D5810-</b>	<b>D5820-</b>
<b>D5820-</b> Windeisen verstellbar DIN 1814 Tap wrenches, adjustable DIN 1814										
DIN EN	M	MF	UNC	UNF	UNEF UNS UN	W	G (BSP)	NPT NPTF R (BSPT)	ID	
No D5810- Ø	Ø	Ø	Ø	Ø	Ø	Ø	Ø	Ø		
1 16 x 5	1 - 2.6	2 - 2.6	No. 1 - 4	No. 1 - 4		1/16" - 3/32"			● 170712	
2 20 x 5	3 - 4	3 - 6	No 5	No 5 - 6		1/8"			● 170713	
3 20 x 7	4.5 - 6		No 6 - 1/4"	No 8 - 1/4"	No 12 - 1/4"	5/32" - 1/4"			● 170714	
4 25 x 9	7 - 9	7 - 9	5/16"	5/16"	5/16"	5/16"		1/16"	● 170715	
5 30 x 11	10 - 11	10 - 11	3/8" - 7/16"	3/8" - 7/16"	3/8" - 7/16"	3/8" - 7/16"	1/8"	1/8"	● 170716	
6 38 x 10		12 - 15		1/2" - 9/16"	1/2" - 9/16"		1/4"		● 170717	
7 38 x 14	12 - 14		1/2" - 9/16"			1/2" - 9/16"		1/4"	● 170718	
8 45 x 14		16 - 20		5/8" - 3/4"	5/8" - 13/16"		3/8" - 1/2"	3/8"	● 170719	
9 45 x 18	16 - 20		5/8" - 3/4"			5/8" - 3/4"		1/2"	● 170720	
10 55 x 16		22 - 26		7/8" - 1"	7/8" - 1"		5/8" - 3/4"		● 170721	
11 55 x 22	22 - 24		7/8" - 1"			7/8" - 1"		3/4"	● 170722	
12 65 x 18		*27 - 36		1 1/8" - 1 3/8"	1 1/16" - 1 3/8"		7/8" - 1"		● 170723	
13 65 x 25	27 - 36		1 1/8" - 1 3/8"			1 1/8" - 1 3/8"		1"	● 170724	
14 75 x 20		38 - 42		1 1/2"	1 7/16" - 1 1/2"		1 1/8" - 1 1/4"		● 170725	
15 75 x 30	39 - 42		1 1/2"			1 1/2" - 1 5/8"			● 170726	
16 90 x 22		45 - 52			1 3/4" - 2"		1 3/8" - 1 3/4"		● 170727	
17 90 x 36	45 - 52		1 3/4" - 2"			1 3/4" - 2"			● 170728	
18 105 x 22		55 - 65					2" - 2 1/4"		● 170729	
*Ausnahme Steigung 3 mm (Nr. 13 verlangen). For 3 mm pitches use No. 13.										
No D5820-	a mm									ID
0	1.9 - 3									● 170730
1	2.5 - 5.5									● 170731
2	4.3 - 8									● 170732
3	5.5 - 12									● 170733
4	9.5 - 15.5									● 170734
5	12.5 - 22.4									● 170735

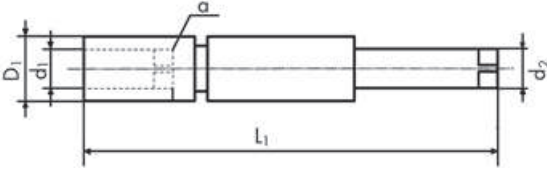

## Verlängerungen

### Tap extension sleeves

D5830- Verlängerungen für Gewindebohrer, ~DIN 377 Tap extension sleeves ~DIN 377		D5840- Verlängerungen für Gewindebohrer Tap extension sleeves		D5830-	D5840-	
						
No	a	L <sub>1</sub>	D <sub>1</sub>	ID		
D5830-	mm	mm	mm			
1	2.1	60	6	● 110571		
2	2.24	70	6	● 110572		
3	2.4	70	6	● 110573		
4	2.5	80	7	● 110574		
5	2.8	90	7	● 110575		
6	3	90	7	● 110579		
7	3.15	95	7	● 110580		
8	3.4	95	8	● 110581		
9	3.55	100	8	● 118706		
10	3.8	100	9	● 118707		
11	4	105	10	● 118708		
12	4.3	105	10	● 118709		
13	4.5	105	10	● 118710		
14	4.9	110	10	● 118711		
15	5	110	11	● 118712		
16	5.5	115	12	● 118713		
17	5.6	110	12	● 118714		
18	6.2	120	14	● 118715		
19	6.3	120	14	● 118716		
20	7	125	15	● 118717		
21	7.1	120	15	● 118718		
22	7.5	120	15	● 118719		
23	8	125	17	● 118720		
24	9	130	19	● 118721		
25	10	140	21	● 110562		
26	11	150	23	● 110563		
27	11.2	145	23	● 110564		
28	12	155	25	● 110565		
29	12.5	160	25	● 110566		
30	14	165	28	● 110567		
31	14.5	175	29	● 110568		
32	16	180	30	● 110569		
33	18	200	33	● 110570		
34	20	220	36	● 110576		
35	22	220	40	● 110577		
36	22.4	240	40	● 110578		
No	a	L <sub>1</sub>	d <sub>2</sub>	d <sub>1</sub>	D <sub>1</sub>	ID
D5840-	mm	mm	mm	mm	mm	
10	2.7	130	6	3.5	7.5	● 169928
11	3.4	130	6	4.5	8.5	● 169929
1	4.9	130	6	6	12	● 142137
2	5.5	130	7	7	13	● 142138
3	6.2	130	8	8	13	● 142139
4	7	130	9	9	17	● 142140
5	8	130	10	10	17	● 142141
6	9	130	11	11	17	● 142142
7	9	130	12	12	20	● 142143
8	11	130	14	14	20	● 142144
9	12	130	16	16	25	● 142145



# BEHERRSCHEN DER KLEINSTEN UND PRÄZISESTEN GEWINDEVERBINDUNGEN

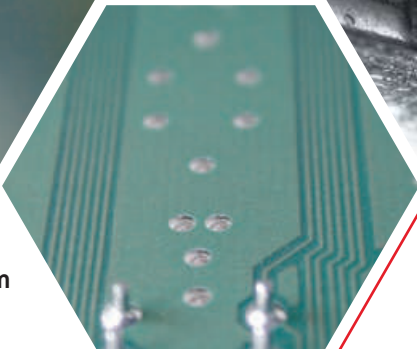
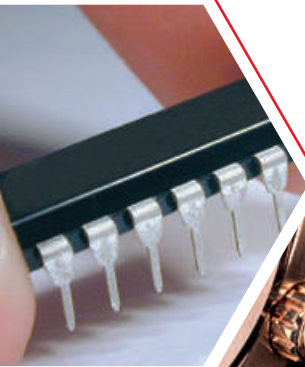

# MASTER THE SMALLEST AND MOST PRECISE THREADED CONNECTIONS

nano



nano



## SPEZIALWERKZEUGE NACH MASS

**Manche Prozesse erfordern massgefertigte Spezialwerkzeuge. DC SWISS kann perfekt auf Ihre Anforderungen abgestimmte Gewindewerkzeuge herstellen.**

Mit unserem Know-how können wir Spezialwerkzeuge herstellen, die besonders hohen Herstelleranforderungen gerecht werden.

Wir helfen Ihnen, mit den geeigneten Werkzeugen auch kühnste Vorhaben umzusetzen. Dazu bietet Ihnen DC SWISS nicht nur ihre Fachkompetenzen und langjährige Erfahrung an, sondern auch eine umfassende Werkzeugpalette und massgeschneiderte Lösungen - für jede Konfiguration, jeden Werkstoff und jede Produktionstechnik, form- und massunabhängig. Denn DC SWISS ist schon heute gut gerüstet für das, was in Zukunft immer wichtiger wird: die individuelle Fertigung.

**MEDIZINTECHNIK  
MEDICAL**

**LUFT- UND RAUMFAHRT  
AEROSPACE**

**SONDERLÖSUNGEN  
CUSTOMISED SOLUTIONS**





## SPECIAL TOOLS ON DEMAND

**Some processes require special on demand tools. DC SWISS can create custom-made threading tools to meet your requirements.**

With our expertise, we can create on demand tools that meet the highest market requirements.

To enable you to create the most audacious and varied assemblies that are best suited to every situation, DC SWISS offers you access to its extensive expertise. Tools are, after all, essential items. They need to adapt to every configuration, every material and all production techniques. Shapes and sizes are no longer constraining factors. DC SWISS develops tools as a matter of course, because custom-made orders are becoming increasingly commonplace.

**AUTOMOTIVE  
AUTOMOTIVE**

**UHRENINDUSTRIE  
WATCHMAKING**



nano





# SPEZIFIZIERUNGEN — SPECIFICATIONS

## TAN



## TAZ



## FA



- Erstklassisches Basismaterial HSSE-PM
- Genauigkeit und Wiederholbarkeit des Werkzeuges durch Fertigung in einer einzigen Aufspannung
- Reinigen, bürsten oder polieren von 100 % der Werkzeuge
- Optimale Beschichtung, angepasst an jede Geometrie
- Top quality HSSE-PM raw material
- Accuracy and repeatability of the tool by manufacturing in a single clamping operation
- Cleaning, brushing or polishing of 100 % of the tools
- Optimal coating adapted to each geometry

## TAN40



- Für Durchgangslöcher  $< 2 \times D$
- For through holes  $< 2 \times D$

## TAN50



- Für Sacklöcher  $< 2 \times D$
- For blind holes  $< 2 \times D$

### Anwendung

Für leicht zu bearbeitende Werkstoffe, Stähle, Messing, Gelbgold, Silber

### Application

For easy-to-machine materials, steels, brass, yellow gold, silver

## TAN40VS



- Vielseitige "VS"-Verschleisschutzschicht für hohe Standzeiten in der Serienproduktion
- Versatile "VS" wear-protective coating for long tool life in series production

## TAN50VS



## TAZ40VS



- Für Durchgangslöcher  $< 2 \times D$
- Mit einem langen, an die Steigung angepassten Anschnitt, für ein besseres Eindringen in das Material
- For through holes  $< 2 \times D$
- With a long chamfer adapted to the pitch, for a better penetration into the material

## TAZ50VS



- Für Sacklöcher  $< 2 \times D$
- For blind holes  $< 2 \times D$

### Anwendung

Für zähe Werkstoffe wie Nickellegierungen, Titanlegierungen, legierte Edelmetalle

### Application

For tough materials such as nickel alloys, titanium alloys, alloyed precious materials



- Spezifische "VS"-Beschichtung der neuesten Generation, angepasst an die Geometrie des Werkzeugs
- Specific "VS" coating of the latest generation adapted to the geometry of the tool

## SPEZIFIZIERUNGEN — SPECIFICATIONS

### FA80VS



- Für Durchgangs- und Sacklöcher  $< 2.5 \times D$
- Mit extra-kurzem  $1.5 \times P$ -Einlauf (für Gewinde bis nahe dem Bohrungsgrund)

- For through and blind holes  $< 2.5 \times D$
- With extra-short chamfer  $1.5 \times P$  (for threads close to the bottom of the core hole)

### FA83VS



- Für Durchgangs- und Sacklöcher  $< 2.5 \times D$
- Mit kurzem Anschnitt  $2.5 \times P$

- For through and blind holes  $< 2.5 \times D$
- With short chamfer  $2.5 \times P$

#### Anwendung

- Für jede Art von Werkstoffen mit einer Bruchdehnung  $> 5 \%$
- Polygon mit 4 Druckstollen ab  $\varnothing 0.5 \text{ mm}$
- Verbesserte Ausreissfestigkeit des Gewindes

#### Application

- For any type of material with an elongation  $> 5 \%$
- Polygon made up of 4 lobes from  $\varnothing 0.5 \text{ mm}$
- Improved thread tensile strength



- Vielseitige "VS"-Verschleisschutzschicht für hohe Standzeiten in der Serienproduktion

- Versatile "VS" wear-protective coating for long tool life in series production

## SPEZIFIZIERUNGEN — SPECIFICATIONS

### CMS



### CFA



- Hartmetallsorte angepasst für Härte und Torsionsfestigkeit
- Präzision und Wiederholgenauigkeit des Werkzeugs durch Fertigung in einer einzigen Aufspannung
- Unübertroffene Oberflächenqualität
- Hard Metal grade suitable for its hardness and torsional strength
- Precision and repeatability of the tool by manufacturing in a single clamping operation
- Unsurpassed surface quality

### CMS50



### CMS50VS



- Für Durchgangs- und Sacklöcher  $< 3 \times D$
- Mit revolutionärer Anschnittgeometrie für optimale Materialdurchdringung
- For through and blind holes  $< 3 \times D$
- With a revolutionary chamfer geometry for optimal material penetration

#### Anwendung

- Für spröde Werkstoffe wie Messing kurzspanend, Grauguss, Cube2, Aluminiumlegierung mit Si  $> 5 \%$
- Spezifische "VS"-Beschichtung der neuesten Generation, angepasst an die Geometrie des Werkzeugs

#### Application

- For brittle materials like short chip brass, grey cast iron, Cube2, aluminium alloy with Si  $> 5 \%$
- Specific "VS" coating of the latest generation adapted to the geometry of the tool



### CFA80VS



- Für Durchgangs- und Sacklöcher  $< 2.5 \times D$
- Mit extra-kurzem 1.5 x P-Einlauf (für Gewinde bis nahe dem Bohrungsgrund)
- For through and blind holes  $< 2.5 \times D$
- With extra-short chamfer 1.5 x P (for threads close to the bottom of the core hole)

### CFA83VS



- Für Durchgangs- und Sacklöcher  $< 2.5 \times D$
- Mit kurzem Einlauf 2.5 x P
- For through and blind holes  $< 2.5 \times D$
- With short chamfer 2.5 x P

#### Anwendung

- Für jede Art von Nichteisen-Metallen mit einer Bruchdehnung  $> 3 \%$
- Für Werkstoffe wie Aluminium- und Kupferlegierungen, Gelb- und Rotgold, Silber, etc

#### Application

- For any type of non-ferrous material with an elongation  $> 3 \%$
- For materials such as: aluminium and copper alloys, yellow and red gold, silver, etc



- Vielseitige "VS"-Verschleisschutzschicht für hohe Standzeiten in der Serienproduktion
- Versatile "VS" wear-protective coating for long tool life in series production

# KODIERUNG – CODIFICATION

**DC**-Maschinen-Gewindebohrer nano

**DC** Machine taps nano

Beispiel - Example



Normale Werkstoffe	Normal materials	TAN	
Zähe Werkstoffe	Tough materials	TAZ	
Messing	Brass	CMS	
Spiralnuten mit Linksdrall < 27°	< 27° left-hand spiral flutes		40
Spiralnuten mit Rechtsdrall < 27°	< 27° right-hand spiral flutes		50
VS-Verschleisschutzschicht, generell	VS wear-protective coating, general		VS
Spezialausführung	Special execution		SP

Baumasse nach DC-Werksnorm

General dimensions as per DC standards

Für den Einsatz gemäss DC-Anwendungstabelle für DC-Gewindebohrer nano

For use as per DC application chart for DC taps nano

**DC**-Maschinen-Gewindeformer nano

**DC** Machine thread formers nano

Beispiel - Example



Gewindeformer nano aus PM	Thread formers nano in PM	FA	
Gewindeformer nano aus Vollhartmetall	Thread formers nano in solid carbide	CFA	
Anschnitt Form E (1.5 - 2 Gewindegänge)	Lead form E (1.5 - 2 chamfered threads)		80
Anschnitt Form C (2 - 3 Gewindegänge)	Lead form C (2 - 3 chamfered threads)		83
VS-Verschleisschutzschicht, generell	VS wear-protective coating, general		VS
Spezialausführung	Special execution		SP

Baumasse nach DC-Werksnorm

General dimensions as per DC standards

Für den Einsatz gemäss DC-Anwendungstabelle für DC-Gewindeformer nano

For use as per DC application chart for DC thread formers nano

# PIKTOGRAMME NANO – PICTOGRAPHS NANO



Für Werkstoffgruppen gemäss **DC**-Anwendungstabelle  
For material groups as per **DC** application chart

12	
1.0037	Si37-2 (S235JR)
1.0050	Si50-2 (E295)
1.0060	Si60-2 (E335)
1.5919	15CrNi6
1.7131	16MnCr5

22	
1.4301	X5CrNi18-10
1.4406	X2CrNiMoN17-12-2
1.4435	X2CrNiMo18-14-3
1.4541	X6CrNiTi18-10
1.4571	X6CrNiMoTi17-12-2



Verstärkter Schaft gemäss DIN 371  
Reinforced shank as per DIN 371



Verstärkter Schaft gemäss DC-Werksnorm  
Reinforced shank as per DC standards



HSSE-PM  
HSSE-PM



Lagerartikel  
Stock item



Vollhartmetall  
Solid Carbide



Kurzfristig lieferbar  
Available at short notice



Anzahl Spannuten (Z)  
Number of flutes (Z)



Ab Lager lieferbar solange Vorrat  
Available from stock, while stock lasts



Spiralnuten mit 20° Linksdrall  
20° left-hand spiral flutes



Spiralnuten mit 25° Rechtsdrall  
25° right-hand spiral flutes



Gewindeformer  
Thread former



Durchgangsloch < 2 x D, langspannende Werkstoffe  
Through hole < 2 x D, long chipping materials



Sackloch < 2 x D, langspannende Werkstoffe  
Blind hole < 2 x D, long chipping materials



Durchgangs- und Sackloch < 2.5 x D, kurzspannende Werkstoffe  
Through / blind hole < 2.5 x D, short chipping materials



Durchgangs- und Sackloch < 3 x D, kurzspannende Werkstoffe  
Through / blind hole < 3 x D, short chipping materials



2 - 3 Gewindegänge, Form C  
2 - 3 chamfered threads, form C



3.5 - 5 Gewindegänge, Form D  
3.5 - 5 chamfered threads, form D



1.5 - 2 Gewindegänge, Form E  
1.5 - 2 chamfered threads, form E



Toleranzklasse 4H  
Tolerance class 4H



Toleranzklasse ISO 2 6H  
Tolerance class ISO 2 6H



DC-"VS"-Verschleisschutzschicht für den allgemeinen Einsatz  
DC "VS" wear-protective coating for general use



DC-"VX"-Verschleisschutzschicht für rostfreie Stähle und Nickellegierungen  
DC "VX" wear-protective coating for stainless steels and nickel alloys

## GEWINDEBOHRER NANO THREAD TAPS NANO

**DC** -Anwendungsgruppen

**DC** Material classification

Werkstoff-Gruppen Material groups		Werkstoffbezeichnung	Material designation	Härte Hardness (HB)	Festigkeit Tensile strength Rm (N/mm <sup>2</sup> )	Dehnung Elongation A (%)
<b>10</b> Stahl Steels	11	Automatenstahl	Free-cutting steels	< 200	< 700	< 10
	12	Baustahl, Einsatzstahl	Structural, cementation steels	< 200	< 700	< 30
	13	Kohlenstoffstahl	Carbon steels	< 300	< 1000	< 20
	14	Stahl legiert < 850 N/mm <sup>2</sup>	Alloy steels < 850 N/mm <sup>2</sup>	< 250	< 850	< 30
	15	Stahl legiert / vergütet > 850 - < 1150 N/mm <sup>2</sup>	Alloy steels hard. / temp. > 850 - < 1150 N/mm <sup>2</sup>	> 250	> 850	< 30
	16	Hochfester Stahl ≤ 44 HRC	High tensile alloy steels ≤ 44 HRC	> 250	> 850	< 12
	17	Stahl vergütet > 44 - ≤ 54 HRC	Alloy steels tempered > 44 - ≤ 54 HRC	> 410	> 1400	< 2
	18	Stahl gehärtet > 54 - ≤ 63 HRC	Alloy steels hardened > 54 - ≤ 63 HRC	> 560	> 1980	< 2
<b>20</b> Rostfreier Stahl Stainless steels	21	Rostfreier Stahl, geschwefelt	Free machining stainless steels	< 250	< 850	< 25
	22	Austenitisch	Austenitic stainless steels	< 250	< 850	> 20
	23	Ferritisch, martensitisch < 850 N/mm <sup>2</sup>	Ferritic and martensitic < 850 N/mm <sup>2</sup>	< 250	< 850	> 20
	24	Ferritisch, martensitisch > 850 - < 1150 N/mm <sup>2</sup>	Ferritic and martensitic > 850 - < 1150 N/mm <sup>2</sup>	> 250	> 850	> 15
<b>30</b> Guss Cast iron	31	Grauguss	Cast iron	< 250	< 850	< 10
	32	Kugelgraphitguss, Temporguss	Spheroidal graphite + malleable cast iron	< 250	< 850	> 10
<b>40</b> Titan Titanium	41	Reintitan	Pure titanium	< 250	< 850	> 20
	42	Titanlegierung	Titanium alloys	> 250	> 850	< 20
<b>50</b> Nickel Nickel	51	Nickellegierung 1 ≤ 850 N/mm <sup>2</sup>	Nickel alloys 1 ≤ 850 N/mm <sup>2</sup>	< 250	< 850	> 25
	52	Nickellegierung 2 > 850 - ≤ 1150 N/mm <sup>2</sup>	Nickel alloys 2 > 850 - ≤ 1150 N/mm <sup>2</sup>	> 250	> 850	< 25
	53	Nickellegierung 3 > 1150 - ≤ 1600 N/mm <sup>2</sup>	Nickel alloys 3 > 1150 - ≤ 1600 N/mm <sup>2</sup>	> 340	> 1150	< 20
<b>60</b> Kupfer Copper	61	Reinkupfer (Elektrolytkupfer)	Pure copper (electrolytic copper)	< 120	< 400	> 12
	62	Messing, Bronze, Rotguss (kurzspanend)	Short chip brass, phosphor bronze, gun metal	< 200	< 700	< 12
	63	Messing (langspanend)	Long chip brass	< 200	< 700	> 12
	64	Messing bleifrei	Lead free brass	< 220	< 700	> 15
<b>70</b> Aluminium Magnesium Aluminium Magnesium	71	Al unlegiert	Al unalloyed	< 100	< 350	> 15
	72	Al legiert Si < 1.5 %	Al alloyed Si < 1.5 %	< 150	< 500	> 15
	73	Al legiert Si > 1.5 % - < 10 %	Al alloyed Si > 1.5 % - < 10 %	< 120	< 400	< 15
	74	Al legiert Si > 10 %, Mg-Legierungen	Al alloyed Si > 10 %, Mg-alloys	< 120	< 400	< 10
<b>80</b> Kunststoff Plastic compounds	81	Thermoplaste	Thermoplastics	-	-	-
	82	Duroplaste	Duroplastics	-	-	-
	83	Faserverstärkte Kunststoffe	Glass fibre reinforced plastics	-	-	-
<b>90</b> Edelmetalle Precious metals	91	Gelbgold	Yellow gold	-	-	-
	92	Rotgold	Red gold	-	-	-
	93	Weissgold	White gold	-	-	-
	94	Silber	Silver	-	-	-



















	TAN				TAZ	
<b>Merkmale</b> <b>Characteristics</b>		 VS		 VS		 VS
<b>Lochart</b> <b>Hole type</b>						
	TAN40	TAN40VS	TAN50	TAN50VS	TAZ40	TAZ40VS
<b>M</b> <b>4H / 6H</b> <b>ISO DIN 14</b> <b>ISO DIN 13</b> <b>DC ~DIN 371</b>	338	338	338	338	339	339
<b>MF</b> <b>4H / 6H</b> <b>ISO DIN 13</b> <b>DC ~DIN 371</b>	341	341	341	341	342	342
<b>UNC</b> <b>2B</b> <b>ASME B1.1</b> <b>DC ~DIN 371</b>	344	344	344	344	345	345
<b>3B</b> <b>ASME B1.1</b> <b>DC ~DIN 371</b>	344	344	344	344	345	345
<b>UNF</b> <b>2B</b> <b>ASME B1.1</b> <b>DC ~DIN 371</b>	347	347	347	347	348	348
<b>3B</b> <b>ASME B1.1</b> <b>DC ~DIN 371</b>	347	347	347	347	348	348
<b>S</b> <b>NIHS</b> <b>NIHS 06 - 10</b> <b>DC</b>	350	350	350	350	351	351
<b>SF</b> <b>NIHS</b> <b>NIHS 06-10</b> <b>Fine Thread</b> <b>DC</b>	353	353	353	353	354	354
<b>SL</b> <b>Safelock</b> <b>SL 15 - 01</b> <b>DC</b>	356	356	356	356	357	357





TAZ		CMS	
 R25	 R25  VS	 R12	 R12  VS
			
			
TAZ50	TAZ50VS	CMS50	CMS50VS
339	339	340	340
342	342	343	343
345	345	346	346
345	345	346	346
348	348	349	349
348	348	349	349
351	351	352	352
354	354	355	355
357	357	358	358

# TAN

TAN40



62 63 91

TAN40VS



11 12 13 14 32 62  
63 71 72 73 74 81  
93

TAN50



62 63 91

TAN50VS



11 12 13 14 32 62  
63 71 72 73 74 81  
93

TAN40

TAN40VS

TAN50

TAN50VS

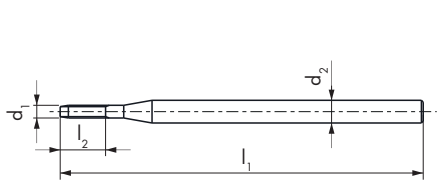

4H

4H

4H

4H

$\emptyset d_1$ M	P mm	$l_1$ mm	$l_2$ mm	$d_2$ mm		
0.5	0.125	25	1.5	2	3	$\Delta 0.41$
0.6	0.15	25	1.8	2	3	$\Delta 0.5$
0.7	0.175	25	2.1	2	3	$\Delta 0.58$
0.8	0.2	25	2.4	2	3	$\Delta 0.66$
0.9	0.225	25	2.7	2	3	$\Delta 0.74$
1	0.25	40	3.0	2.5	3	0.75
1.2	0.25	40	3.6	2.5	3	0.95
1.4	0.3	40	4.2	2.5	3	1.1

$\Delta$  4H5H  $\rightarrow$  4H6H = +0.02 mm

ID	ID	ID	ID
● 161817	● 161748	● 161818	● 161749
● 152512	● 152511	● 152545	● 151766
● 152516	● 152515	● 152548	● 152547
● 152520	● 152519	● 152552	● 152551
● 152524	● 152523	● 152555	● 152554
● 152528	● 152527	● 152558	● 151557
● 152531	● 151463	● 152562	● 152561
● 152534	● 151756	● 152565	● 151757

$\geq M1 - \leq M1.4$

ISO 1  
4H

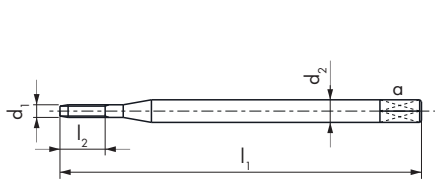

ISO 2  
6H

ISO 2  
6H

ISO 2  
6H

ISO 2  
6H

$\emptyset d_1$ M	P mm	$l_1$ mm	$l_2$ mm	$d_2$ mm	a mm		
1.6	0.35	40	4.8	2.5		3	1.25
1.8	0.35	40	5.4	2.5		3	1.45
2	0.4	45	8	2.8	2.1	3	1.6
2.3	0.4	45	9	2.8	2.1	3	1.9
2.5	0.45	50	10	2.8	2.1	3	2.05
2.6	0.45	50	10	2.8	2.1	3	2.15

ID	ID	ID	ID
● 152538	● 152537	● 152569	● 152568
● 193841	● 151461	● 193915	● 193952
● 152542	● 152541	● 152573	● 152572
● 193842	● 193878	● 193916	● 193953
● 193843	● 193879	● 193917	● 193954
● 193844	● 193880	● 193918	● 193955

# TAZ

TAZ40



TAZ40VS



TAZ50



TAZ50VS



TAZ40

TAZ40VS

TAZ50

TAZ50VS

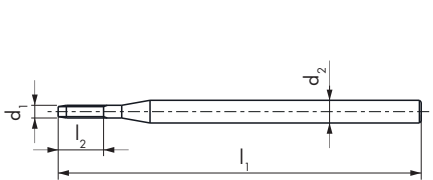

4H

4H

4H

4H

Ø d <sub>1</sub> M	P mm	l <sub>1</sub> mm	l <sub>2</sub> mm	d <sub>2</sub> mm		
0.5	0.125	25	1.5	2	3	Δ0.41
0.6	0.15	25	1.8	2	3	Δ0.5
0.7	0.175	25	2.1	2	3	Δ0.58
0.8	0.2	25	2.4	2	3	Δ0.66
0.9	0.225	25	2.7	2	3	Δ0.74
1	0.25	40	3	2.5	3	0.75
1.2	0.25	40	3.6	2.5	3	0.95
1.4	0.3	40	4.2	2.5	3	1.1

Δ 4H5H → 4H6H = +0.02 mm

≥ M1 - ≤ M1.4

ISO 1  
4H

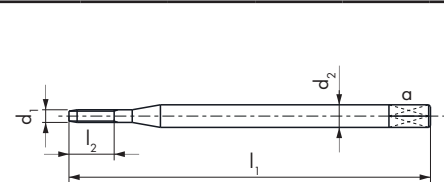

ISO 2  
6H

ISO 2  
6H

ISO 2  
6H

ISO 2  
6H

Ø d <sub>1</sub> M	P mm	l <sub>1</sub> mm	l <sub>2</sub> mm	d <sub>2</sub> mm	a mm		
1.6	0.35	40	4.8	2.5		3	1.25
1.8	0.35	40	5.4	2.5		3	1.45
2	0.4	45	8	2.8	2.1	3	1.6
2.3	0.4	45	9	2.8	2.1	3	1.9
2.5	0.45	50	10	2.8	2.1	3	2.05
2.6	0.45	50	10	2.8	2.1	3	2.15

ID

ID

ID

ID

1.6	0.35	40	4.8	2.5		3	1.25	● 194002	● 194067	● 194127	● 194189
1.8	0.35	40	5.4	2.5		3	1.45	● 194003	● 194068	● 194128	● 194190
2	0.4	45	8	2.8	2.1	3	1.6	● 194004	● 194947	● 194129	● 179266
2.3	0.4	45	9	2.8	2.1	3	1.9	● 194005	● 194069	● 194130	● 194191
2.5	0.45	50	10	2.8	2.1	3	2.05	● 194006	● 194070	● 194131	● 194192
2.6	0.45	50	10	2.8	2.1	3	2.15	● 194007	● 194071	● 194132	● 194193

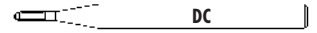

# CMS

CMS50



62 63 93

CMS50VS



31 62 63 73 74 83  
93

CMS50

CMS50VS

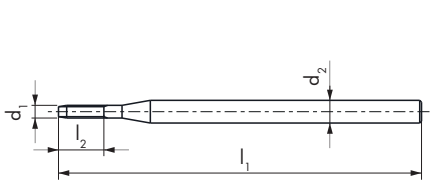

4H

4H

$\emptyset d_1$ M	P mm	$l_1$ mm	$l_2$ mm	$d_2$ h5 mm		
0.3	0.08	32	1.1	1.5	3	0.23
0.35	0.09	32	1.3	1.5	3	0.28
0.4	0.1	32	1.5	1.5	3	$\Delta 0.32$
0.5	0.125	32	1.8	1.5	3	$\Delta 0.41$
0.6	0.15	32	2.2	1.5	3	$\Delta 0.5$
0.7	0.175	32	2.6	1.5	3	$\Delta 0.58$
0.8	0.2	32	3	1.5	3	$\Delta 0.66$
0.9	0.225	32	3.3	1.5	3	$\Delta 0.74$
1	0.25	32	3.7	2	3	0.75
1.2	0.25	32	4.5	2	3	0.95
1.4	0.3	32	5.2	2	3	1.1

ID

ID

● 193639	● 193702
● 193640	● 193703
● 193641	● 193704
● 193642	● 193705
● 193643	● 193706
● 193644	● 193707
● 193645	● 193708
● 193646	● 193709
● 193647	● 193710
● 193648	● 193711
● 193649	● 193712

4H5H → 4H6H = +0.02 mm

≥ M1 - ≤ M1.4

ISO 1  
4H

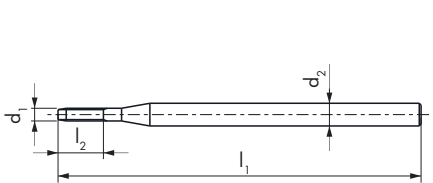

ISO 2  
6H

ISO 2  
6H

$\emptyset d_1$ M	P mm	$l_1$ mm	$l_2$ mm	$d_2$ h5 mm		
1.6	0.35	32	6	2	3	1.25
1.8	0.35	32	6.7	2	3	1.45
2	0.4	39	7.5	3	3	1.6
2.3	0.4	39	8.6	3	3	1.9
2.5	0.45	39	9.3	3	3	2.05
2.6	0.45	39	9.7	3	3	2.15

ID

ID

● 193650	● 193713
● 193651	● 193714
● 193652	● 193715
● 193653	● 193716
● 193654	● 193717
● 193655	● 193718



PM

DC - DIN 371

## TAN

TAN40



62 63 91

TAN40VS



VS

11 12 13 14 32 62  
63 71 72 73 74 81  
93

TAN50



62 63 91

TAN50VS



VS

11 12 13 14 32 62  
63 71 72 73 74 81  
93

TAN40

TAN40VS

TAN50

TAN50VS

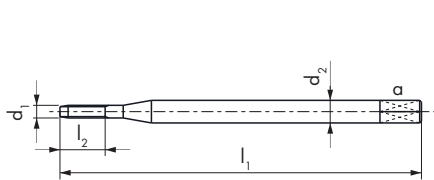

ISO 1  
4H

ISO 1  
4H

ISO 1  
4H

ISO 1  
4H

Ø d <sub>1</sub> MF	P mm	l <sub>1</sub> mm	l <sub>2</sub> mm	d <sub>2</sub> mm	a mm		
1.4	0.2	40	4.2	2.5		3	1.2
1.6	0.2	40	4.8	2.5		3	1.4
1.8	0.2	40	5.4	2.5		3	1.6
2	0.2	45	6	2.8	2.1	3	1.8
2	0.25	45	6	2.8	2.1	3	1.75
2.2	0.2	45	6.6	2.8	2.1	3	2
2.2	0.25	45	6.6	2.8	2.1	3	1.95
2.3	0.2	45	6.9	2.8	2.1	3	2.1
2.3	0.25	45	6.9	2.8	2.1	3	2.05
2.5	0.2	50	7.5	2.8	2.1	3	2.3
2.5	0.25	50	7.5	2.8	2.1	3	2.25

ID

ID

ID

ID

• 170390	• 193881	• 170393	• 156730
• 193845	• 193882	• 193919	• 193956
• 193846	• 193883	• 193920	• 180810
• 193847	• 193884	• 193921	• 184999
• 193848	• 193885	• 193922	• 182944
• 193849	• 193886	• 193923	• 179593
• 193850	• 193887	• 193924	• 193957
• 193851	• 193888	• 193925	• 193958
• 193852	• 193889	• 193926	• 193959
• 193853	• 193890	• 193927	• 193960
• 193854	• 193891	• 193928	• 193961

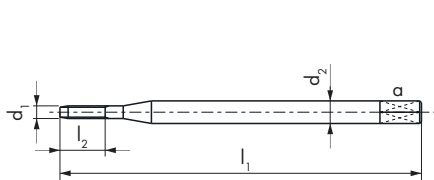

ISO 2  
6H

ISO 2  
6H

ISO 2  
6H

ISO 2  
6H

Ø d <sub>1</sub> MF	P mm	l <sub>1</sub> mm	l <sub>2</sub> mm	d <sub>2</sub> mm	a mm		
2.5	0.35	50	7.5	2.8	2.1	3	2.15
2.6	0.35	50	7.8	2.8	2.1	3	2.25

ID

ID

ID

ID

• 193855	• 193892	• 193929	• 193962
• 193856	• 193893	• 193930	• 193963



PM

DC - DIN 371

## TAZ

TAZ40



TAZ40VS



VS



TAZ50



TAZ50VS



VS



TAZ40

TAZ40VS

TAZ50

TAZ50VS

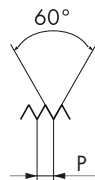
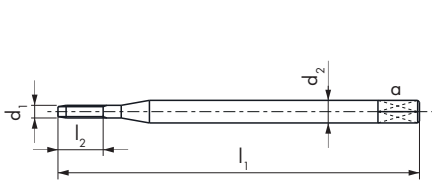

Ø d <sub>1</sub> MF	P mm	l <sub>1</sub> mm	l <sub>2</sub> mm	d <sub>2</sub> mm	a mm		
1.4	0.2	40	4.2	2.5		3	1.2
1.6	0.2	40	4.8	2.5		3	1.4
1.8	0.2	40	5.4	2.5		3	1.6
2	0.2	45	6	2.8	2.1	3	1.8
2	0.25	45	6	2.8	2.1	3	1.75
2.2	0.2	45	6.6	2.8	2.1	3	2
2.2	0.25	45	6.6	2.8	2.1	3	1.95
2.3	0.2	45	6.9	2.8	2.1	3	2.1
2.3	0.25	45	6.9	2.8	2.1	3	2.05
2.5	0.2	50	7.5	2.8	2.1	3	2.3
2.5	0.25	50	7.5	2.8	2.1	3	2.25

ID	ID	ID	ID
● 194008	● 194950	● 194133	● 194194
● 194009	● 194072	● 194134	● 181665
● 194010	● 194073	● 194135	● 190047
● 194011	● 194949	● 194136	● 194195
● 194012	● 194948	● 194137	● 185307
● 194013	● 194074	● 194138	● 194196
● 194014	● 194075	● 194139	● 194197
● 194015	● 194076	● 194140	● 194198
● 194016	● 194077	● 194141	● 194199
● 194017	● 194078	● 194142	● 194200
● 194018	● 194951	● 194143	● 194201

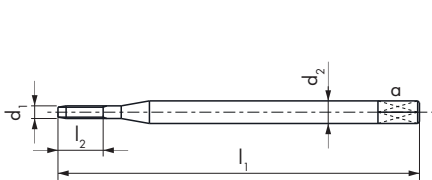

Ø d <sub>1</sub> MF	P mm	l <sub>1</sub> mm	l <sub>2</sub> mm	d <sub>2</sub> mm	a mm		
2.5	0.35	50	7.5	2.8	2.1	3	2.15
2.6	0.35	50	7.8	2.8	2.1	3	2.25

ID	ID	ID	ID
● 194019	● 194079	● 194144	● 194202
● 194020	● 194080	● 194145	● 194203

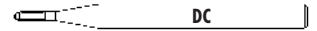

## CMS

CMS50



62 63 93

CMS50VS



31 62 63 73 74 83 93

CMS50

CMS50VS

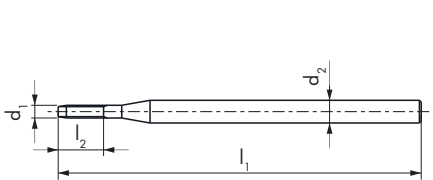

Ø d <sub>1</sub> MF	P mm	l <sub>1</sub> mm	l <sub>2</sub> mm	d <sub>2</sub> h5 mm			ID	ID
1.4	0.2	32	5.2	2	3	1.2	● 193656	● 193719
1.6	0.2	32	6	2	3	1.4	● 193657	● 193720
1.8	0.2	32	6.7	2	3	1.6	● 193658	● 193721
2	0.2	39	7.5	3	3	1.8	● 193659	● 193722
2	0.25	39	7.5	3	3	1.75	● 193660	● 193723
2.2	0.2	39	8.2	3	3	2	● 193661	● 193724
2.2	0.25	39	8.2	3	3	1.95	● 193662	● 193725
2.3	0.2	39	8.6	3	3	2.1	● 193663	● 193726
2.3	0.25	39	8.6	3	3	2.05	● 193664	● 193727
2.5	0.2	39	9.3	3	3	2.3	● 193665	● 193728
2.5	0.25	39	9.3	3	3	2.25	● 193666	● 193729

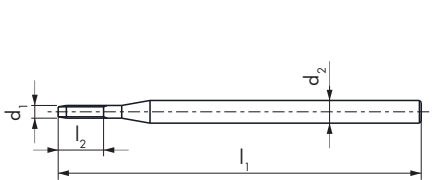

Ø d <sub>1</sub> MF	P mm	l <sub>1</sub> mm	l <sub>2</sub> mm	d <sub>2</sub> h5 mm			ID	ID
2.5	0.35	39	9.3	3	3	2.15	● 193667	● 193730
2.6	0.35	39	9.7	3	3	2.25	● 193668	● 193731

DINO



PM

DC – DIN 371

## TAN

TAN40



62 63 91

TAN40VS



VS

11 12 13 14 32 62  
63 71 72 73 74 81  
93

TAN50



62 63 91

TAN50VS



VS

11 12 13 14 32 62  
63 71 72 73 74 81  
93

TAN40

TAN40VS

TAN50

TAN50VS

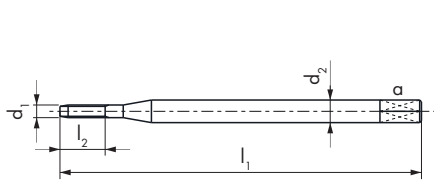

2B

2B

2B

2B

$\emptyset d$ UNC	P TPI	$d_1$ mm	$l_1$ mm	$l_2$ mm	$d_2$ mm	a mm		
1	64	1.85	40	5.6	2.5		3	1.45
2	56	2.18	45	9	2.8	2.1	3	1.75
3	48	2.51	50	10	2.8	2.1	3	2

ID

ID

ID

ID

● 193857	● 193894	● 193931	● 193964
● 193858	● 193895	● 193932	● 193965
● 193859	● 193896	● 193933	● 193966

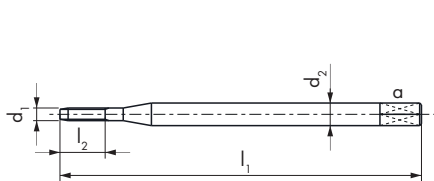

3B

3B

3B

3B

$\emptyset d$ UNC(J)	P TPI	$d_1$ mm	$l_1$ mm	$l_2$ mm	$d_2$ mm	a mm		
1	64	1.85	40	5.6	2.5		3	1.45
2	56	2.18	45	9	2.8	2.1	3	1.75
3	48	2.51	50	10	2.8	2.1	3	2

ID

ID

ID

ID

● 193860	● 193897	● 193934	● 193967
● 193861	● 193898	● 193935	● 193968
● 193862	● 193899	● 193936	● 193969



## TAZ

TAZ40



TAZ40VS



TAZ50



TAZ50VS



TAZ40

TAZ40VS

TAZ50

TAZ50VS

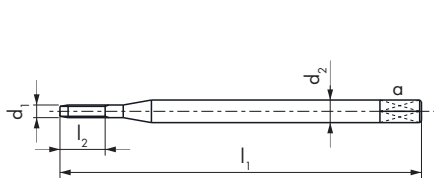

$\emptyset d_1$ UNC	P TPI	$d_1$ mm	$l_1$ mm	$l_2$ mm	$d_2$ mm	a mm		
1	64	1.85	40	5.6	2.5		3	1.45
2	56	2.18	45	9	2.8	2.1	3	1.75
3	48	2.51	50	10	2.8	2.1	3	2

ID	ID	ID	ID
● 194021	● 194081	● 194146	● 194204
● 194022	● 194082	● 194147	● 194205
● 194023	● 194083	● 194148	● 194206

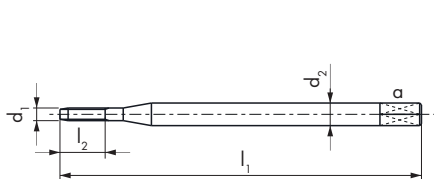

$\emptyset d_1$ UNC(J)	P TPI	$d_1$ mm	$l_1$ mm	$l_2$ mm	$d_2$ mm	a mm		
1	64	1.85	40	5.6	2.5		3	1.45
2	56	2.18	45	9	2.8	2.1	3	1.75
3	48	2.51	50	10	2.8	2.1	3	2

ID	ID	ID	ID
● 194024	● 194084	● 194149	● 194207
● 194025	● 194085	● 194150	● 194208
● 194026	● 194086	● 194151	● 194209

nano

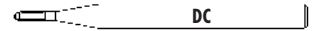

## CMS

CMS50



62 63 93

CMS50VS



31 62 63 73 74 83 93

CMS50

CMS50VS

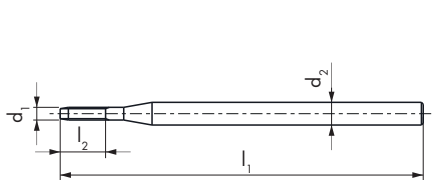

2B

2B

Ø d <sub>1</sub> UNC	P TPI	d <sub>1</sub> mm	l <sub>1</sub> mm	l <sub>2</sub> mm	d <sub>2</sub> h5 mm		
1	64	1.85	32	6.9	2	3	1.45
2	56	2.18	39	8.1	3	3	1.75
3	48	2.51	39	9.4	3	3	2

ID

ID

- |          |          |
|----------|----------|
| ● 193669 | ● 193732 |
| ● 193670 | ● 193733 |
| ● 193671 | ● 193734 |

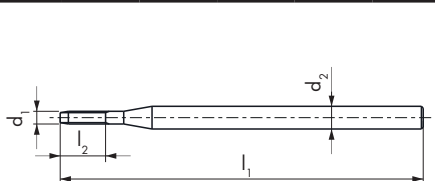

3B

3B

Ø d <sub>1</sub> UNC(J)	P TPI	d <sub>1</sub> mm	l <sub>1</sub> mm	l <sub>2</sub> mm	d <sub>2</sub> h5 mm		
1	64	1.85	32	6.9	2	3	1.45
2	56	2.18	39	8.1	3	3	1.75
3	48	2.51	39	9.4	3	3	2

ID

ID

- |          |          |
|----------|----------|
| ● 193672 | ● 193735 |
| ● 193673 | ● 193736 |
| ● 193674 | ● 193737 |



PM

DC - DIN 371

## TAN

										TAN40	TAN40VS	TAN50	TAN50VS
<p><b>TAN40</b> <b>62 63 91</b></p> <p><b>TAN40VS</b> <b>VS</b> <b>11 12 13 14 32 62 63 71 72 73 74 81 93</b></p> <p><b>TAN50</b> <b>62 63 91</b></p> <p><b>TAN50VS</b> <b>VS</b> <b>11 12 13 14 32 62 63 71 72 73 74 81 93</b></p>													
$\emptyset d_1$ UNF	P TPI	$d_1$ mm	$l_1$ mm	$l_2$ mm	$d_2$ mm	a mm				ID	ID	ID	ID
0	80	1.52	40	4.6	2.5		3	1.2		193863	193900	193937	193970
1	72	1.85	40	5.6	2.5		3	1.5		193864	193901	193938	193971
2	64	2.18	45	9	2.8	2.1	3	1.8		193865	193902	193939	193972
3	56	2.51	50	10	2.8	2.1	3	2.1		193866	193903	193940	193973
$\emptyset d_1$ UNF(J)	P TPI	$d_1$ mm	$l_1$ mm	$l_2$ mm	$d_2$ mm	a mm				ID	ID	ID	ID
0	80	1.52	40	4.6	2.5		3	1.2		193867	193904	193941	193974
1	72	1.85	40	5.6	2.5		3	1.5		193868	193905	193942	193975
2	64	2.18	45	9	2.8	2.1	3	1.8		193869	193906	193943	193976
3	56	2.51	50	10	2.8	2.1	3	2.1		193870	193907	193944	193977

nano



PM

DC - DIN 371

## TAZ

**TAZ40**

**TAZ40VS**

**TAZ50**

**TAZ50VS**

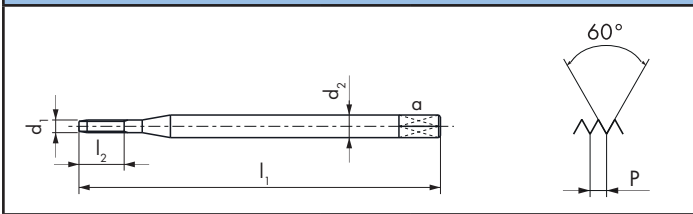
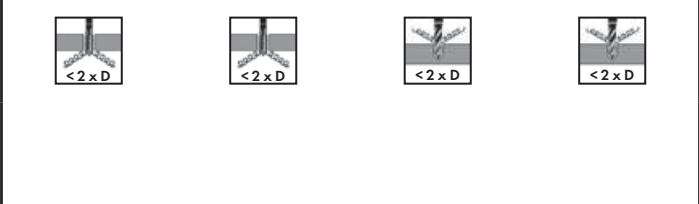

<b>2B</b>	<b>2B</b>	<b>2B</b>	<b>2B</b>

$\emptyset d_1$ UNF	P TPI	$d_1$ mm	$l_1$ mm	$l_2$ mm	$d_2$ mm	a mm		
0	80	1.52	40	4.6	2.5		3	1.2
1	72	1.85	40	5.6	2.5		3	1.5
2	64	2.18	45	9	2.8	2.1	3	1.8
3	56	2.51	50	10	2.8	2.1	3	2.1

ID	ID	ID	ID

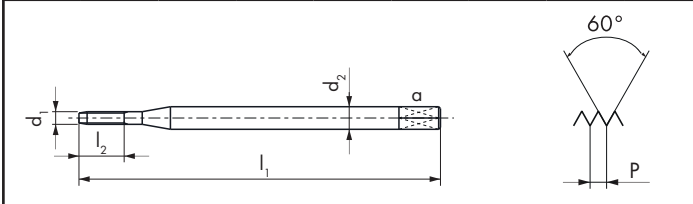

<b>3B</b>	<b>3B</b>	<b>3B</b>	<b>3B</b>
-----------	-----------	-----------	-----------

$\emptyset d_1$ UNF(J)	P TPI	$d_1$ mm	$l_1$ mm	$l_2$ mm	$d_2$ mm	a mm		
0	80	1.52	40	4.6	2.5		3	1.2
1	72	1.85	40	5.6	2.5		3	1.5
2	64	2.18	45	9	2.8	2.1	3	1.8
3	56	2.51	50	10	2.8	2.1	3	2.1

ID	ID	ID	ID

# UNF ASME B1.1



VHM  
CAR

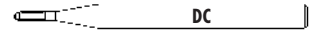

## CMS

CMS50



62 63 93

CMS50VS



31 62 63 73 74 83  
93

CMS50

CMS50VS

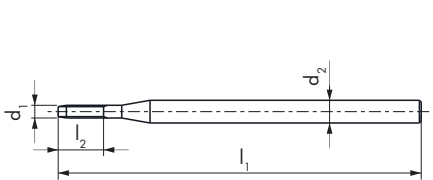

2B

2B

$\emptyset d_1$ UNF	P TPI	$d_1$ mm	$l_1$ mm	$l_2$ mm	$d_2$ h5 mm		
0	80	1.52	32	5.7	2	3	1.2
1	72	1.85	32	6.9	2	3	1.5
2	64	2.18	39	8.1	3	3	1.8
3	56	2.51	39	9.4	3	3	2.1

ID

ID

- |          |          |
|----------|----------|
| ● 193675 | ● 193738 |
| ● 193676 | ● 193739 |
| ● 193677 | ● 193740 |
| ● 193678 | ● 193741 |

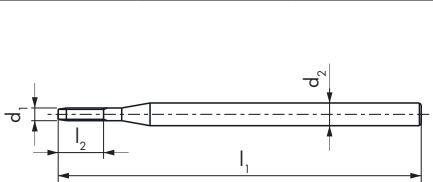

3B

3B

$\emptyset d_1$ UNF(J)	P TPI	$d_1$ mm	$l_1$ mm	$l_2$ mm	$d_2$ h5 mm		
0	80	1.52	32	5.7	2	3	1.2
1	72	1.85	32	6.9	2	3	1.5
2	64	2.18	39	8.1	3	3	1.8
3	56	2.51	39	9.4	3	3	2.1

ID

ID

- |          |          |
|----------|----------|
| ● 193679 | ● 193742 |
| ● 193680 | ● 193743 |
| ● 193681 | ● 193744 |
| ● 193682 | ● 193745 |

nano



PM

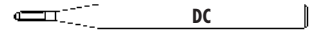

TAN							TAN40	TAN40VS	TAN50	TAN50VS
<p><b>TAN40</b> <b>62 63 91</b></p> <p><b>TAN40VS</b> <b>VS</b>  <b>11 12 13 14 32 62</b>  <b>63 71 72 73 74 81</b>  <b>93</b></p> <p><b>TAN50</b> <b>62 63 91</b></p> <p><b>TAN50VS</b> <b>VS</b>  <b>11 12 13 14 32 62</b>  <b>63 71 72 73 74 81</b>  <b>93</b></p>										
$\varnothing d_1$	P	$l_1$	$l_2$	$d_2$			ID	ID	ID	ID
S	mm	mm	mm	mm						
0.5	0.125	25	1.5	2	3	$\Delta 0.41$	● 161816	● 157021	● 159301	● 158384
0.6	0.15	25	1.8	2	3	$\Delta 0.5$	● 152510	● 152509	● 151567	● 152544
0.7	0.175	25	2.1	2	3	$\Delta 0.58$	● 152514	● 152513	● 151768	● 152546
0.8	0.2	25	2.4	2	3	$\Delta 0.66$	● 152518	● 152517	● 152550	● 152549
0.9	0.225	25	2.7	2	3	$\Delta 0.74$	● 152522	● 152521	● 152553	● 151563
1	0.25	40	3	2.5	3	$\Delta 0.82$	● 152526	● 152525	● 152557	● 152556
1.2	0.25	40	3.6	2.5	3	$\Delta 1.02$	● 152530	● 152529	● 152560	● 152559
1.4	0.3	40	4.2	2.5	3	$\Delta 1.18$	● 152533	● 152532	● 152564	● 152563
$\Delta$ 4H5H $\rightarrow$ 4H6H = +0.02 mm										



PM



## TAZ

TAZ40



TAZ40VS



VS

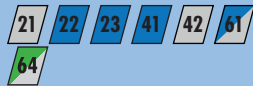

TAZ50



TAZ50VS



VS



TAZ40

TAZ40VS

TAZ50

TAZ50VS

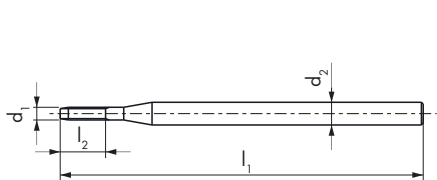

NIHS

NIHS

NIHS

NIHS

$\emptyset d_1$ S	P mm	$l_1$ mm	$l_2$ mm	$d_2$ mm		
0.5	0.125	25	1.5	2	3	$\Delta 0.41$
0.6	0.15	25	1.8	2	3	$\Delta 0.5$
0.7	0.175	25	2.1	2	3	$\Delta 0.58$
0.8	0.2	25	2.4	2	3	$\Delta 0.66$
0.9	0.225	25	2.7	2	3	$\Delta 0.74$
1	0.25	40	3	2.5	3	$\Delta 0.82$
1.2	0.25	40	3.6	2.5	3	$\Delta 1.02$
1.4	0.3	40	4.2	2.5	3	$\Delta 1.18$

$\Delta$  4H5H  $\rightarrow$  4H6H = +0.02 mm

ID	ID	ID	ID
● 193978	● 194043	● 194103	● 194168
● 193979	● 194044	● 194104	● 194169
● 193980	● 194045	● 194105	● 194170
● 193981	● 194046	● 194106	● 188515
● 193982	● 194047	● 194107	● 188521
● 193983	● 194048	● 194108	● 194171
● 193984	● 194049	● 194109	● 194172
● 193985	● 194050	● 194110	● 194173

nano

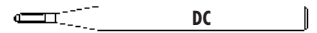

## CMS

CMS50



62 63 93

CMS50VS



31 62 63 73 74 83  
93

CMS50

CMS50VS

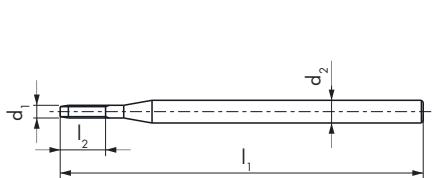

$\emptyset d_1$ S	P mm	$l_1$ mm	$l_2$ mm	$d_2$ h5 mm			ID	ID
0.3	0.08	32	1.1	1.5	3	0.23	● 178257	● 193683
0.35	0.09	32	1.3	1.5	3	0.28	● 178260	● 193684
0.4	0.1	32	1.5	1.5	3	$\Delta 0.32$	● 178263	● 193685
0.5	0.125	32	1.8	1.5	3	$\Delta 0.41$	● 178266	● 193686
0.6	0.15	32	2.2	1.5	3	$\Delta 0.5$	● 178269	● 193687
0.7	0.175	32	2.6	1.5	3	$\Delta 0.58$	● 178272	● 193688
0.8	0.2	32	3	1.5	3	$\Delta 0.66$	● 178275	● 193689
0.9	0.225	32	3.3	1.5	3	$\Delta 0.74$	● 178278	● 193690
1	0.25	32	3.7	2	3	$\Delta 0.82$	● 178281	● 193691
1.2	0.25	32	4.5	2	3	$\Delta 1.02$	● 178284	● 193692
1.4	0.3	32	5.2	2	3	$\Delta 1.18$	● 178287	● 193693

$\Delta$  4H5H  $\rightarrow$  4H6H = +0.02 mm





# TAN

TAN40



62 63 91

TAN40VS



VS

11 12 13 14 32 62  
63 71 72 73 74 81  
93

TAN50



62 63 91

TAN50VS



VS

11 12 13 14 32 62  
63 71 72 73 74 81  
93

TAN40

TAN40VS

TAN50

TAN50VS

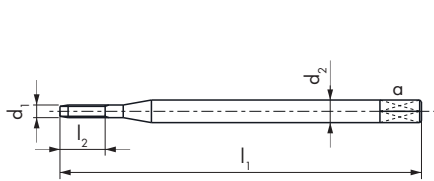

NIHS

NIHS

NIHS

NIHS

$\emptyset d_1$ SF	P mm	$l_1$ mm	$l_2$ mm	$d_2$ mm	a mm		
1.4	0.2	40	4.2	2.5		3	$\Delta 1.26$
1.6	0.2	40	4.8	2.5		3	$\Delta 1.46$
1.8	0.2	40	5.4	2.5		3	$\Delta 1.66$
2	0.2	45	6	2.8	2.1	3	$\Delta 1.86$
2.2	0.2	45	6.6	2.8	2.1	3	$\Delta 2.06$
2.2	0.25	45	6.6	2.8	2.1	3	$\Delta 2.02$
2.5	0.2	50	7.5	2.8	2.1	3	$\Delta 2.36$
2.5	0.25	50	7.5	2.8	2.1	3	$\Delta 2.32$

$\Delta$  4H5H  $\rightarrow$  4H6H = +0.02 mm

ID

ID

ID

ID

● 193833	● 170491	● 169767	● 170492
● 193834	● 193871	● 193908	● 193945
● 193835	● 193872	● 193909	● 193946
● 193836	● 193873	● 193910	● 193947
● 193837	● 193874	● 193911	● 193948
● 193838	● 193875	● 193912	● 193949
● 193839	● 193876	● 193913	● 193950
● 193840	● 193877	● 193914	● 193951



# TAZ

TAZ40



TAZ40VS



TAZ50



TAZ50VS

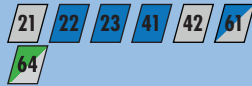

TAZ40

TAZ40VS

TAZ50

TAZ50VS

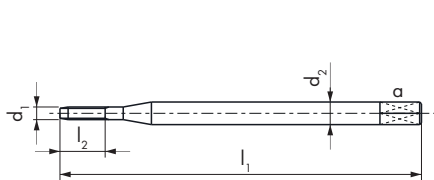

$\emptyset d_1$ SF	P mm	$l_1$ mm	$l_2$ mm	$d_2$ mm	a mm		
1.4	0.2	40	4.2	2.5		3	$\Delta 1.26$
1.6	0.2	40	4.8	2.5		3	$\Delta 1.46$
1.8	0.2	40	5.4	2.5		3	$\Delta 1.66$
2	0.2	45	6	2.8	2.1	3	$\Delta 1.86$
2.2	0.2	45	6.6	2.8	2.1	3	$\Delta 2.06$
2.2	0.25	45	6.6	2.8	2.1	3	$\Delta 2.02$
2.5	0.2	50	7.5	2.8	2.1	3	$\Delta 2.36$
2.5	0.25	50	7.5	2.8	2.1	3	$\Delta 2.32$

ID	ID	ID	ID
● 193986	● 194051	● 194111	● 194174
● 193987	● 194052	● 194112	● 194175
● 193988	● 194053	● 194113	● 194176
● 193989	● 194054	● 194114	● 194177
● 193990	● 194055	● 194115	● 194178
● 193991	● 194056	● 194116	● 194179
● 193992	● 194057	● 194117	● 194180
● 193993	● 194058	● 194118	● 194181

$\Delta$  4H5H → 4H6H = +0.02 mm

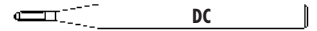

# CMS

CMS50



62 63 93

CMS50VS



31 62 63 73 74 83  
93

CMS50

CMS50VS

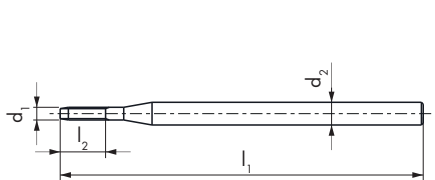

$\emptyset d_1$ SF	P mm	$l_1$ mm	$l_2$ mm	$d_2$ h5 mm		
1.4	0.2	32	5.2	2	3	$\Delta 1.26$
1.6	0.2	32	6	2	3	$\Delta 1.46$
1.8	0.2	32	6.7	2	3	$\Delta 1.66$
2	0.2	39	7.5	3	3	$\Delta 1.86$
2.2	0.2	39	8.2	3	3	$\Delta 2.06$
2.2	0.25	39	8.2	3	3	$\Delta 2.02$
2.5	0.2	39	9.3	3	3	$\Delta 2.36$
2.5	0.25	39	9.3	3	3	$\Delta 2.32$

$\Delta$  4H5H  $\rightarrow$  4H6H = +0.02 mm

ID

ID

● 180329	● 193694
● 193632	● 193695
● 193633	● 193696
● 193634	● 193697
● 193635	● 193698
● 193636	● 193699
● 193637	● 193700
● 193638	● 193701

## TAN

TAN40



62 63 91

TAN40VS



VS

11 12 13 14 32 62  
63 71 72 73 74 81  
93

TAN50



62 63 91

TAN50VS



VS

11 12 13 14 32 62  
63 71 72 73 74 81  
93

TAN40

TAN40VS

TAN50

TAN50VS

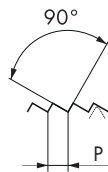
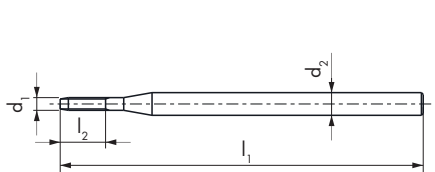

$\emptyset d_1$ SL	P mm	$l_1$ mm	$l_2$ mm	$d_2$ mm			ID	ID	ID	ID
0.5	0.1	25	1.5	2	3	0.46	● 600065	● 600073	● 600081	● 600089
0.6	0.125	25	1.8	2	3	0.55	● 600066	● 600074	● 600082	● 600090
0.7	0.15	25	2.1	2	3	0.64	● 600067	● 600075	● 600083	● 600091
0.8	0.15	25	2.4	2	3	0.74	● 600068	● 600076	● 600084	● 600092
0.9	0.175	25	2.7	2	3	0.83	● 600069	● 600077	● 600085	● 600093
1	0.2	40	3	2.5	3	0.92	● 600070	● 600078	● 600086	● 600094
1.2	0.2	40	3.6	2.5	3	1.12	● 600071	● 600079	● 600087	● 600095
1.4	0.25	40	4.2	2.5	3	1.3	● 600072	● 600080	● 600088	● 600096

# TAZ

TAZ40



TAZ40VS



VS



TAZ50



TAZ50VS



VS

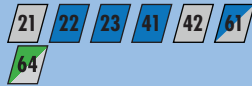

TAZ40

TAZ40VS

TAZ50

TAZ50VS

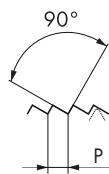
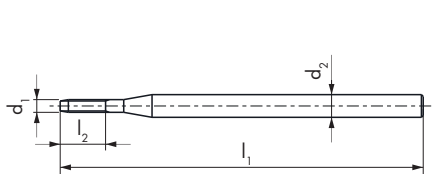

$\emptyset d_1$ SL	P mm	$l_1$ mm	$l_2$ mm	$d_2$ mm			ID	ID	ID	ID
0.5	0.1	25	1.5	2	3		● 600210	● 600218	● 600194	● 600202
0.6	0.125	25	1.8	2	3		● 600211	● 600219	● 600195	● 600203
0.7	0.15	25	2.1	2	3		● 600212	● 600220	● 600196	● 600204
0.8	0.15	25	2.4	2	3		● 600213	● 600221	● 600197	● 600205
0.9	0.175	25	2.7	2	3		● 600214	● 600222	● 600198	● 600206
1	0.2	40	3	2.5	3		● 600215	● 600223	● 600199	● 600207
1.2	0.2	40	3.6	2.5	3		● 600216	● 600224	● 600200	● 600208
1.4	0.25	40	4.2	2.5	3		● 600217	● 600225	● 600201	● 600209

nano

# CMS

CMS50



62 63 93

CMS50VS



31 62 63 73 74 83  
93

CMS50

CMS50VS

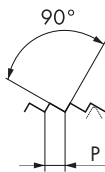
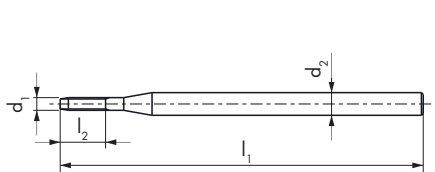

$\emptyset d_1$ SL	P mm	$l_1$ mm	$l_2$ mm	$d_2 h_5$ mm			ID	ID
0.3	0.06	32	1.1	1.5	3	0.27	● 600097	● 600226
0.35	0.06	32	1.3	1.5	3	0.32	● 600098	● 600227
0.4	0.08	32	1.5	1.5	3	0.36	● 600099	● 600228
0.5	0.1	32	1.8	1.5	3	0.46	● 600039	● 600229
0.6	0.125	32	2.2	1.5	3	0.55	● 600040	● 600230
0.7	0.15	32	2.6	1.5	3	0.64	● 600041	● 600231
0.8	0.15	32	3	1.5	3	0.74	● 600042	● 600232
0.9	0.175	32	3.3	1.5	3	0.83	● 600043	● 600233
1	0.2	32	3.7	2	3	0.92	● 600044	● 600234
1.2	0.2	32	4.5	2	3	1.12	● 600045	● 600235
1.4	0.25	32	5.2	2	3	1.3	● 600046	● 600236





# H | PERSEVERING THREADING

nanos



## GEWINDEFORMER NANO THREAD FORMERS NANO

**DC** -Anwendungsgruppen

**DC** Material classification

Werkstoff-Gruppen Material groups		Werkstoffbezeichnung	Material designation	Härte Hardness (HB)	Festigkeit Tensile strength Rm (N/mm <sup>2</sup> )	Dehnung Elongation A (%)
<b>10</b> Stahl Steels	11	Automatenstahl	Free-cutting steels	< 200	< 700	< 10
	12	Baustahl, Einsatzstahl	Structural, cementation steels	< 200	< 700	< 30
	13	Kohlenstoffstahl	Carbon steels	< 300	< 1000	< 20
	14	Stahl legiert < 850 N/mm <sup>2</sup>	Alloy steels < 850 N/mm <sup>2</sup>	< 250	< 850	< 30
	15	Stahl legiert / vergütet > 850 - < 1150 N/mm <sup>2</sup>	Alloy steels hard. / temp. > 850 - < 1150 N/mm <sup>2</sup>	> 250	> 850	< 30
	16	Hochfester Stahl ≤ 44 HRC	High tensile alloy steels ≤ 44 HRC	> 250	> 850	< 12
	17	Stahl vergütet > 44 - ≤ 54 HRC	Alloy steels tempered > 44 - ≤ 54 HRC	> 410	> 1400	< 2
	18	Stahl gehärtet > 54 - ≤ 63 HRC	Alloy steels hardened > 54 - ≤ 63 HRC	> 560	> 1980	< 2
<b>20</b> Rostfreier Stahl Stainless steels	21	Rostfreier Stahl, geschwefelt	Free machining stainless steels	< 250	< 850	< 25
	22	Austenitisch	Austenitic stainless steels	< 250	< 850	> 20
	23	Ferritisch, martensitisch < 850 N/mm <sup>2</sup>	Ferritic and martensitic < 850 N/mm <sup>2</sup>	< 250	< 850	> 20
	24	Ferritisch, martensitisch > 850 - < 1150 N/mm <sup>2</sup>	Ferritic and martensitic > 850 - < 1150 N/mm <sup>2</sup>	> 250	> 850	> 15
<b>30</b> Guss Cast iron	31	Grauguss	Cast iron	< 250	< 850	< 10
	32	Kugelgraphitguss, Temporguss	Spheroidal graphite + malleable cast iron	< 250	< 850	> 10
<b>40</b> Titan Titanium	41	Reintitan	Pure titanium	< 250	< 850	> 20
	42	Titanlegierung	Titanium alloys	> 250	> 850	< 20
<b>50</b> Nickel Nickel	51	Nickellegierung 1 ≤ 850 N/mm <sup>2</sup>	Nickel alloys 1 ≤ 850 N/mm <sup>2</sup>	< 250	< 850	> 25
	52	Nickellegierung 2 > 850 - ≤ 1150 N/mm <sup>2</sup>	Nickel alloys 2 > 850 - ≤ 1150 N/mm <sup>2</sup>	> 250	> 850	< 25
	53	Nickellegierung 3 > 1150 - ≤ 1600 N/mm <sup>2</sup>	Nickel alloys 3 > 1150 - ≤ 1600 N/mm <sup>2</sup>	> 340	> 1150	< 20
<b>60</b> Kupfer Copper	61	Reinkupfer (Elektrolytkupfer)	Pure copper (electrolytic copper)	< 120	< 400	> 12
	62	Messing, Bronze, Rotguss (kurzspanend)	Short chip brass, phosphor bronze, gun metal	< 200	< 700	< 12
	63	Messing (langspanend)	Long chip brass	< 200	< 700	> 12
	64	Messing bleifrei	Lead free brass	< 220	< 700	> 15
<b>70</b> Aluminium Magnesium Aluminium Magnesium	71	Al unlegiert	Al unalloyed	< 100	< 350	> 15
	72	Al legiert Si < 1.5 %	Al alloyed Si < 1.5 %	< 150	< 500	> 15
	73	Al legiert Si > 1.5 % - < 10 %	Al alloyed Si > 1.5 % - < 10 %	< 120	< 400	< 15
	74	Al legiert Si > 10 %, Mg-Legierungen	Al alloyed Si > 10 %, Mg-alloys	< 120	< 400	< 10
<b>80</b> Kunststoff Plastic compounds	81	Thermoplaste	Thermoplastics	-	-	-
	82	Duroplaste	Duroplastics	-	-	-
	83	Faserverstärkte Kunststoffe	Glass fibre reinforced plastics	-	-	-
<b>90</b> Edelmetalle Precious metals	91	Gelbgold	Yellow gold	-	-	-
	92	Rotgold	Red gold	-	-	-
	93	Weissgold	White gold	-	-	-
	94	Silber	Silver	-	-	-



# GEWINDEFORMER NANO – THREAD FORMERS NANO



<b>Ab Seite:</b> <b>From page:</b>
<b>M</b>
<b>MF</b>
<b>UNC</b>
<b>UNF</b>
<b>S</b>
<b>SF</b>
<b>SL</b>

FA		CFA	
Normale Werkstoffe Normal materials		Nichteisen-Metalle Non-ferrous materials	
363	363	370	370
364	364		
365	365	371	371
366	366	372	372
367	367	373	373
368	368		
369	369		
FA80VS	FA83VS	CFA80VS	CFA83VS

	Vc (m/min) Guide Line				
	Ø 0.3 - 1.4 mm	Ø 1.4 - 2.8 mm			
	Beschichtet Coated	Beschichtet Coated			
11	4 - 10	12 - 20			11
12	4 - 10	12 - 20			12
13	4 - 10	12 - 20			13
14	4 - 10	12 - 20			14
15	3 - 6	6 - 12			15
16					16
17					17
18					18
21	4 - 10	12 - 20			21
22	3 - 6	6 - 12			22
23	3 - 6	6 - 12			23
24	3 - 6	6 - 12			24
31					31
32					32
41					41
42					42
51	3 - 6	6 - 12			51
52					52
53					53
61	4 - 10	12 - 20			61
62	4 - 10	12 - 20			62
63	4 - 10	12 - 20			63
64	4 - 10	12 - 20			64
71	4 - 10	12 - 20			71
72	4 - 10	12 - 20			72
73	4 - 10	12 - 20			73
74					74
81					81
82					82
83					83
91	4 - 10	12 - 20			91
92	4 - 10	12 - 20			92
93	4 - 10	12 - 20			93
94	4 - 10	12 - 20			94

nano



				FA		CFA	
Merkmale Characteristics							
Lochart Hole type							
				FA80VS	FA83VS	CFA80VS	CFA83VS
M	4HX / 6HX	ISO DIN 14 ISO DIN 13	DC ~DIN 371	363	363	370	370
MF	4HX / 6HX	ISO DIN 13	DC ~DIN 371	364	364		
UNC	2BX	ASME B1.1	DC ~DIN 371	365	365	371	371
	3BX	ASME B1.1	DC ~DIN 371	365	365		
UNF	2BX	ASME B1.1	DC ~DIN 371	366	366	372	372
	3BX	ASME B1.1	DC ~DIN 371	366	366		
S	NIHS	NIHS 06 - 10	DC	367	367	373	373
SF	NIHS	NIHS 06-10 Fine Thread	DC	368	368		
SL	Safelock	SL 15 - 01	DC	369	369		

## FA

FA80VS



FA83VS



FA80VS

FA83VS

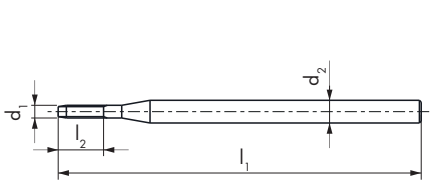

$\emptyset d_1$ M	P mm	$l_1$ mm	$l_2$ mm	$d_2$ mm		ID	ID
0.5	0.125	25	1.5	2	$\Delta 0.44$	● 161750	● 173719
0.6	0.15	25	1.8	2	$\Delta 0.53$	● 152412	● 173720
0.7	0.175	25	2.1	2	$\Delta 0.62$	● 152415	● 173721
0.8	0.2	25	2.4	2	$\Delta 0.71$	● 152418	● 173722
0.9	0.225	25	2.7	2	$\Delta 0.8$	● 152421	● 173723
1	0.25	40	3	2.5	$\Delta 0.88$	● 151559	● 173729
1.2	0.25	40	3.6	2.5	$\Delta 1.08$	● 151565	● 173730
1.4	0.3	40	4.2	2.5	$\Delta 1.25$	● 152429	● 173731

$\Delta$  Tol. = +0/0.02 mm

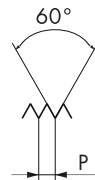
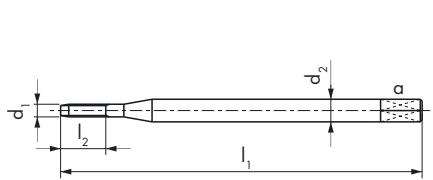

$\emptyset d_1$ M	P mm	$l_1$ mm	$l_2$ mm	$d_2$ mm	a mm		ID	ID
1.6	0.35	40	4.8	2.5		$\Delta 1.45$	● 152433	● 193801
1.8	0.35	40	5.4	2.5		$\Delta 1.65$	● 193764	● 193802
2	0.4	45	8	2.8	2.1	$\Delta 1.8$	● 151566	● 193803
2.3	0.4	45	9	2.8	2.1	$\Delta 2.1$	● 193765	● 193804
2.5	0.45	50	10	2.8	2.1	$\Delta 2.3$	● 193766	● 193805
2.6	0.45	50	10	2.8	2.1	$\Delta 2.4$	● 193767	● 193806

$\Delta$  Tol. = +0/0.02 mm



## FA

FA80VS



FA83VS



FA80VS

FA83VS

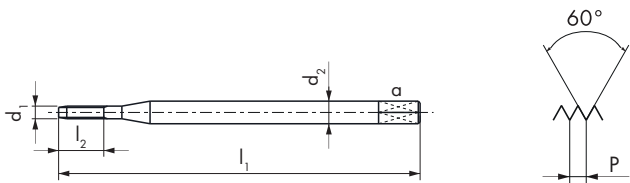

4HX

4HX

$\varnothing d_1$ MF	P mm	$l_1$ mm	$l_2$ mm	$d_2$ mm	a mm		ID	ID
1.4	0.2	40	4.2	2.5		$\Delta 1.31$	● 155928	● 180436
1.6	0.2	40	4.8	2.5		$\Delta 1.51$	● 156480	● 193807
1.8	0.2	40	5.4	2.5		$\Delta 1.71$	● 193768	● 193808
2	0.2	45	6	2.8	2.1	$\Delta 1.91$	● 193769	● 193809
2	0.25	45	6	2.8	2.1	$\Delta 1.88$	● 193770	● 193810
2.2	0.2	45	6.6	2.8	2.1	$\Delta 2.11$	● 193771	● 193811
2.2	0.25	45	6.6	2.8	2.1	$\Delta 2.08$	● 193772	● 193812
2.3	0.2	45	6.9	2.8	2.1	$\Delta 2.21$	● 193773	● 193813
2.3	0.25	45	6.9	2.8	2.1	$\Delta 2.18$	● 193774	● 193814
2.5	0.2	50	7.5	2.8	2.1	$\Delta 2.41$	● 193775	● 193815
2.5	0.25	50	7.5	2.8	2.1	$\Delta 2.38$	● 193776	● 193816

$\Delta$  Tol. = +0/0.02 mm

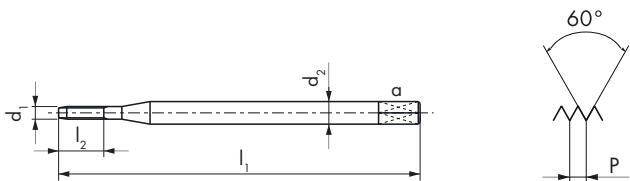

6HX

6HX

$\varnothing d_1$ MF	P mm	$l_1$ mm	$l_2$ mm	$d_2$ mm	a mm	$\Delta$	ID	ID
2.5	0.35	50	7.5	2.8	2.1	$\Delta 2.35$	● 193777	● 193817
2.6	0.35	50	7.8	2.8	2.1	$\Delta 2.45$	● 193778	● 193818

$\Delta$  Tol. = +0/0.02 mm



PM

DC - DIN 371

## FA

FA80VS  VS

FA83VS  VS

11	12	13	14	15
21	22	23	24	51
61	63	64	71	72
73	91	92	94	

FA80VS

FA83VS

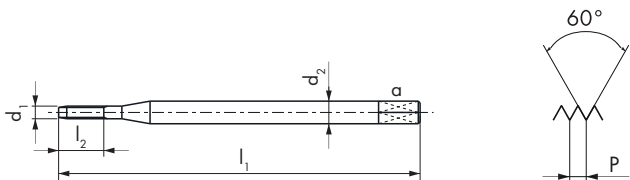

2BX

2BX

$\emptyset d_1$ UNC	P TPI	$d_1$ mm	$l_1$ mm	$l_2$ mm	$d_2$ mm	$a$ mm	
1	64	1.85	40	5.6	2.5	2.1	$\Delta 1.65$
2	56	2.18	45	9	2.8	2.1	$\Delta 2$
3	48	2.51	50	10	2.8	2.1	$\Delta 2.25$

ID

ID

- |          |          |
|----------|----------|
| ● 193779 | ● 193819 |
| ● 193780 | ● 193820 |
| ● 193781 | ● 193821 |

Tol. = +0/0.02 mm

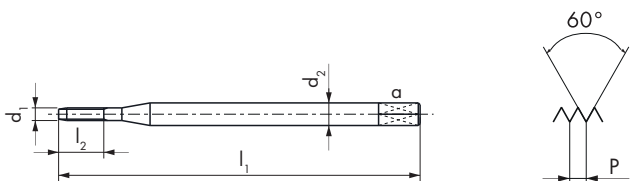

3BX

3BX

$\emptyset d_1$ UNC	P TPI	$d_1$ mm	$l_1$ mm	$l_2$ mm	$d_2$ mm	$a$ mm	
1	64	1.85	40	5.6	2.5	2.1	$\Delta 1.65$
2	56	2.18	45	9	2.8	2.1	$\Delta 2$
3	48	2.51	50	10	2.8	2.1	$\Delta 2.25$

ID

ID

- |          |          |
|----------|----------|
| ● 193782 | ● 193822 |
| ● 193783 | ● 193823 |
| ● 193784 | ● 193824 |

Tol. = +0/0.02 mm

nomo



PM

DC - DIN 371

## FA

FA80VS  VS

FA83VS  VS

11	12	13	14	15
21	22	23	24	51
61	63	64	71	72
73	91	92	94	

FA80VS

FA83VS

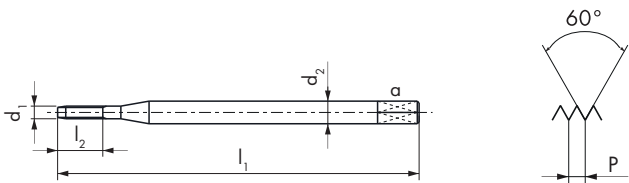

2BX

2BX

$\emptyset d_1$ UNF	P TPI	$d_1$ mm	$l_1$ mm	$l_2$ mm	$d_2$ mm	$a$ mm	
0	80	1.52	40	4.6	2.5	$\Delta 1.4$	
1	72	1.85	40	5.6	2.5	$\Delta 1.7$	
2	64	2.18	45	9	2.8	2.1	$\Delta 2$
3	56	2.51	50	10	2.8	2.1	$\Delta 2.3$

$\Delta$  Tol. = +0/0.02 mm

ID

ID

- |  |  |
|--|--|
| <span style="color: green;">●</span> 193785  | <span style="color: green;">●</span> 193825  |
| <span style="color: green;">●</span> 193786  | <span style="color: green;">●</span> 193826  |
| <span style="color: green;">●</span> 193787  | <span style="color: green;">●</span> 193827  |
| <span style="color: orange;">●</span> 193788 | <span style="color: orange;">●</span> 193828 |

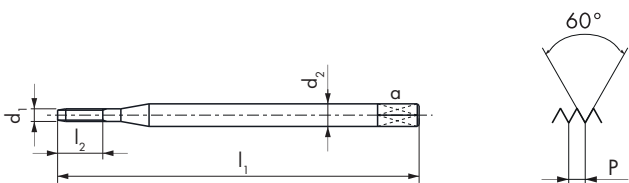

3BX

3BX

$\emptyset d_1$ UNF	P TPI	$d_1$ mm	$l_1$ mm	$l_2$ mm	$d_2$ mm	$a$ mm	
0	80	1.52	40	4.6	2.5	$\Delta 1.4$	
1	72	1.85	40	5.6	2.5	$\Delta 1.7$	
2	64	2.18	45	9	2.8	2.1	$\Delta 2$
3	56	2.51	50	10	2.8	2.1	$\Delta 2.3$

$\Delta$  Tol. = +0/0.02 mm

ID

ID

- |  |  |
|--|--|
| <span style="color: green;">●</span> 193789  | <span style="color: green;">●</span> 193829  |
| <span style="color: green;">●</span> 193790  | <span style="color: green;">●</span> 193830  |
| <span style="color: green;">●</span> 193791  | <span style="color: green;">●</span> 193831  |
| <span style="color: orange;">●</span> 193792 | <span style="color: orange;">●</span> 193832 |



PM

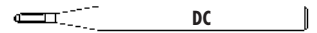

## FA

FA80VS VS

FA83VS VS

11	12	13	14	15
21	22	23	24	51
61	63	64	71	72
73	91	92	94	

FA80VS

FA83VS

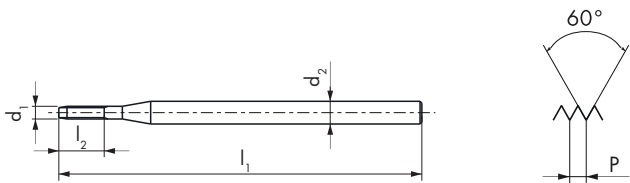

$\varnothing d_1$ S	P mm	$l_1$ mm	$l_2$ mm	$d_2$ mm	
0.5	0.125	25	1.5	2	$\Delta 0.44$
0.6	0.15	25	1.8	2	$\Delta 0.53$
0.7	0.175	25	2.1	2	$\Delta 0.62$
0.8	0.2	25	2.4	2	$\Delta 0.71$
0.9	0.225	25	2.7	2	$\Delta 0.8$
1	0.25	40	3.0	2.5	$\Delta 0.88$
1.2	0.25	40	3.6	2.5	$\Delta 1.08$
1.4	0.3	40	4.2	2.5	$\Delta 1.25$

ID

ID

● 158977	● 173724
● 151561	● 173725
● 151742	● 173726
● 151564	● 173727
● 151562	● 173728
● 151542	● 173732
● 151543	● 173733
● 152427	● 173734

$\Delta$  Tol. = +0/0.02 mm



# FA

FA80VS



VS

FA83VS



VS



FA80VS

FA83VS

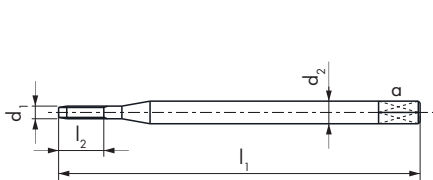

Ø d <sub>1</sub> SF	P mm	l <sub>1</sub> mm	l <sub>2</sub> mm	d <sub>2</sub> mm	a mm	
1.4	0.2	40	4.2	2.5		△ 1.31
1.6	0.2	40	4.8	2.5		△ 1.51
1.8	0.2	40	5.4	2.5		△ 1.71
2	0.2	45	6	2.8	2.1	△ 1.91
2.2	0.2	45	6.6	2.8	2.1	△ 2.11
2.2	0.25	45	6.6	2.8	2.1	△ 2.08
2.5	0.2	50	7.5	2.8	2.1	△ 2.41
2.5	0.25	50	7.5	2.8	2.1	△ 2.38

ID	ID
● 176180	● 193793
● 193757	● 193794
● 193758	● 193795
● 193759	● 193796
● 193760	● 193797
● 193761	● 193798
● 193762	● 193799
● 193763	● 193800

△ Tol. = +0/0.02 mm



## FA

FA80VS



VS

FA83VS



VS



FA80VS

FA83VS

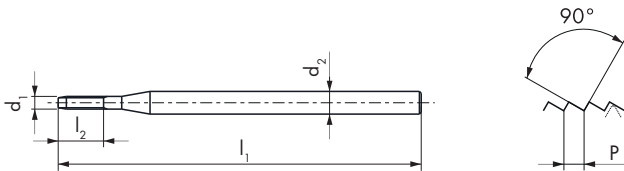

$\varnothing d_1$ SL	P mm	$l_1$ mm	$l_2$ mm	$d_2$ mm	ID	ID
0.5	0.1	25	1.5	2	● 600049	● 600100
0.6	0.125	25	1.8	2	● 600050	● 600101
0.7	0.15	25	2.1	2	● 600051	● 600102
0.8	0.15	25	2.4	2	● 600052	● 600103
0.9	0.175	25	2.7	2	● 600053	● 600104
1	0.2	40	3	2.5	● 600054	● 600105
1.2	0.2	40	3.6	2.5	● 600055	● 600106
1.4	0.25	40	4.2	2.5	● 600056	● 600107

## CFA

CFA80VS



62 63 91 92 94

CFA83VS



CFA80VS

CFA83VS



4HX

4HX

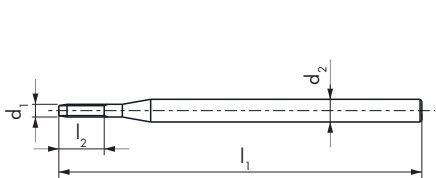

$\emptyset d_1$ M	P mm	$l_1$ mm	$l_2$ mm	$d_2$ h5 mm	
0.5	0.125	32	1.5	1.5	$\Delta 0.44$
0.6	0.15	32	1.8	1.5	$\Delta 0.53$
0.7	0.175	32	2.1	1.5	$\Delta 0.62$
0.8	0.2	32	2.4	1.5	$\Delta 0.71$
0.9	0.225	32	2.7	1.5	$\Delta 0.8$
1	0.25	32	3	2	$\Delta 0.88$
1.2	0.25	32	3.6	2	$\Delta 1.08$
1.4	0.3	32	4.2	2	$\Delta 1.25$

Tol. = +0/0.02 mm

ID

ID

● 171771	● 193611
● 171773	● 193612
● 171775	● 193613
● 171777	● 193614
● 171779	● 193615
● 171782	● 193616
● 171783	● 193617
● 171785	● 193618

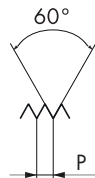
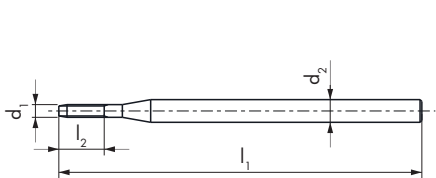

$\emptyset d_1$ M	P mm	$l_1$ mm	$l_2$ mm	$d_2$ h5 mm	
1.6	0.35	32	4.8	2	$\Delta 1.45$
1.8	0.35	32	5.4	2	$\Delta 1.65$
2	0.4	39	8	3	$\Delta 1.8$
2.3	0.4	39	9	3	$\Delta 2.1$
2.5	0.45	39	10	3	$\Delta 2.3$
2.6	0.45	39	10	3	$\Delta 2.4$

Tol. = +0/0.02 mm

6HX

6HX

ID

ID

● 193590	● 193619
● 193591	● 193620
● 193592	● 193621
● 193593	● 193622
● 193594	● 193623
● 193595	● 193624

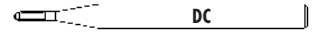

## CFA

CFA80VS



62 63 91 92 94

CFA83VS



CFA80VS

CFA83VS

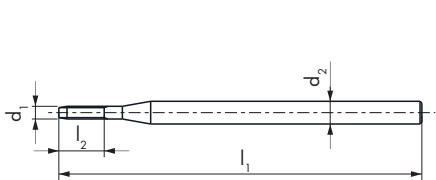

$\emptyset d$ UNC	P TPI	$d_1$ mm	$l_1$ mm	$l_2$ mm	$d_2$ h5 mm	
1	64	1.85	32	5.5	2	$\Delta 1.65$
2	56	2.18	39	8.6	3	$\Delta 2$
3	48	2.51	39	10	3	$\Delta 2.25$

ID

ID

● 193596	● 193625
● 193597	● 193626
● 193598	● 193627

$\Delta$  Tol. = +0/0.02 mm

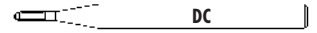

## CFA

CFA80VS



62 63 91 92 94

CFA83VS



CFA80VS

CFA83VS



2BX

2BX

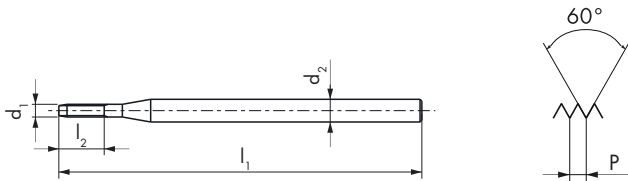

$\emptyset d$ UNF	P TPI	$d_1$ mm	$l_1$ mm	$l_2$ mm	$d_2$ h5 mm	
0	80	1.52	32	4.5	2	$\Delta 1.4$
1	72	1.85	32	5.5	2	$\Delta 1.7$
2	64	2.18	39	8.6	3	$\Delta 2$
3	56	2.51	39	10	3	$\Delta 2.3$

ID	ID
● 193599	● 193628
● 193600	● 193629
● 193601	● 193630
● 193602	● 193631

$\Delta$  Tol. = +0/0.02 mm



VHM  
CAR

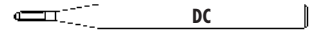

## CFA

CFA80VS



62 63 91 92 94

CFA83VS



CFA80VS

CFA83VS

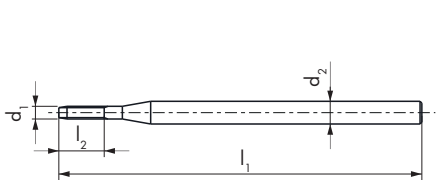

$\varnothing d_1$ S	P mm	$l_1$ mm	$l_2$ mm	$d_2$ h5 mm	
0.5	0.125	32	1.5	1.5	$\Delta 0.44$
0.6	0.15	32	1.8	1.5	$\Delta 0.53$
0.7	0.175	32	2.1	1.5	$\Delta 0.62$
0.8	0.2	32	2.4	1.5	$\Delta 0.71$
0.9	0.225	32	2.7	1.5	$\Delta 0.8$
1	0.25	32	3	2	$\Delta 0.88$
1.2	0.25	32	3.6	2	$\Delta 1.08$
1.4	0.3	32	4.2	2	$\Delta 1.25$

$\Delta$  Tol. = +0/0.02 mm

ID

ID

● 171770	● 193603
● 171772	● 193604
● 171774	● 193605
● 171776	● 193606
● 171778	● 193607
● 171780	● 193608
● 171781	● 193609
● 171784	● 193610

## GEWINDELEHRDORNE – THREAD PLUG GAUGES



### MESSTECHNIK – METROLOGY



### PRODUKTION – PRODUCTION



< 2.74 mm



#### EINSATZ

Der erste unvollständige Gewindegang und die Frontfläche der Lehre sind hochpräzise und passgenau geschliffen – eine entscheidende Voraussetzung für korrekte Messergebnisse und die Überprüfung der Gewinde auf einer grösstmöglichen Länge.



#### PROFILKONTROLLE

Dank unserer Kompetenz auf dem Gebiet des Schleifens können wir die perfekte Einhaltung der Toleranzen des Gewindeprofils und eine einwandfreie Oberflächenqualität gewährleisten.



#### NO-GO-GEWINDELEHRRING

Unsere NO-GO-Lehrringe gewährleisten eine exakte Kontrolle der Gewindeflanken von Schrauben: ihr freigestochener Aussendurchmesser verhindert Fehlmessungen durch blockierende Schrauben am Aussendurchmesser während des Prüfungsvorgangs.



#### MODULARES SYSTEM

Bei Bedarf kann die GO-Gewindelehre mit einem Verbindungsstück mit der NO-GO-Lehre zusammengeschraubt werden. In ihrer stabilen Verpackung lassen sich die Lehren sicher transportieren. Der mit Aussparungen versehene Schaumstoffeinsatz schützt die Werkzeuge vor Beschädigungen und Schmutz.

# PRÜF-GEWINDELEHRDORNE — PLUG CHECK GAUGES

Der **NO-GO**-Prüf-Gewindelehrdorn dient zur Kontrolle des neuwertigen Lehrings.

The **NO-GO** plug check gauge is the foolproofing device for the new ring gauge.

Mit dem **GO**-Prüf-Gewindelehrdorn überprüfen Sie die Qualität Ihres Lehrings.

The **GO** plug check gauge is used to check the quality of your ring gauge.

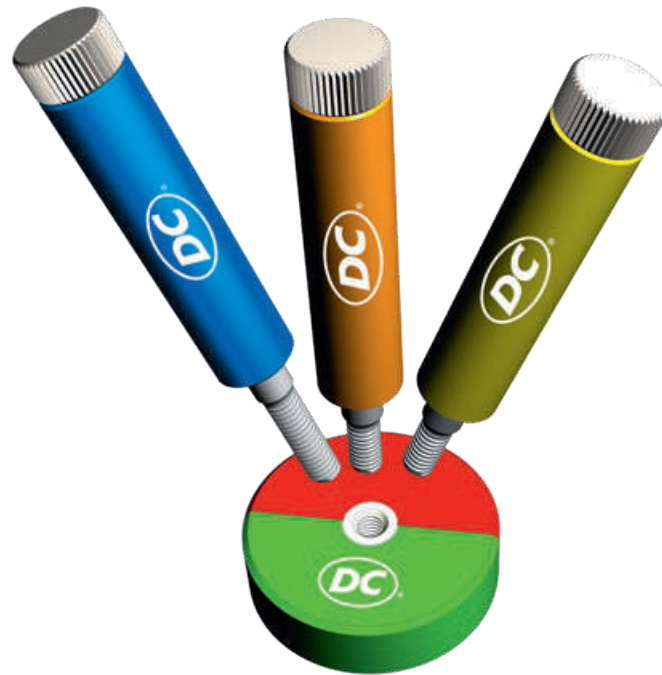

Der Verschleisslehrdorn **WEAR** verlängert die Lebensdauer Ihres Lehrings bis zu einem festgelegten Schwellenwert.

The master plug gauge **WEAR** will extend the service life of your ring gauge up to a certain tolerance limit.

## UTILISATION

The fact that the initial turn of the screw thread and also the tip of the gauge have been ground flat ensures that the tool engages optimally in the thread, which is essential for ensuring a correct measurement. This enables the gauge to check the thread at its maximum depth.

## PROFILE CONTROL

Our expertise in the field of rectification ensures we have perfect control of tolerances for the shape of the profile and for surface textures.

## NO-GO RING GAUGE

The cut-away on the exterior diameter of our NO-GO ring gauges ensures the sides of the screw can be optimally checked, eliminating the risk of any incorrect inspection caused by a blockage on the exterior diameter of the gauge.

## MODULAR SYSTEM

A coupling screw enables the GO gauge to be connected to the NO-GO section as required. The rigid box protects the gauges during transportation. Its moulded interior keeps the product clean and protects it from impacts.

# DAS SCS-ZERTIFIKAT



Ein Zertifikat ist ein schriftlicher Nachweis über die Qualität der im Unternehmen eingesetzten Messinstrumente. DC NANO TOOLS SA (Akkreditierung SCS 0143), ein Mitglied der DC SWISS Holding, bietet Ihnen die Prüfung und Kalibrierung Ihrer Gewindelehren nach der internationalen Norm ISO 17025 an. Diese kostenpflichtige Dienstleistung wird für Flankendurchmesser von 0.1 bis 3.0 mm und für Aussendurchmesser von 0.1 bis 3.5 mm angeboten.

Alle Lehrdorne sind SCS-zertifiziert.

ISO 17025:2017 akkreditiert © DC NANO TOOLS SA

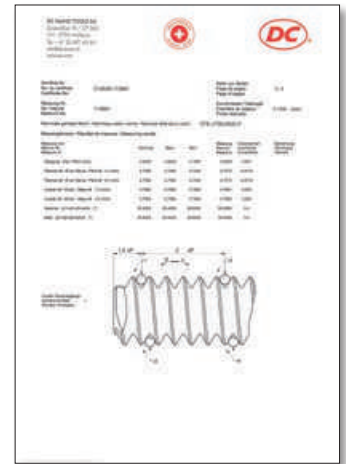

# SCS MEASUREMENT CERTIFICATE



A certificate is written confirmation of the quality of a company's metrological equipment. DC NANO TOOLS SA (SCS accreditation 0143), a member of the DC SWISS Group, can inspect and calibrate thread gauges for you in accordance with the ISO 17025 international standard. This chargeable service is available for pitch diameters of 0.1 to 3.0 mm and external diameters of 0.1 to 3.5 mm.

All plug thread gauges are SCS certified.

ISO 17025:2017 accredited © DC NANO TOOLS SA

# SO ERHALTEN SIE IHR KONFORMITÄTZERTIFIKAT ONLINE

Ab sofort können Sie Ihr Konformitätszertifikat von überall direkt per Smartphone anfordern. Dazu scannen Sie einfach den QR-Code auf der Karte, die der Box beiliegt und laden die PDF-Datei im Anhang herunter.

Der mit jeder Box gelieferte Konformitätsnachweis bestätigt, dass am Ende der Fertigung eine sorgfältige Kontrolle durchgeführt wurde.

Qualitätskontrolle DC SWISS SA

# DOWNLOAD YOUR CONFIRMATION OF COMPLIANCE

You can now access your confirmation of compliance any time, at any place on your phone. Simply scan the QR code on the card inside the box and download the associated pdf file.

The confirmation of compliance accompanying each box confirms that the factory has scrupulously followed the post-production monitoring process.

DC SWISS SA quality control

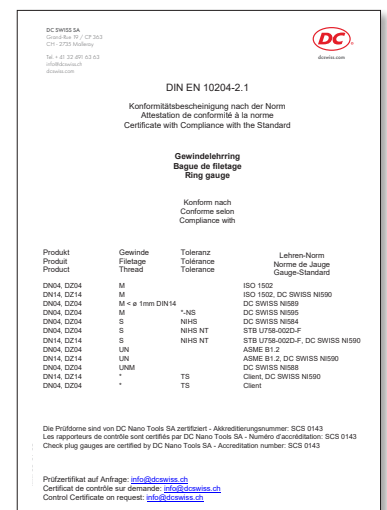
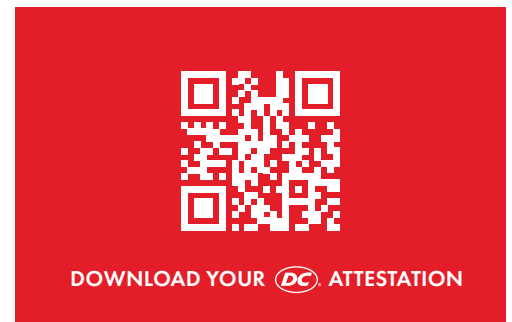





DC

## VERFÜGBARE SETS — AVAILABLE SETS



**GEWINDELEHRDORNE DN / GEWINDELEHRRINGE DN  
THREAD PLUG GAUGES & RING GAUGES DN**

**EINHEITS-SET — SINGLE SET**



**GEWINDELEHRRINGE DZ  
THREAD RING GAUGES DZ**

**EINHEITS-SET — SINGLE SET**



**GEWINDELEHRDORNE DN / GEWINDELEHRRINGE DN  
PLUG GAUGES DN / RING GAUGES DN**

**10- ODER 20-TEILIGES SET  
SET OF 10 OR 20 ITEMS**

*Für jedes Set können Sie die gewünschte Anzahl  
GO / NO-GO-Gewindelehren bestimmen.*

*Wenden Sie sich gerne an uns wenn Sie  
eine andere Zusammenstellung wünschen.*

*You can select the exact number of  
GO / NO-GO thread gauges for each set.*

*Contact us for any other set compositions.*

[dcswiss.com](http://dcswiss.com) / [info@dcswiss.ch](mailto:info@dcswiss.ch) / +41 32 491 63 63

# BESTELLUNG NANO-GEWINDELEHREN – NANO THREAD GAUGES ORDER

## WERKZEUGTYP – TOOL TYPE

## MERKMALE – CHARACTERISTICS

ABMESSUNG DIMENSION	TOLERANZ TOLERANCE	NORM NORM	MENGE QUANTITY	SPEZIELLES SPECIFICS

## BEMERKUNGEN – REMARKS

---

## LIEFERINFORMATIONEN – DELIVERY INFORMATION



---

Bitte visieren Sie Ihre Bestellung.  
Thank you for initialing your order.





	Gewindelehrdorne Thread plug gauges			Gewindelehrringe Thread ring gauges				Prüf-Gewindelehrdorne Plug check gauges			
Merkmale Characteristics											
Typ Type	DN01 GO	DN01 GO	DN02 NO-GO	DZ04 GO	DZ14 NO-GO	DN04 GO	DN14 NO-GO	RN05-1 GO	RN15-1 GO	RN05-2 NO-GO	RN15-2 NO-GO
M 4H / 5h	ISO DIN 14										
	ISO DIN 13										
M 6H / 6g	ISO DIN 13										
M 5H / 6h	ISO DIN 13										
MF 4H / 4h	ISO DIN 13										
MF 6H / 6g	ISO DIN 13										
MF 6h	ISO DIN 13										
UNC 2B / 2A	ASME B1.1										
UNC 3B / 3A	ASME B1.1										
UNF 2B / 2A	ASME B1.1										
UNF 3B / 3A	ASME B1.1										
S NIHS 3G	NIHS										
S NIHS 4H	NIHS										
S NIHS 4H / 3G	NIHS										
S NIHS	NIHS										
S NIHS NT	NIHS										
SF NIHS 3G	NIHS										
SF NIHS 4H	NIHS										
SF NIHS 4H / 3G	NIHS										
SF NIHS	NIHS										
SF NIHS NT	NIHS										
SL	SL 15-01										

	Abnutzungsprüfdorne Master plug gauges WEAR	Kalibrier-Gewindelehndorne Calibration thread plug gauges
<b>Merkmale</b> Characteristics		
		
<b>Typ</b> Type	<b>RN05-3</b> <b>WEAR</b>	<b>RN15-3</b> <b>WEAR</b>
<b>M 4H / 5h</b> ISO DIN 14 ISO DIN 13		<b>EN00</b>
<b>M 6H / 6g</b> ISO DIN 14 ISO DIN 13	401	401
<b>M 5H / 6h</b> ISO DIN 13	401	401
<b>MF 4H / 4h</b> ISO DIN 13	404	404
<b>MF 6H / 6g</b> ISO DIN 13	404	404
<b>MF 6h</b> ISO DIN 13	404	404
<b>S NIHS</b> NIHS		411

**Piktogramme - Pictographs**

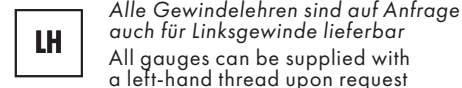
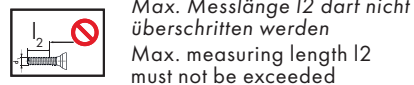
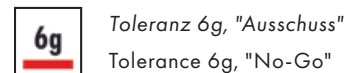
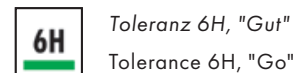

**Einsatz — Use**

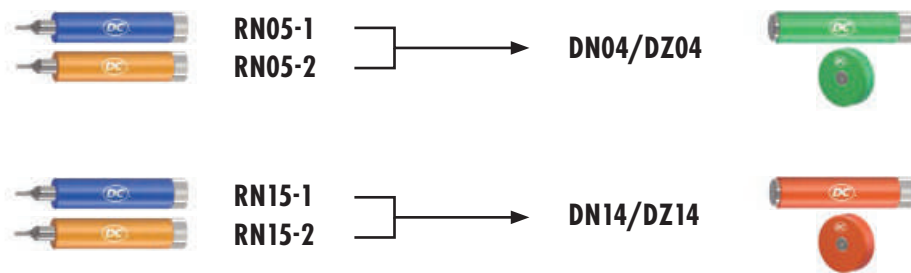

**nano**

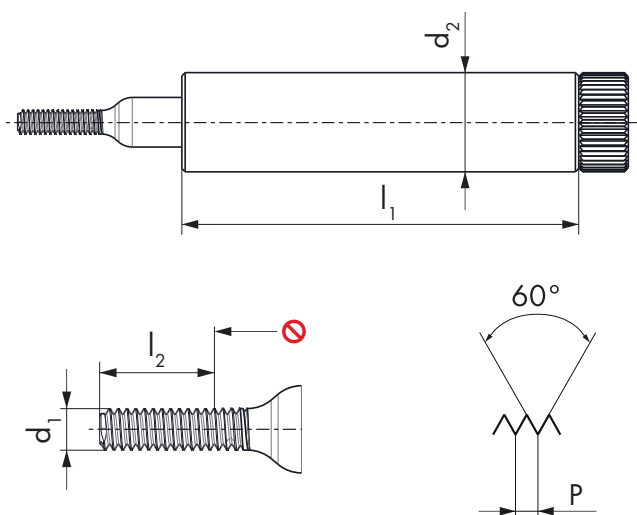

DN01 GO    DN02 NO-GO    DN01 GO    DN02 NO-GO



**4H**    **4H**    **5H**    **5H**

$\emptyset d_1$ M	P mm	$l_1$ mm	$l_2$ GO mm	$d_2$ mm	ID	ID	ID	ID
0.3	0.08	24	0.9	6	● 192778	● 192786		
0.35	0.09	24	1.05	6	● 192779	● 192787		
0.4	0.1	24	1.2	6	● 192780	● 192788		
0.5	0.125	24	1.5	6	● 192781	● 192789		
0.6	0.15	24	1.8	6	● 192782	● 192790		
0.7	0.175	24	2.1	6	● 192783	● 192791		
0.8	0.2	24	2.4	6	● 192784	● 192792		
0.9	0.225	24	2.7	6	● 192785	● 192793		
1	0.25	24	3	6	● 191113	● 191127	● 191421	● 191424
1.2	0.25	24	3.6	6	● 191114	● 191128	● 191422	● 191425
1.4	0.3	24	4.2	6	● 191115	● 191129	● 191423	● 191426

**6H**    **6H**

$\emptyset d_1$ M	P mm	$l_1$ mm	$l_2$ GO mm	$d_2$ mm	ID	ID
1.6	0.35	24	4.5	6	● 191427	● 191433
1.8	0.35	24	4.5	6	● 191428	● 191434
2	0.4	24	4.5	6	● 191429	● 191435
2.3	0.4	24	4.5	6	● 191430	● 191436
2.5	0.45	24	4.5	6	● 191431	● 191437
2.6	0.45	24	4.5	6	● 191432	● 191438



All nano thread plug gauges are SCS-certified and the paid certificate is available on request.



nano

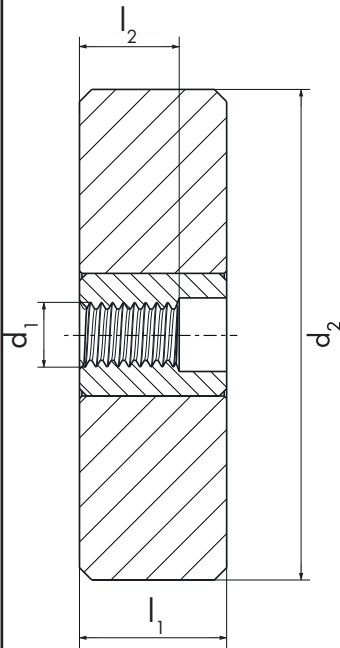

DZ04 GO

DZ14 NO-GO

DZ04 GO

DZ14 NO-GO



5h

5h

6h

6h

$\emptyset d_1$ M	P mm	$l_1$ mm	$l_2$ GO mm	$d_2$ mm	ID	ID	ID	ID
* 0.3	0.08	6	0.45	20	● 192842	● 192850		
* 0.35	0.09	6	0.53	20	● 192843	● 192851		
0.4	0.1	6	0.6	20	● 192844	● 192852		
0.5	0.125	6	0.75	20	● 192845	● 192853		
0.6	0.15	6	0.9	20	● 192846	● 192854		
0.7	0.175	6	1.05	20	● 192847	● 192855		
0.8	0.2	6	1.2	20	● 192848	● 192856		
0.9	0.225	6	1.35	20	● 192849	● 192857		
1	0.25	6	1.5	20			● 191473	● 191476
1.2	0.25	6	1.8	20			● 191474	● 191477
1.4	0.3	6	2.1	20			● 191475	● 191478
* In development								

6g

6g

$\emptyset d_1$ M	P mm	$l_1$ mm	$l_2$ GO mm	$d_2$ mm	ID	ID
1.6	0.35	6	2.4	20	● 191479	● 191485
1.8	0.35	6	2.7	20	● 191480	● 191486
2	0.4	6	3	20	● 191481	● 191487
2.3	0.4	6	3.45	20	● 191482	● 191488
2.5	0.45	6	3.75	20	● 191483	● 191489
2.6	0.45	6	3.9	20	● 191484	● 191490



All nano ring gauges have a certificate of measurement, established with SCS certified plug check gauges. The paid certificate is available on request.



nano

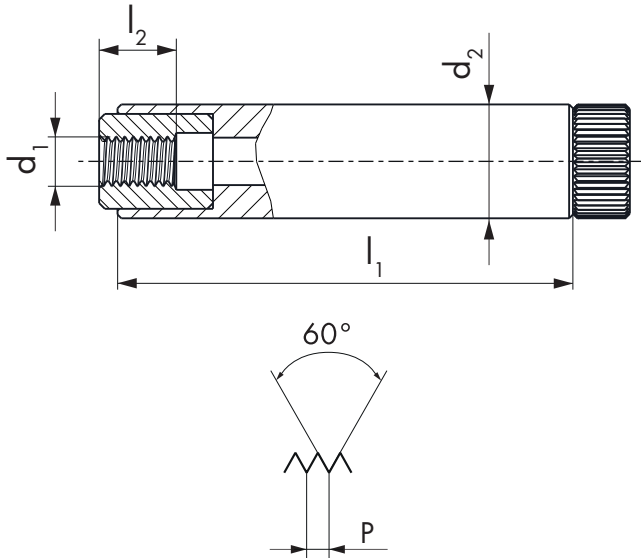

DN04 GO    DN14 NO-GO    DN04 GO    DN14 NO-GO



$\emptyset d_1$ M	P mm	$l_1$ mm	$l_2$ GO mm	$d_2$ mm	ID	ID	ID	ID
* 0.3	0.08	24	0.45	6	● 192800	● 192808		
* 0.35	0.09	24	0.53	6	● 192801	● 192809		
0.4	0.1	24	0.6	6	● 192802	● 192810		
0.5	0.125	24	0.75	6	● 192803	● 192811		
0.6	0.15	24	0.9	6	● 192804	● 192812		
0.7	0.175	24	1.05	6	● 192805	● 192813		
0.8	0.2	24	1.2	6	● 192806	● 192814		
0.9	0.225	24	1.35	6	● 192807	● 192815		
1	0.25	24	1.5	6			● 191447	● 191450
1.2	0.25	24	1.8	6			● 191448	● 191451
1.4	0.3	24	2.1	6			● 191449	● 191452
* In development								



$\emptyset d_1$ M	P mm	$l_1$ mm	$l_2$ GO mm	$d_2$ mm	ID	ID
1.6	0.35	24	2.4	6	● 191453	● 191459
1.8	0.35	24	2.7	6	● 191454	● 191460
2	0.4	24	3	6	● 191455	● 191461
2.3	0.4	24	3.45	6	● 191456	● 191462
2.5	0.45	24	3.75	6	● 191457	● 191463
2.6	0.45	24	3.9	6	● 191458	● 191464



All nano ring gauges have a certificate of measurement, established with SCS certified plug check gauges. The paid certificate is available on request.



**nano**

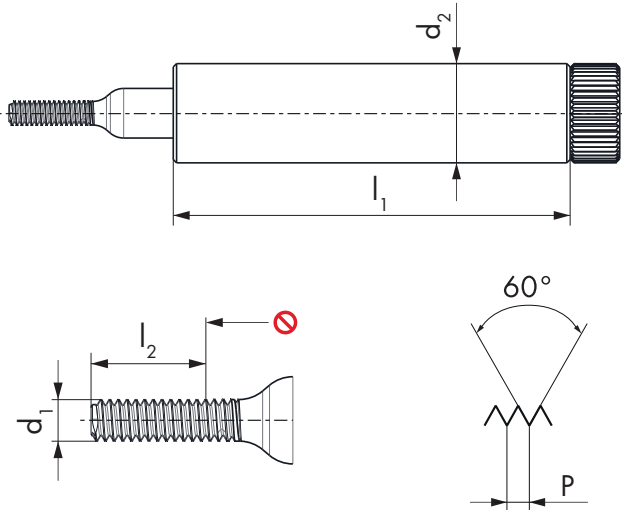

DN01 GO    DN02 NO-GO    DN01 GO    DN02 NO-GO



**4H**    **4H**    **6H**    **6H**

Ø d <sub>1</sub> MF	P mm	l <sub>1</sub> mm	l <sub>2</sub> GO mm	d <sub>2</sub> mm	ID	ID	ID	ID
1.4	0.2	24	4.2	6	● 191116	● 191130		
1.6	0.2	24	3	6	● 191117	● 191131		
1.8	0.2	24	3	6	● 191118	● 191132		
2	0.2	24	3	6	● 191119	● 191133		
2	0.25	24	3	6	● 192794	● 192797		
2.2	0.2	24	3	6	● 191120	● 191134		
2.2	0.25	24	3	6	● 191121	● 191135		
2.3	0.2	24	3	6	● 191122	● 191136		
2.3	0.25	24	3	6	● 191123	● 191137		
2.5	0.2	24	3	6	● 191124	● 191138		
2.5	0.25	24	3	6	● 191125	● 191139		
2.5	0.35	24	4.5	6			● 192795	● 192798
2.6	0.35	24	4.5	6			● 192796	● 192799

nano



All nano thread plug gauges are SCS-certified and the paid certificate is available on request.

## nano

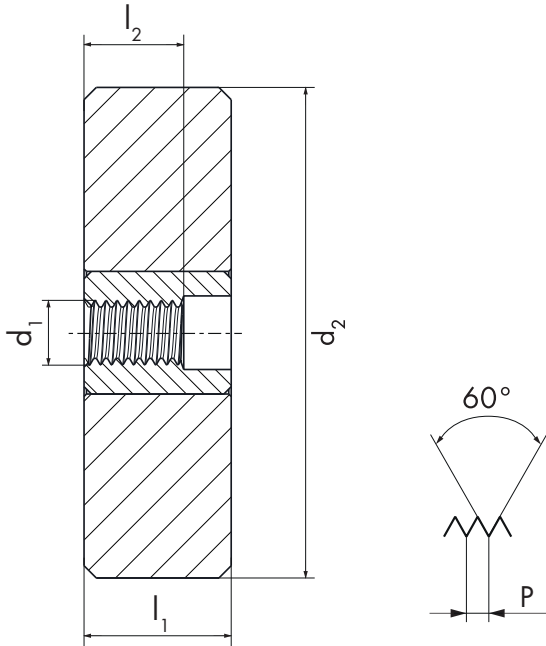

DZ04 GO

DZ14 NO-GO

DZ04 GO

DZ14 NO-GO



4h

4h

6g

6g

$\emptyset d_1$ MF	P mm	$l_1$ mm	$l_2$ GO mm	$d_2$ mm	ID	ID	ID	ID
1.4	0.2	6	2.1	20	● 194887	● 194888	● 192858 <sup>1</sup>	● 192871 <sup>1</sup>
1.6	0.2	6	1.8	20	● 191201	● 191215	● 191229	● 191243
1.8	0.2	6	1.8	20	● 191202	● 191216	● 191230	● 191244
2	0.2	6	1.8	20	● 190711	● 190710	● 191231	● 191245
2	0.25	6	2.25	20	● 194872	● 190690	● 194876	● 194877
2.2	0.2	6	1.8	20	● 191204	● 191218	● 191232	● 191246
2.2	0.25	6	2.25	20	● 191205	● 191219	● 191233	● 191247
2.3	0.2	6	1.8	20	● 191206	● 191220	● 191234	● 191248
2.3	0.25	6	2.25	20	● 191207	● 191221	● 191235	● 191249
2.5	0.2	6	1.8	20	● 191208	● 191222	● 191236	● 191250
2.5	0.25	6	2.25	20	● 194873	● 191223	● 191237	● 191251
2.5	0.35	6	3.75	20			● 192869	● 192882
2.6	0.35	6	3.9	20			● 192870	● 192883

<sup>1</sup> Tol. 6h



All nano ring gauges have a certificate of measurement, established with SCS certified plug check gauges. The paid certificate is available on request.

## nano

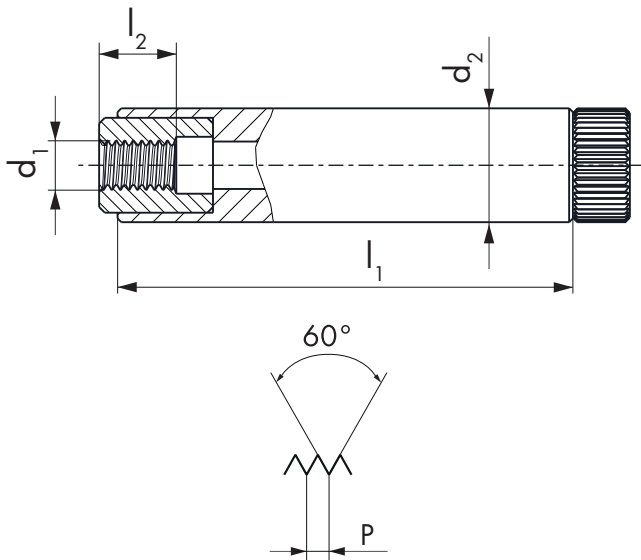

DN04 GO

DN14 NO-GO

DN04 GO

DN14 NO-GO



4h

4h

6g

6g

Ø d <sub>1</sub> MF	P mm	l <sub>1</sub> mm	l <sub>2</sub> GO mm	d <sub>2</sub> mm	ID	ID	ID	ID
1.4	0.2	24	2.1	6	● 194885	● 194886	● 192816 <sup>1</sup>	● 192829 <sup>1</sup>
1.6	0.2	24	1.8	6	● 191145	● 191159	● 191173	● 191187
1.8	0.2	24	1.8	6	● 191146	● 191160	● 191174	● 191188
2	0.2	24	1.8	6	● 191147	● 191161	● 191175	● 191189
2	0.25	24	2.25	6	● 194870	● 194871	● 194874	● 194875
2.2	0.2	24	1.8	6	● 191148	● 191162	● 191176	● 191190
2.2	0.25	24	2.25	6	● 191149	● 191163	● 191177	● 191191
2.3	0.2	24	1.8	6	● 191150	● 191164	● 191178	● 191192
2.3	0.25	24	2.25	6	● 191151	● 191165	● 191179	● 191193
2.5	0.2	24	1.8	6	● 191152	● 191166	● 191180	● 191194
2.5	0.25	24	2.25	6	● 191153	● 191167	● 191181	● 191195
2.5	0.35	24	3.75	6			● 192827	● 192840
2.6	0.35	24	3.9	6			● 192828	● 192841

<sup>1</sup> Tol. 6h



All nano ring gauges have a certificate of measurement, established with SCS certified plug check gauges. The paid certificate is available on request.

# UNC, UNF ASME B1.1 ASME B1.2

VHM  
CAR

## nano

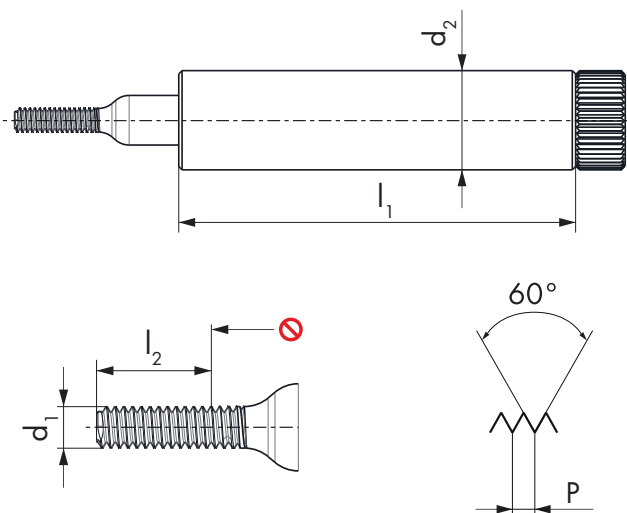

DN01 GO

DN02 NO-GO

DN01 GO

DN02 NO-GO



2B

2B

3B

3B

$\emptyset d_1$ UNC	P TPI	$\emptyset d_1$ mm	$l_1$ mm	$l_2$ GO mm	$d_2$ mm	ID	ID	ID	ID
1	64	1.854	24	6.35	6	● 191577	● 191580	● 191583	● 191586
2	54	2.184	24	6.35	6	● 191578	● 191581	● 191584	● 191587
3	48	2.515	24	6.35	6	● 191579	● 191582	● 191585	● 191588
$\emptyset d_1$ UNF	P TPI	$\emptyset d_1$ mm	$l_1$ mm	$l_2$ GO mm	$d_2$ mm	ID	ID	ID	ID
0	80	1.524	24	4.76	6	● 191637	● 191641	● 191645	● 191649
1	72	1.854	24	4.76	6	● 191638	● 191642	● 191646	● 191650
2	64	2.184	24	4.76	6	● 191639	● 191643	● 191647	● 191651
3	56	2.515	24	4.76	6	● 191640	● 191644	● 191648	● 191652



All nano thread plug gauges are SCS-certified and the paid certificate is available on request.

# UNC, UNF

ASME B1.1

DZ04: ASME B1.2 / DZ14: ASME B1.2, DC SWISS NI590

PHYN.  
KL

## nano

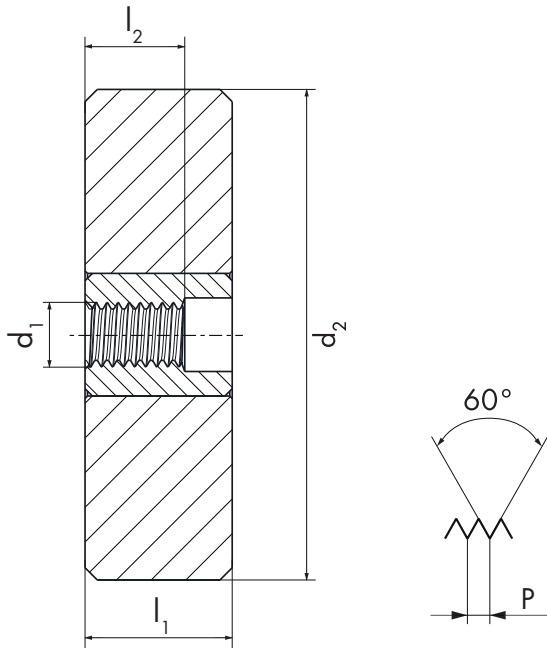

DZ04 GO

DZ14 NO-GO

DZ04 GO

DZ14 NO-GO



2A

2A

3A

3A

$\emptyset d_1$ UNC	P TPI	$\emptyset d_1$ mm	$l_1$ mm	$l_2$ GO mm	$d_2$ mm	ID	ID	ID	ID
1	64	1.854	6	2.78	20	● 191601	● 191604	● 191607	● 191610
2	56	2.184	6	3.28	20	● 191602	● 191605	● 191608	● 191611
3	48	2.515	6	3.77	20	● 191603	● 191606	● 191609	● 191612
$\emptyset d_1$ UNF	P TPI	$\emptyset d_1$ mm	$l_1$ mm	$l_2$ GO mm	$d_2$ mm	ID	ID	ID	ID
0	80	1.524	6	2.29	20	● 191669	● 191673	● 191677	● 191681
1	72	1.854	6	2.78	20	● 191670	● 191674	● 191678	● 191682
2	64	2.184	6	3.28	20	● 191671	● 191675	● 191679	● 191683
3	56	2.515	6	3.77	20	● 191672	● 191676	● 191680	● 191684



All nano ring gauges have a certificate of measurement, established with SCS certified plug check gauges. The paid certificate is available on request.

# UNC, UNF

ASME B1.1

DN04: ASME B1.2 / DN14: ASME B1.2, DC SWISS NI590

PHYN.  
KL

## nano

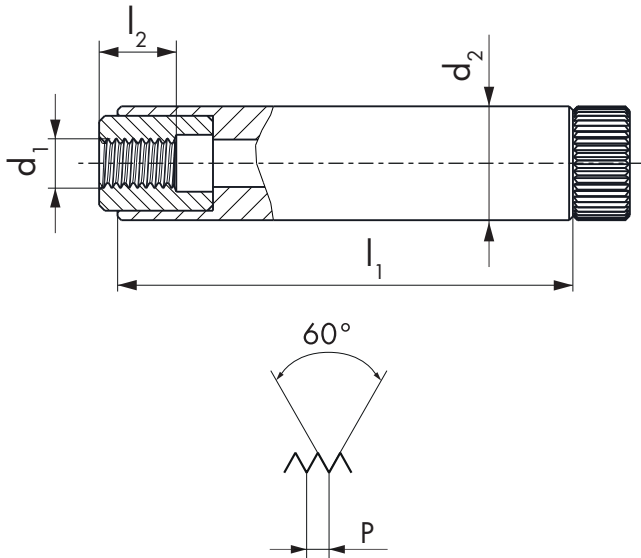

DN04 GO

DN14 NO-GO

DN04 GO

DN14 NO-GO



2A

2A

3A

3A

$\emptyset d_1$ UNC	P TPI	$\emptyset d_1$ mm	$l_1$ mm	$l_2$ GO mm	$d_2$ mm	ID	ID	ID	ID
1	64	1.854	24	2.78	6	● 191589	● 191592	● 191595	● 191598
2	56	2.184	24	3.28	6	● 191590	● 191593	● 191596	● 191599
3	48	2.515	24	3.77	6	● 191591	● 191594	● 191597	● 191600
$\emptyset d_1$ UNF	P TPI	$\emptyset d_1$ mm	$l_1$ mm	$l_2$ GO mm	$d_2$ mm	ID	ID	ID	ID
0	80	1.524	24	2.29	6	● 191653	● 191657	● 191661	● 191665
1	72	1.854	24	2.78	6	● 191654	● 191658	● 191662	● 191666
2	64	2.184	24	3.28	6	● 191655	● 191659	● 191663	● 191667
3	56	2.515	24	3.77	6	● 191656	● 191660	● 191664	● 191668



All nano ring gauges have a certificate of measurement, established with SCS certified plug check gauges. The paid certificate is available on request.

nano

DN01 GO

DN01 GO

DN02 NO-GO

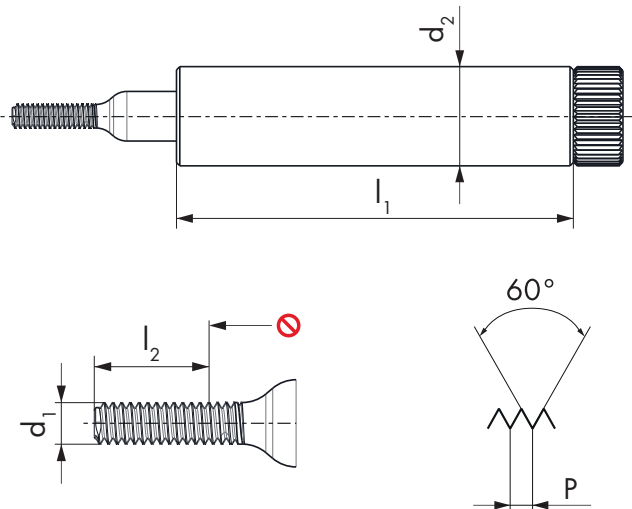

$\emptyset d_1$ S	P mm	$l_1$ mm	$l_2$ GO mm	$d_2$ mm	ID	ID	ID
0.3	0.08	24	0.9	6	● 190733	● 193242	● 190752
0.35	0.09	24	1.05	6	● 190734	● 193243	● 190753
0.4	0.1	24	1.2	6	● 190735	● 193244	● 190754
0.5	0.125	24	1.5	6	● 190736	● 193245	● 190755
0.6	0.15	24	1.8	6	● 190737	● 193246	● 190756
0.7	0.175	24	2.1	6	● 190738	● 193247	● 190757
0.8	0.2	24	2.4	6	● 190739	● 193248	● 190758
0.9	0.225	24	2.7	6	● 190740	● 193249	● 190759
1	0.25	24	3	6	● 190741	● 193250	● 190760
1.2	0.25	24	3.6	6	● 190742	● 193251	● 190761
1.4	0.3	24	4.2	6	● 190743	● 193252	● 190762



All nano thread plug gauges are SCS-certified and the paid certificate is available on request.

# nano

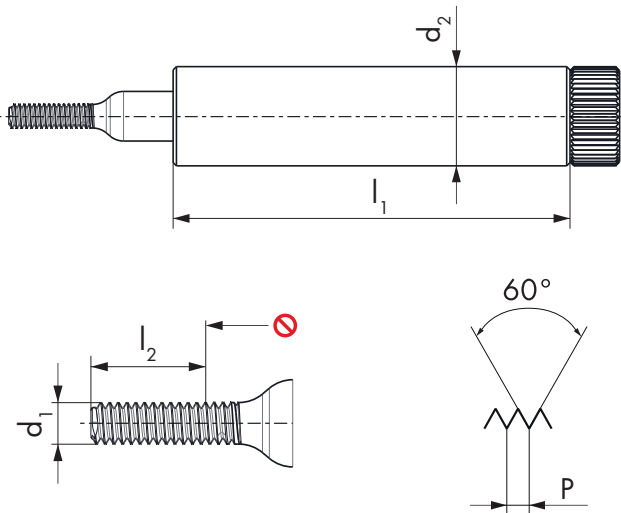

DN01 GO

DN02 NO-GO



$\emptyset d_1$ S	P mm	$l_1$ mm	$l_2$ GO mm	$d_2$ mm	ID	ID
0.3	0.08	24	0.9	6	● 190771	● 190790
0.35	0.09	24	1.05	6	● 190772	● 190791
0.4	0.1	24	1.2	6	● 190773	● 190792
0.5	0.125	24	1.5	6	● 190774	● 190793
0.6	0.15	24	1.8	6	● 190775	● 190794
0.7	0.175	24	2.1	6	● 190776	● 190795
0.8	0.2	24	2.4	6	● 190777	● 190796
0.9	0.225	24	2.7	6	● 190778	● 190797
1	0.25	24	3	6	● 190779	● 190798
1.2	0.25	24	3.6	6	● 190780	● 190799
1.4	0.3	24	4.2	6	● 190781	● 190800



All nano thread plug gauges are SCS-certified and the paid certificate is available on request.





NIHS

/ NIHS NT

DC SWISS NI584 / DZ04: STB U758-002D-F / DZ14: STB U758-002D-F, DC SWISS NI590

PHYN.  
KL

nano

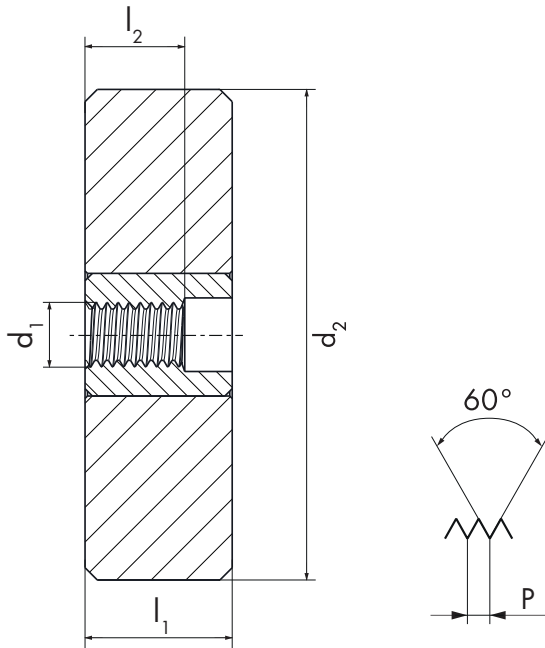

DZ04 GO

DZ14 NO-GO

DZ04 GO

DZ14 NO-GO

NIHS  
NIHS  
NIHS  
NT  
NIHS  
NT  

$\emptyset d_1$ S	P mm	$l_1$ mm	$l_2$ GO mm	$d_2$ mm	ID	ID	ID	ID
* 0.3	0.08	6	0.45	20	● 190809	● 190828	● 190847	● 190866
* 0.35	0.09	6	0.53	20	● 190810	● 190829	● 190848	● 190867
0.4	0.1	6	0.6	20	● 190811	● 190830	● 190849	● 190868
0.5	0.125	6	0.75	20	● 190812	● 190831	● 190850	● 190869
0.6	0.15	6	0.9	20	● 190813	● 190832	● 190851	● 190870
0.7	0.175	6	1.05	20	● 190814	● 190833	● 190852	● 190871
0.8	0.2	6	1.2	20	● 190815	● 190834	● 190853	● 190872
0.9	0.225	6	1.35	20	● 190816	● 190835	● 190854	● 190873
1	0.25	6	1.5	20	● 190817	● 190836	● 190855	● 190874
1.2	0.25	6	1.8	20	● 190818	● 190837	● 190856	● 190875
1.4	0.3	6	2.1	20	● 190819	● 190838	● 190857	● 190876

\* In development



All nano ring gauges have a certificate of measurement, established with SCS certified plug check gauges. The paid certificate is available on request.



nano

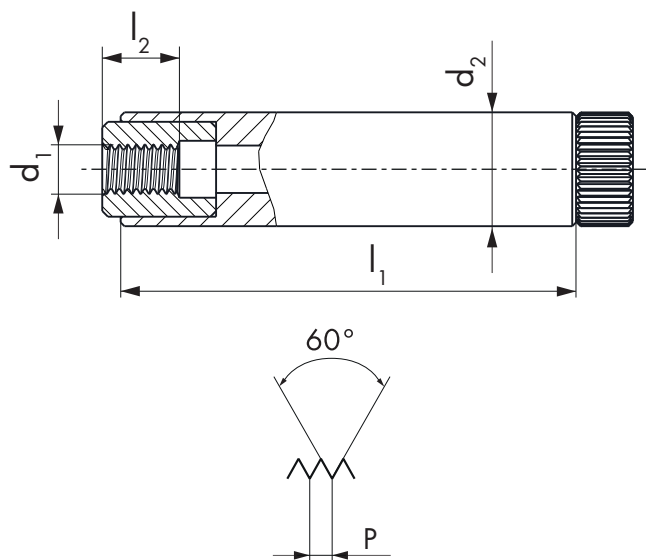

DN04 GO    DN14 NO-GO    DN04 GO    DN14 NO-GO



$\emptyset d_1$ S	P mm	$l_1$ mm	$l_2$ GO mm	$d_2$ mm	ID	ID	ID	ID
* 0.3	0.08	24	0.45	6	● 190885	● 190904	● 190923	● 190942
* 0.35	0.09	24	0.53	6	● 190886	● 190905	● 190924	● 190943
0.4	0.1	24	0.6	6	● 190887	● 190906	● 190925	● 190944
0.5	0.125	24	0.75	6	● 190888	● 190907	● 190926	● 190945
0.6	0.15	24	0.9	6	● 190889	● 190908	● 190927	● 190946
0.7	0.175	24	1.05	6	● 190890	● 190909	● 190928	● 190947
0.8	0.2	24	1.2	6	● 190891	● 190910	● 190929	● 190948
0.9	0.225	24	1.35	6	● 190892	● 190911	● 190930	● 190949
1	0.25	24	1.5	6	● 190893	● 190912	● 190931	● 190950
1.2	0.25	24	1.8	6	● 190894	● 190913	● 190932	● 190951
1.4	0.3	24	2.1	6	● 190895	● 190914	● 190933	● 190952

\*In development



All nano ring gauges have a certificate of measurement, established with SCS certified plug check gauges. The paid certificate is available on request.

nano

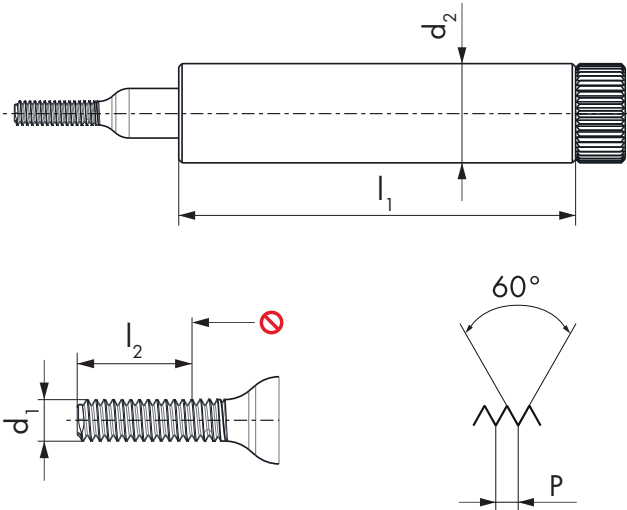

DN01 GO

DN01 GO

DN02 NO-GO



$\emptyset d_1$ SF	P mm	$l_1$ mm	$l_2$ GO mm	$d_2$ mm	ID	ID	ID
1.4	0.2	24	4.2	6	● 190744	● 193256	● 190763
1.6	0.2	24	3	6	● 190745	● 193257	● 190764
1.8	0.2	24	3	6	● 190746	● 193258	● 190765
2	0.2	24	3	6	● 190747	● 193259	● 190766
2.2	0.2	24	3	6	● 190748	● 193260	● 190767
2.2	0.25	24	3	6	● 190749	● 193261	● 190768
2.5	0.2	24	3	6	● 190750	● 193262	● 190769
2.5	0.25	24	3	6	● 190751	● 193263	● 190770

nano



All nano thread plug gauges are SCS-certified and the paid certificate is available on request.

# nano

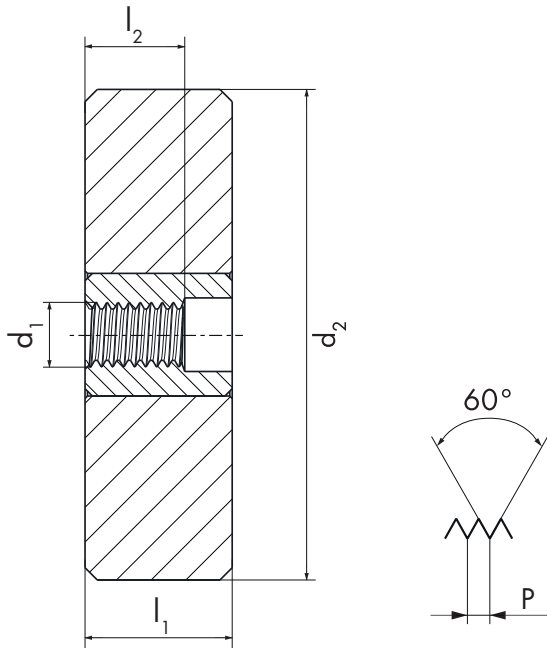

DZ04 GO

DZ14 NO-GO



$\emptyset d_1$ SF	P mm	$l_1$ mm	$l_2$ GO mm	$d_2$ mm	ID	ID
1.4	0.2	6	2.1	20	● 190820	● 190839
1.6	0.2	6	1.8	20	● 190821	● 190840
1.8	0.2	6	1.8	20	● 190822	● 190841
2	0.2	6	1.8	20	● 190823	● 190842
2.2	0.2	6	1.8	20	● 190824	● 190843
2.2	0.25	6	2.25	20	● 190825	● 190844
2.5	0.2	6	1.8	20	● 190826	● 190845
2.5	0.25	6	2.25	20	● 190827	● 190846



All nano ring gauges have a certificate of measurement, established with SCS certified plug check gauges. The paid certificate is available on request.

nano

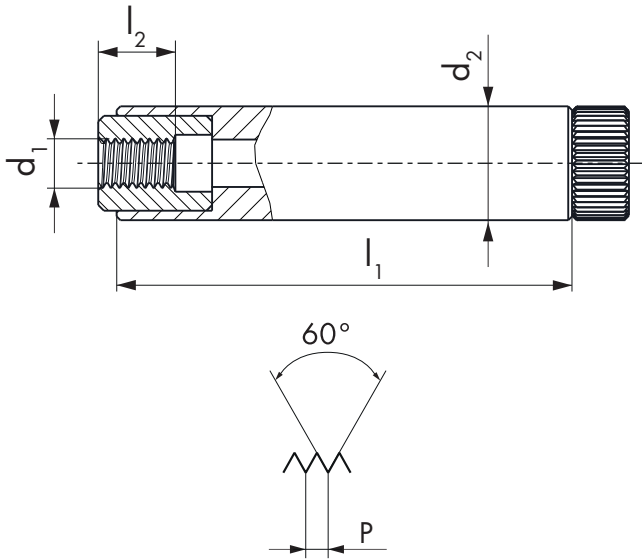

DN04 GO

DN14 NO-GO



$\emptyset d_1$ SF	P mm	$l_1$ mm	$l_2$ GO mm	$d_2$ mm	ID	ID
1.4	0.2	24	2.1	6	● 190896	● 190915
1.6	0.2	24	1.8	6	● 190897	● 190916
1.8	0.2	24	1.8	6	● 190898	● 190917
2	0.2	24	1.8	6	● 190899	● 190918
2.2	0.2	24	1.8	6	● 190900	● 190919
2.2	0.25	24	2.25	6	● 190901	● 190920
2.5	0.2	24	1.8	6	● 190902	● 190921
2.5	0.25	24	2.28	6	● 190903	● 190922



All nano ring gauges have a certificate of measurement, established with SCS certified plug check gauges. The paid certificate is available on request.

nano

DN01 GO

DN02 NO-GO

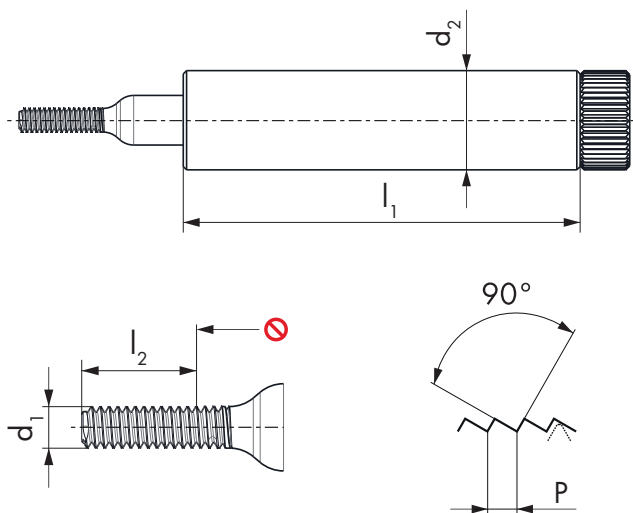

$\emptyset d_1$ SL	P mm	$l_1$ mm	$l_2$ GO mm	$d_2$ mm	ID	ID
0.5	0.1	24	1.5	6	● 600178	● 600186
0.6	0.125	24	1.8	6	● 600179	● 600187
0.7	0.15	24	2.1	6	● 600180	● 600188
0.8	0.15	24	2.4	6	● 600181	● 600189
0.9	0.175	24	2.7	6	● 600182	● 600190
1	0.2	24	3	6	● 600183	● 600191
1.2	0.2	24	3.6	6	● 600184	● 600192
1.4	0.25	24	4.2	6	● 600185	● 600193



All nano thread plug gauges are SCS-certified and the paid certificate is available on request.

**nano**

RN05-1 GO

RN15-1 GO

RN05-1 GO

RN15-1 GO

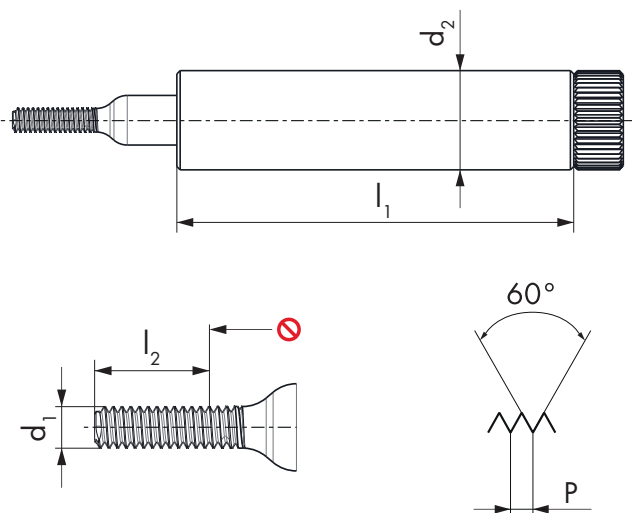

**5h**

**5h**

**6h**

**6h**

$\emptyset d_1$ M	P mm	$l_1$ mm	$l_2$ GO mm	$d_2$ mm	ID	ID	ID	ID
0.3	0.08	24	0.61	6	● 192884	● 192892		
0.35	0.09	24	0.71	6	● 192885	● 192893		
0.4	0.1	24	0.8	6	● 192886	● 192894		
0.5	0.125	24	1	6	● 192887	● 192895		
0.6	0.15	24	1.2	6	● 192888	● 192896		
0.7	0.175	24	1.4	6	● 192889	● 192897		
0.8	0.2	24	1.6	6	● 192890	● 192898		
0.9	0.225	24	1.8	6	● 192891	● 192899		
1	0.25	24	2	6			● 191499	● 191508
1.2	0.25	24	2.3	6			● 191500	● 191509
1.4	0.3	24	2.7	6			● 191501	● 191510

**6g**

**6g**

$\emptyset d_1$ M	P mm	$l_1$ mm	$l_2$ GO mm	$d_2$ mm	ID	ID
1.6	0.35	24	3.1	6	● 191517	● 191535
1.8	0.35	24	3.4	6	● 191518	● 191536
2	0.4	24	3.8	6	● 191519	● 191537
2.3	0.4	24	4.25	6	● 191520	● 191538
2.5	0.45	24	4.65	6	● 191521	● 191539
2.6	0.45	24	4.8	6	● 191522	● 191540



SCS certificate included.

nano

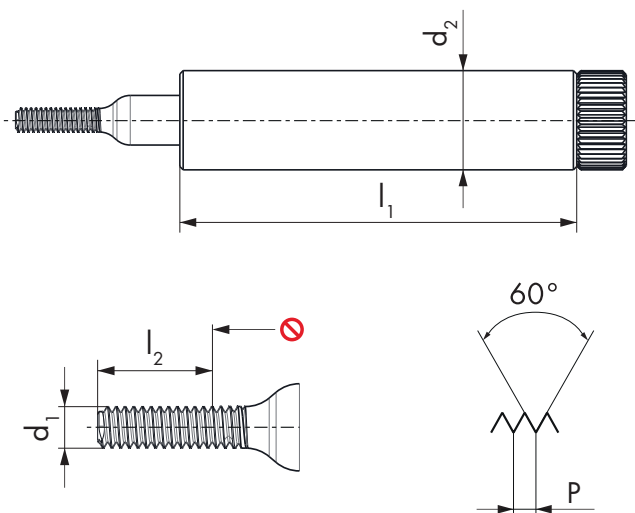

RN05-2  
NO-GO

RN15-2  
NO-GO

RN05-2  
NO-GO

RN15-2  
NO-GO



5h

5h

6h

6h

$\emptyset d_1$ M	P mm	$l_1$ mm	$l_2$ GO mm	$d_2$ mm	ID	ID	ID	ID
0.3	0.08	24	0.61	6	● 192900	● 192908		
0.35	0.09	24	0.71	6	● 192901	● 192909		
0.4	0.1	24	0.8	6	● 192902	● 192910		
0.5	0.125	24	1	6	● 192903	● 192911		
0.6	0.15	24	1.2	6	● 192904	● 192912		
0.7	0.175	24	1.4	6	● 192905	● 192913		
0.8	0.2	24	1.6	6	● 192906	● 192914		
0.9	0.225	24	1.8	6	● 192907	● 192915		
1	0.25	24	2	6			● 191502	● 191511
1.2	0.25	24	2.3	6			● 191503	● 191512
1.4	0.3	24	2.7	6			● 191504	● 191513

6g

6g

$\emptyset d_1$ M	P mm	$l_1$ mm	$l_2$ GO mm	$d_2$ mm	ID	ID
1.6	0.35	24	3.1	6	● 191523	● 191541
1.8	0.35	24	3.4	6	● 191524	● 191542
2	0.4	24	3.8	6	● 191525	● 191543
2.3	0.4	24	4.25	6	● 191526	● 191544
2.5	0.45	24	4.65	6	● 191527	● 191545
2.6	0.45	24	4.8	6	● 191528	● 191546



SCS certificate included.





ISO DIN 13  
ISO 1502

VHM  
CAR

nano

RN05-3  
WEAR

RN15-3  
WEAR

RN05-3  
WEAR

RN15-3  
WEAR

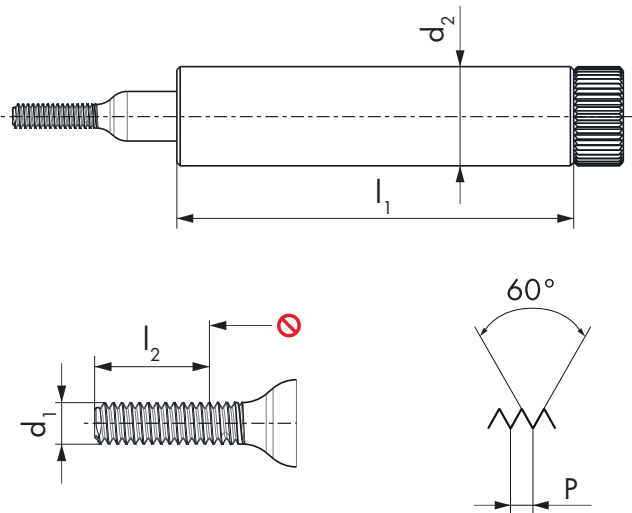

6h

6h

6g

6g

$\emptyset d_1$ M	P mm	$l_1$ mm	$l_2$ GO mm	$d_2$ mm	ID	ID	ID	ID
1	0.25	24	2	6	● 191505	● 191514		
1.2	0.25	24	2.3	6	● 191506	● 191515		
1.4	0.3	24	2.7	6	● 191507	● 191516		
1.6	0.35	24	3.1	6			● 191529	● 191547
1.8	0.35	24	3.4	6			● 191530	● 191548
2	0.4	24	3.8	6			● 191531	● 191549
2.3	0.4	24	4.25	6			● 191532	● 191550
2.5	0.45	24	4.65	6			● 191533	● 191551
2.6	0.45	24	4.8	6			● 191534	● 191552



SCS certificate included.



nano

RN05-1 GO

RN15-1 GO

RN05-1 GO

RN15-1 GO

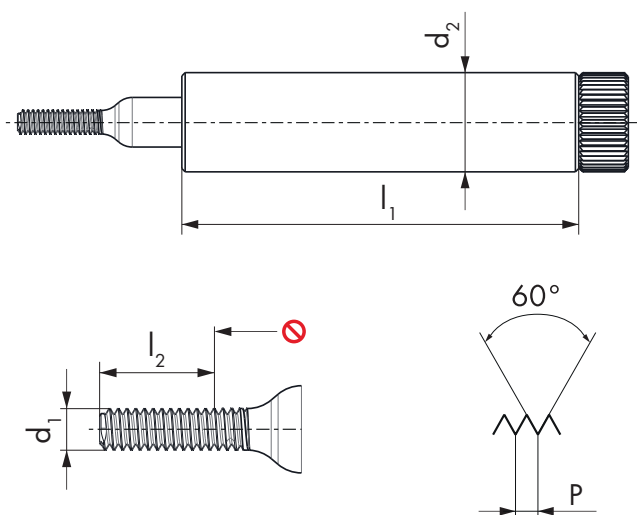

4h

4h

6h

6h

$\emptyset d_1$ MF	P mm	$l_1$ mm	$l_2$ GO mm	$d_2$ mm	ID	ID	ID	ID
1.4	0.2	24	2.5	6	● 191256	● 191298	● 192932	● 192945
1.6	0.2	24	2.2	6	● 195874	● 195876	● 192933	● 192946
1.8	0.2	24	2.2	6	● 197711	● 197712	● 192934	● 192947
2	0.2	24	2.2	6	● 197724	● 197725	● 192935	● 192948
2	0.25	24	2.75	6	● 197726	● 197727	● 192936	● 192949
2.2	0.2	24	2.2	6	● 197713	● 197714	● 192937	● 192950
2.2	0.25	24	2.75	6	● 197715	● 197716	● 192938	● 192951
2.3	0.2	24	2.2	6	● 197717	● 197718	● 192939	● 192952
2.3	0.25	24	2.75	6	● 197719	● 197720	● 192940	● 192953
2.5	0.2	24	2.2	6	● 197721	● 197722	● 192941	● 192954
2.5	0.25	24	2.75	6	● 190683	● 197723	● 192942	● 192955
							6g	6g
$\emptyset d_1$ MF	P mm	$l_1$ mm	$l_2$ GO mm	$d_2$ mm	ID	ID		
2.5	0.35	24	4.45	6		● 192943	● 192956	
2.6	0.35	24	4.6	6		● 192944	● 192957	



SCS certificate included.

nano

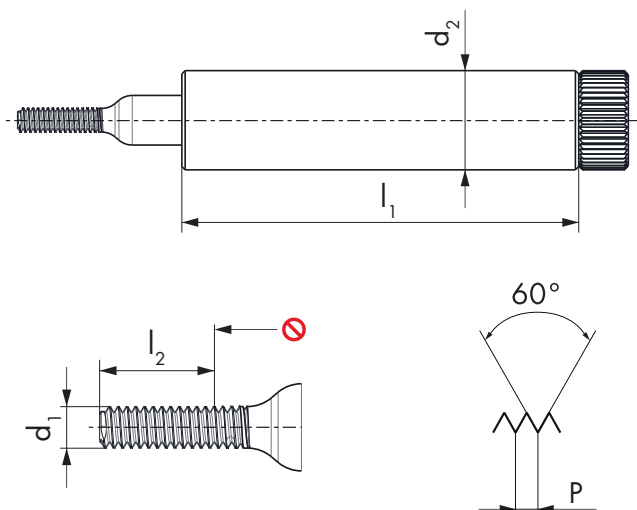

**RN05-2  
NO-GO**

**RN15-2  
NO-GO**

**RN05-2  
NO-GO**

**RN15-2  
NO-GO**



**4h**

**4h**

**6h**

**6h**

$\emptyset d_1$ MF	P mm	$l_1$ mm	$l_2$ GO mm	$d_2$ mm	ID	ID	ID	ID
1.4	0.2	24	2.5	6	● 191270	● 197728	● 192958	● 192971
1.6	0.2	24	1.6	6	● 195875	● 195877	● 192959	● 192972
1.8	0.2	24	1.6	6	● 197729	● 197730	● 192960	● 192973
2	0.2	24	1.6	6	● 199060	● 199061	● 192961	● 192974
2	0.25	24	2	6	● 199062	● 199063	● 192962	● 192975
2.2	0.2	24	1.6	6	● 197731	● 197732	● 192963	● 192976
2.2	0.25	24	2	6	● 197733	● 199364	● 192964	● 192977
2.3	0.2	24	1.6	6	● 199053	● 199054	● 192965	● 192978
2.3	0.25	24	2	6	● 199055	● 199056	● 192966	● 192979
2.5	0.2	24	1.6	6	● 199057	● 199058	● 192967	● 192980
2.5	0.25	24	2	6	● 190686	● 199059	● 192968	● 192981

**6g**

**6g**

$\emptyset d_1$ MF	P mm	$l_1$ mm	$l_2$ GO mm	$d_2$ mm	ID	ID
2.5	0.35	24	4.45	6	● 192969	● 192982
2.6	0.35	24	4.6	6	● 192970	● 192983



SCS certificate included.

nano

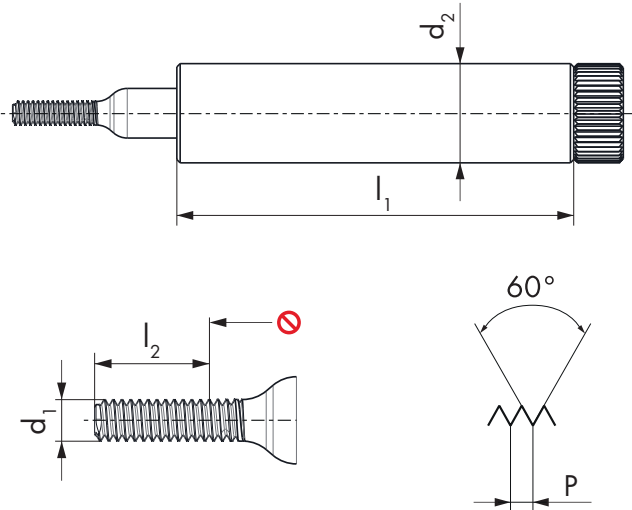

**RN05-3  
WEAR**

**RN15-3  
WEAR**

**RN05-3  
WEAR**

**RN15-3  
WEAR**



4h

4h

6h

6h

$\emptyset d_1$ MF	P mm	$l_1$ mm	$l_2$ G0 mm	$d_2$ mm	ID	ID	ID	ID
1.4	0.2	24	2.5	6	● 191284	● 191326	● 192984	● 192997
1.6	0.2	24	1.6	6	● 199064	● 199065	● 192985	● 192998
1.8	0.2	24	1.6	6	● 199066	● 199067	● 192986	● 192999
2	0.2	24	1.6	6	● 199360	● 199361	● 192987	● 193000
2	0.25	24	2	6	● 199362	● 199363	● 192988	● 193001
2.2	0.2	24	1.6	6	● 199068	● 199069	● 192989	● 193002
2.2	0.25	24	2	6	● 199070	● 199071	● 192990	● 193003
2.3	0.2	24	1.6	6	● 199072	● 199073	● 192991	● 193004
2.3	0.25	24	2	6	● 199074	● 199075	● 192992	● 193005
2.5	0.2	24	1.6	6	● 199076	● 199077	● 192993	● 193006
2.5	0.25	24	2	6	● 199358	● 199359	● 192994	● 193007
							6g	6g
$\emptyset d_1$ MF	P mm	$l_1$ mm	$l_2$ G0 mm	$d_2$ mm	ID	ID		
2.5	0.35	24	4.45	6			● 192995	● 193008
2.6	0.35	24	4.6	6			● 192996	● 193009



SCS certificate included.

# UNC, UNF ASME B1.1 DC SWISS NI582

VHM  
CAR

nano

RN05-1 GO

RN15-1 GO

RN05-1 GO

RN15-1 GO

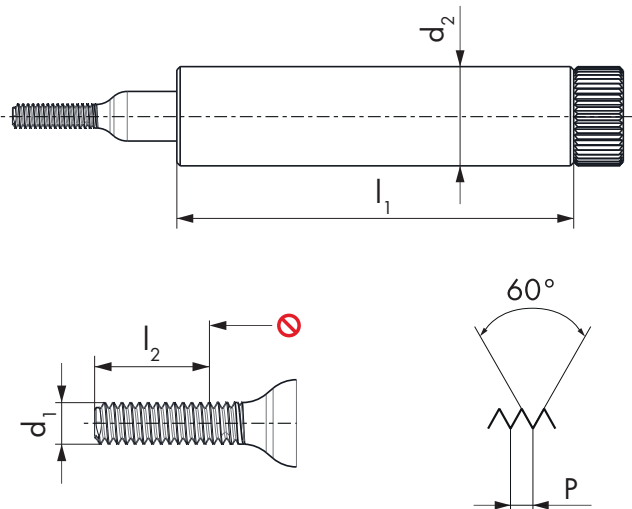

2A

2A

3A

3A

$\emptyset d_1$ UNC	P TPI	$\emptyset d_1$ mm	$l_1$ mm	$l_2$ GO mm	$d_2$ mm	ID	ID	ID	ID
1	64	1.854	24	3.58	6	● 191613	● 191619	● 191625	● 191631
2	56	2.184	24	4.18	6	● 191614	● 191620	● 191626	● 191632
3	48	2.515	24	4.83	6	● 191615	● 191621	● 191627	● 191633
$\emptyset d_1$ UNF	P TPI	$\emptyset d_1$ mm	$l_1$ mm	$l_2$ GO mm	$d_2$ mm	ID	ID	ID	ID
0	80	1.524	24	2.92	6	● 191685	● 191693	● 191701	● 191709
1	72	1.854	24	3.49	6	● 191686	● 191694	● 191702	● 191710
2	64	2.184	24	4.07	6	● 191687	● 191695	● 191703	● 191711
3	56	2.515	24	4.68	6	● 191688	● 191696	● 191704	● 191712



SCS certificate included.



# UNC, UNF ASME B1.1 DC SWISS NI582

VHM  
CAR

nano

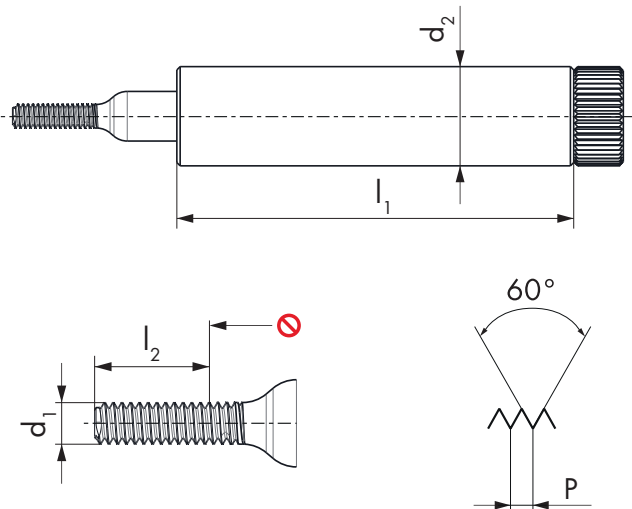

RN05-2  
NO-GO

RN15-2  
NO-GO

RN05-2  
NO-GO

RN15-2  
NO-GO



2A

2A

3A

3A

$\emptyset d_1$ UNC	P TPI	$\emptyset d_1$ mm	$l_1$ mm	$l_2$ GO mm	$d_2$ mm	ID	ID	ID	ID
1	64	1.854	24	3.58	6	● 191616	● 191622	● 191628	● 191634
2	56	2.184	24	4.18	6	● 191617	● 191623	● 191629	● 191635
3	48	2.515	24	4.83	6	● 191618	● 191624	● 191630	● 191636
$\emptyset d_1$ UNF	P TPI	$\emptyset d_1$ mm	$l_1$ mm	$l_2$ GO mm	$d_2$ mm	ID	ID	ID	ID
0	80	1.524	24	2.92	6	● 191689	● 191697	● 191705	● 191713
1	72	1.854	24	3.49	6	● 191690	● 191698	● 191706	● 191714
2	64	2.184	24	4.07	6	● 191691	● 191699	● 191707	● 191715
3	56	2.515	24	4.68	6	● 191692	● 191700	● 191708	● 191716



SCS certificate included.

**nano**

RN05-1 GO

RN15-1 GO

RN05-1 GO

RN15-1 GO

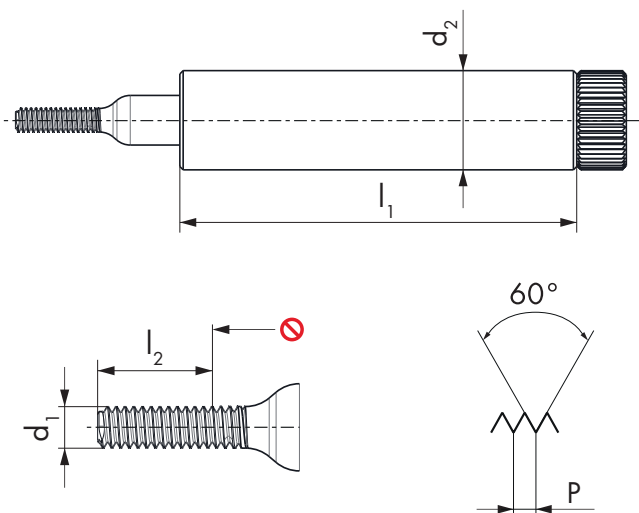

$\emptyset d_1$ S	P mm	$l_1$ mm	$l_2$ GO mm	$d_2$ mm	ID	ID	ID	ID
0.3	0.08	24	0.61	6	● 190961	● 190999	● 191037	● 191075
0.35	0.09	24	0.71	6	● 190962	● 191000	● 191038	● 191076
0.4	0.1	24	0.8	6	● 190963	● 191001	● 191039	● 191077
0.5	0.125	24	1	6	● 190964	● 191002	● 191040	● 191078
0.6	0.15	24	1.2	6	● 190965	● 191003	● 191041	● 191079
0.7	0.175	24	1.4	6	● 190966	● 191004	● 191042	● 191080
0.8	0.2	24	1.6	6	● 190967	● 191005	● 191043	● 191081
0.9	0.225	24	1.8	6	● 190968	● 191006	● 191044	● 191082
1	0.25	24	2	6	● 190969	● 191007	● 191045	● 191083
1.2	0.25	24	2.3	6	● 190970	● 191008	● 191046	● 191084
1.4	0.3	24	2.7	6	● 190971	● 191009	● 191047	● 191085



SCS certificate included.

**nano**

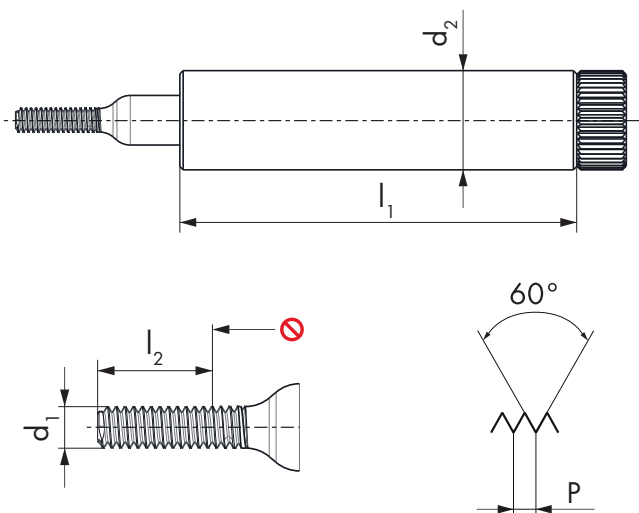

**RN05-2  
NO-GO**

**RN15-2  
NO-GO**

**RN05-2  
NO-GO**

**RN15-2  
NO-GO**



**NIHS**

**NIHS**

**NIHS  
NT**

**NIHS  
NT**

$\emptyset d_1$ S	P mm	$l_1$ mm	$l_2$ GO mm	$d_2$ mm	ID	ID	ID	ID
0.3	0.08	24	0.61	6	● 190980	● 191018	● 191056	● 191094
0.35	0.09	24	0.71	6	● 190981	● 191019	● 191057	● 191095
0.4	0.1	24	0.8	6	● 190982	● 191020	● 191058	● 191096
0.5	0.125	24	1	6	● 190983	● 191021	● 191059	● 191097
0.6	0.15	24	1.2	6	● 190984	● 191022	● 191060	● 191098
0.7	0.175	24	1.4	6	● 190985	● 191023	● 191061	● 191099
0.8	0.2	24	1.6	6	● 190986	● 191024	● 191062	● 191100
0.9	0.225	24	1.8	6	● 190987	● 191025	● 191063	● 191101
1	0.25	24	2	6	● 190988	● 191026	● 191064	● 191102
1.2	0.25	24	2.3	6	● 190989	● 191027	● 191065	● 191103
1.4	0.3	24	2.7	6	● 190990	● 191028	● 191066	● 191104



SCS certificate included.



nano

RN05-1 GO

RN15-1 GO

RN05-1 GO

RN15-1 GO

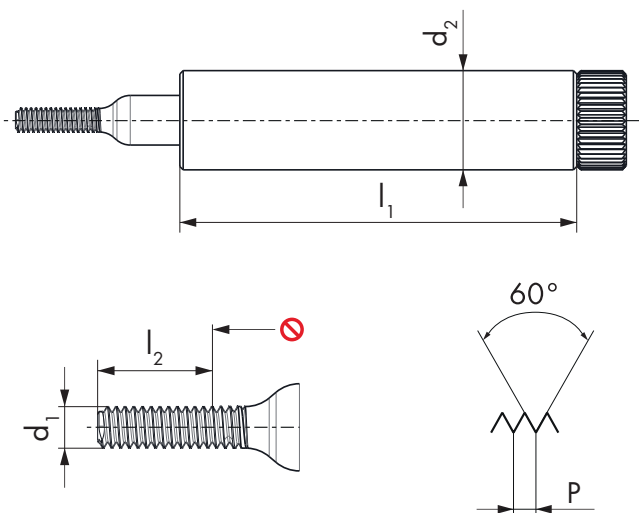

$\emptyset d_1$ SF	P mm	$l_1$ mm	$l_2$ GO mm	$d_2$ mm	ID	ID	ID	ID
1.4	0.2	24	2.5	6	● 190972	● 191010	● 191048	● 191086
1.6	0.2	24	2.2	6	● 190973	● 191011	● 191049	● 191087
1.8	0.2	24	2.2	6	● 190974	● 191012	● 191050	● 191088
2	0.2	24	2.2	6	● 190975	● 191013	● 191051	● 191089
2.2	0.2	24	2.2	6	● 190976	● 191014	● 191052	● 191090
2.2	0.25	24	2.75	6	● 190977	● 191015	● 191053	● 191091
2.5	0.2	24	2.2	6	● 190978	● 191016	● 191054	● 191092
2.5	0.25	24	2.75	6	● 190979	● 191017	● 191055	● 191093



SCS certificate included.

nano

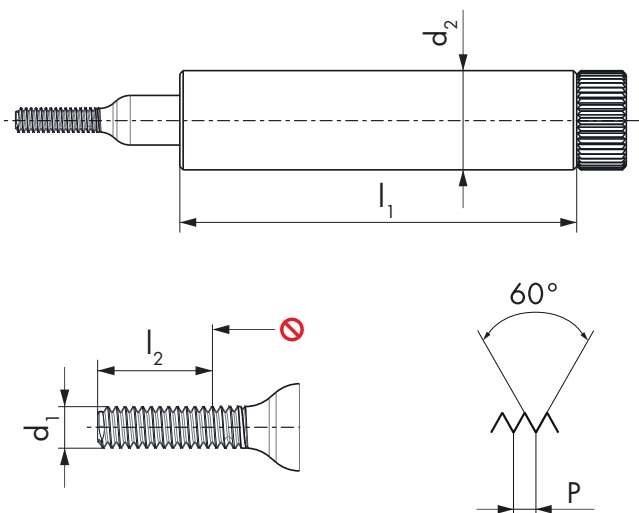

RN05-2  
NO-GO

RN15-2  
NO-GO

RN05-2  
NO-GO

RN15-2  
NO-GO



$\emptyset d_1$ SF	P mm	$l_1$ mm	$l_2$ GO mm	$d_2$ mm	ID	ID	ID	ID
1.4	0.2	24	2.5	6	● 190991	● 191029	● 191067	● 191105
1.6	0.2	24	1.6	6	● 190992	● 191030	● 191068	● 191106
1.8	0.2	24	1.6	6	● 190993	● 191031	● 191069	● 191107
2	0.2	24	1.6	6	● 190994	● 191032	● 191070	● 191108
2.2	0.2	24	1.6	6	● 190995	● 191033	● 191071	● 191109
2.2	0.25	24	2	6	● 190996	● 191034	● 191072	● 191110
2.5	0.2	24	1.6	6	● 190997	● 191035	● 191073	● 191111
2.5	0.25	24	2	6	● 190998	● 191036	● 191074	● 191112



SCS certificate included.

nano

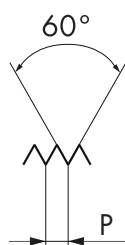
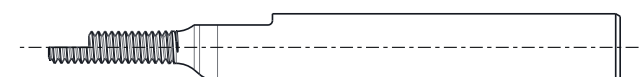
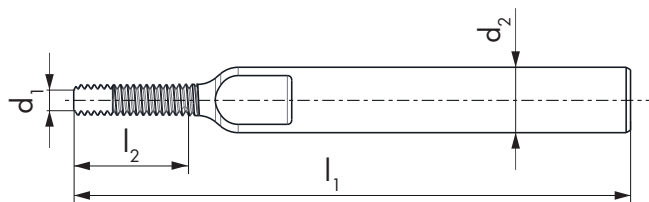

EN00



NIHS

$\varnothing d_1$ S	P mm	$l_1$ mm	$l_2$ GO mm	$d_2$ mm	ID
0.3	0.08	39	1.28	3	● 192747
0.35	0.09	39	1.44	3	● 192748
0.4	0.1	39	1.6	3	● 192749
0.5	0.125	39	2	3	● 192750
0.6	0.15	39	2.4	3	● 192751
0.7	0.175	39	2.8	3	● 192752
0.8	0.2	39	3.2	3	● 192753
0.9	0.225	39	3.6	3	● 192754
1	0.25	39	4	3	● 192755
1.2	0.25	39	4	3	● 192756
1.4	0.3	39	4.8	3	● 192757

Der DC SWISS Kalibrier-Gewindelehdorn wird zur Eichung von Messmaschinen verwendet. Die Kalibrierlehren aus unserem Katalog, oder nach Ihren spezifischen Anforderungen gefertigt, werden mit einem SCS-Messzertifikat geliefert. Dieses bestätigt, dass der Kontrollprozess während der Herstellung gewissenhaft gemäß ISO 17025 erfolgt ist. Es bescheinigt die Qualität der messtechnischen Ausrüstung der DC NANO TOOLS SA (SCS 0143), Kompetenzzentrum und Mitglied der DC-Gruppe.

The DC SWISS calibration thread plug gauge is used for the calibration of measuring machines. The calibration gauges from our catalogue, or made to your specific requirements, are delivered with a SCS measurement certificate. This confirms that the control process during production has been conscientiously followed to ISO 17025. It attests to the quality of the metrological equipment of DC NANO TOOLS SA (SCS 0143), centre of competence and member of the DC Group.



SCS certificate included.

Die von DC SWISS registrierte und geschützte Marke Micro-Safelock identifiziert die Werkzeuge, die vom Safelock-System profitieren und garantiert die von DC SWISS entwickelte und patentierte selbstblockierende Schraubverbindung.

Die Komponenten einer herkömmlichen selbstsichernden, asymmetrischen Gewindeverbindung können bei Durchmessern unter 1.5 mm aufgrund der besonderen Anforderungen an die Toleranzfelder für die Innen- und Aussengewinde nicht unter Einsatz der üblichen Produktions- und Messweisen industriell gefertigt werden.

Unter dem Markennamen Micro-Safelock wurde so ein selbstsicherndes, asymmetrisches, genormtes Gewindegewinde für Durchmesser von 0.30 bis 1.40 mm entwickelt und patentiert, das die Toleranzen von Mini-Gewinden einhält. Es ist ebenso vibrations- und stossfest wie die grösseren Gewindegewinde, da es auf der gleichen Technologie beruht und ebenfalls einen Flankenwinkel von  $30^\circ$  (Innengewinde/Mutter) aufweist, sodass sich die Schraubchen leicht montieren lassen.

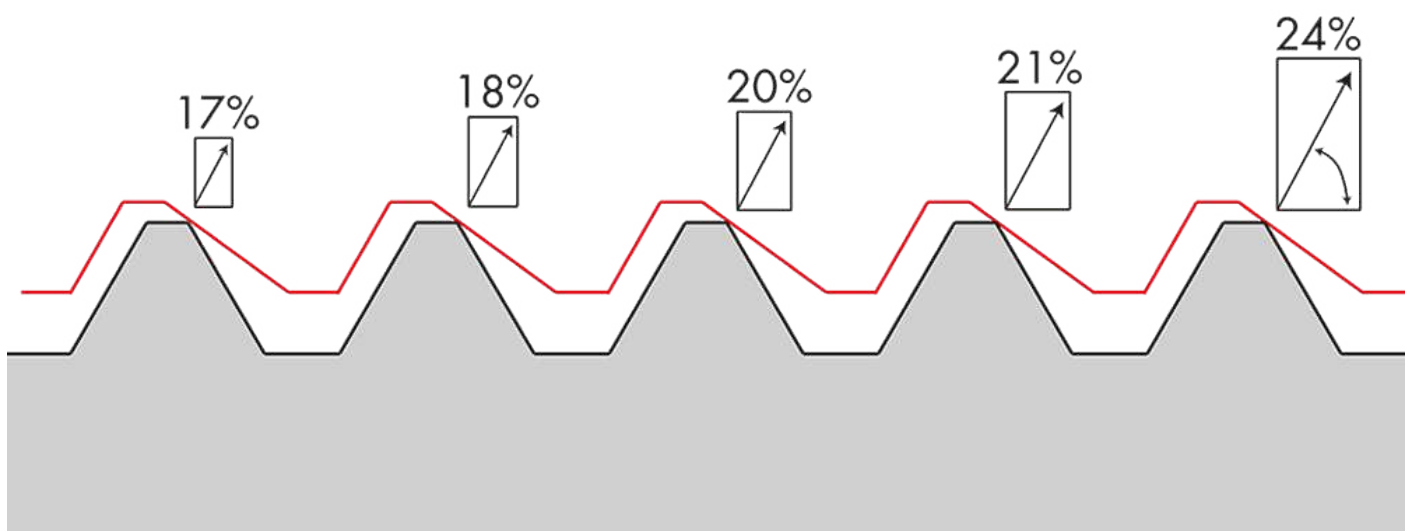

Durch die beim Anziehen angewendete Zugkraft zentriert sich die Schraube selbst, während ihre Gewindeflanken sich mit dem asymmetrischen Profil (der Steigung) des Innengewindes verzahnen. Durch den tangentialen Kontakt verteilt sich die Last gleichmässig auf alle Gewindegänge.

Indem die Schraubengewinde auf der gesamten Länge belastet und die ersten Gewindegänge entsprechend entlastet werden, ist hier die Gefährdung der Schraubenverbindung durch Ermüdung signifikant verringert. Daher können solche Verbindungen auch ohne Qualitätsverlust mehrfach montiert und demontiert werden.

Um möglichst alle masslichen Anforderungen erfüllen zu können, wurde die Seele der Schraube gegenüber einer Schraube mit gleich grossem NIHS- oder M-Gewinde und  $60^\circ$  Flankenwinkel grosszügig verstärkt.

Die Gänge sind enger als bei einem Gewinde nach NIHS-Norm, sodass beide Befestigungselemente bei gleicher Gewindelänge über eine grössere Kontaktfläche verfügen. Das hat beträchtliche Vorteile – insbesondere dann, wenn weiche Werkstoffe und Schraubchen mit kleinem Kopf und kurzem Gewinde verwendet werden.

## DIE VORTEILE DES SELBSTSICHERNDEN GEWINDEPROFILS

- Verteilung der Zugkraft auf die gesamte Länge des Gewindes
- Bis zu 25 % geringeres nominales Klemmdrehmoment im Vergleich zur herkömmlichen Gewindeverbindung
- Rein mechanische Lösung, ohne chemische Hilfsmittel

## DIE VORTEILE DER SCHRAUBE

- Gewinde mit anwendungsspezifischen Toleranzen: sichert den permanenten Kontakt zwischen Schraube und Mutter
- Feingewinde: bietet eine grössere Kontaktfläche bei gleicher Gewindelänge
- Höhere Zugfestigkeit: durch den um 19 % grösseren Gewinde-Innendurchmesser (mehr als 40 % im Querschnitt)
- Mehrmaliges Auf- und Abschrauben ohne Beeinträchtigung der mechanischen Eigenschaften

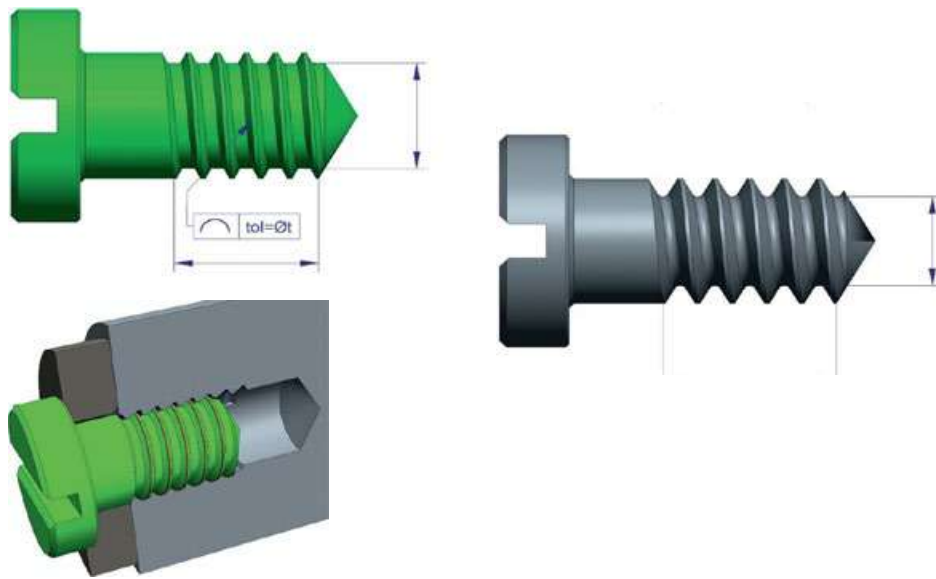

Wie zahlreiche Stossfestigkeitstests eindeutig gezeigt haben, sind diese Gewindeverbindungen absolut zuverlässig. Sie stellen daher eine überzeugende Lösung für alle Fälle dar, in denen die Festigkeit einer Schraubenverbindung unter besonders schwierigen Bedingungen gewährleistet werden muss.

Die bei den Prüfungen angewendeten Anzugsdrehmomente lagen um 25 % unter den von den Herstellern der chemischen Schraubensicherungsmittel empfohlenen Werten.

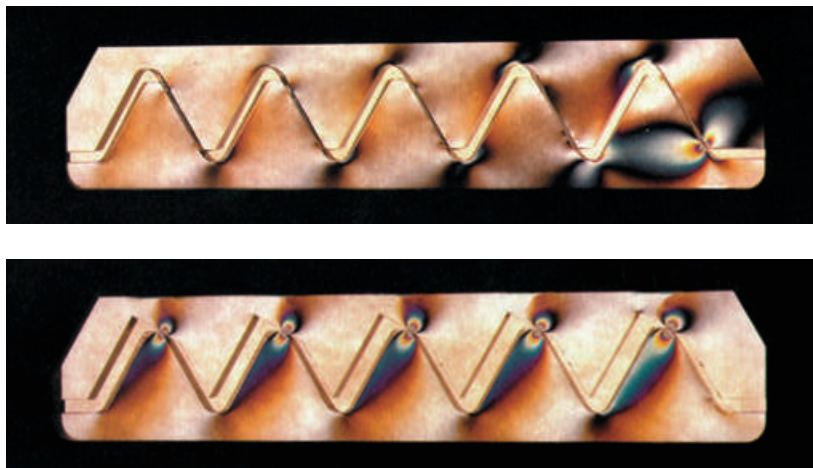

# SAFELOCK MASSE UND NORMEN

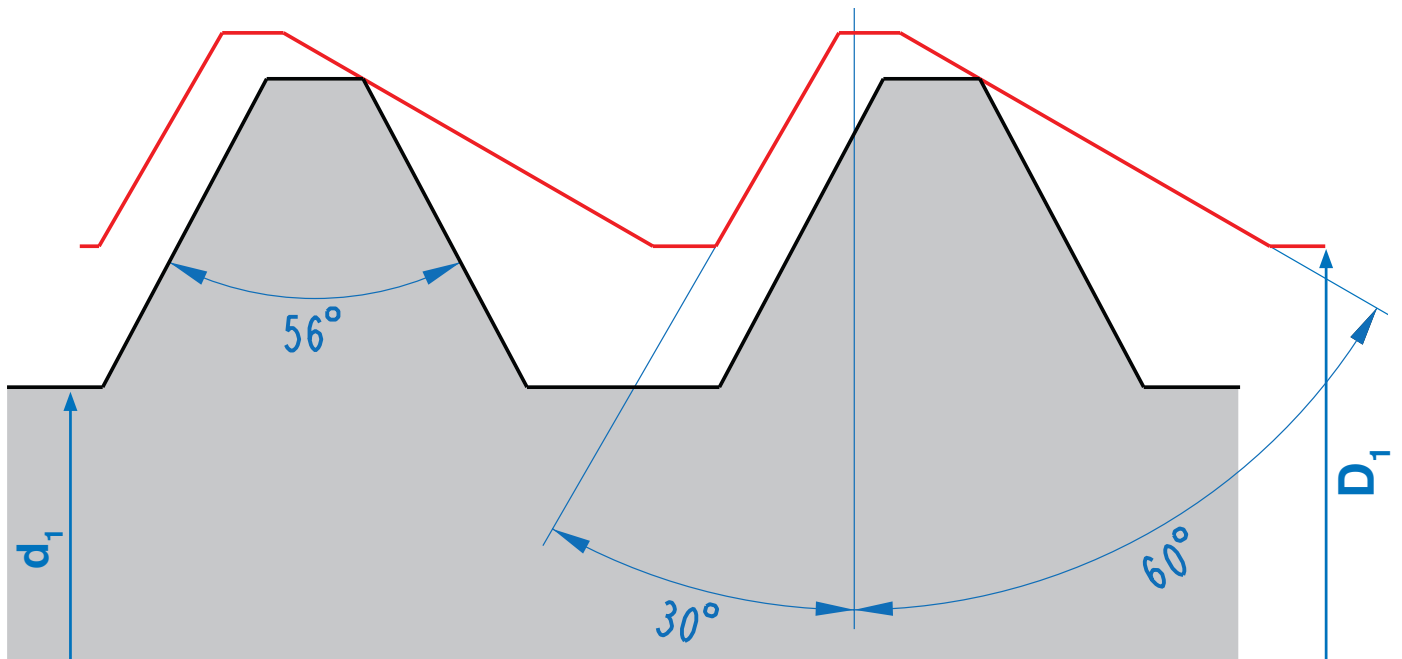

Abmessung	Steigung mm	$d_1$ mini mm	$d_1$ maxi mm	Flankenwinkel Mutter	Flankenwinkel Schraube	$d_1$
SL 0.3	0.06	0.264	0.278	30°/60°	56°	0.247
SL 0.35	0.06	0.314	0.328	30°/60°	56°	0.297
SL 0.4	0.08	0.356	0.372	30°/60°	56°	0.331
SL 0.5	0.1	0.448	0.466	30°/60°	56°	0.416
SL 0.6	0.125	0.538	0.559	30°/60°	56°	0.496
SL 0.7	0.15	0.628	0.651	30°/60°	56°	0.576
SL 0.8	0.15	0.728	0.751	30°/60°	56°	0.676
SL 0.9	0.175	0.818	0.844	30°/60°	56°	0.756
SL 1.0	0.2	0.908	0.936	30°/60°	56°	0.836
SL 1.2	0.2	1.108	1.136	30°/60°	56°	1.036
SL 1.4	0.25	1.288	1.321	30°/60°	56°	1.197

# MICRO SAFELOCK



The Micro-Safelock brand, registered and protected by DC SWISS, identifies the tools benefiting from the Safelock system guaranteeing the threaded self-locking assembly, developed and patented by DC SWISS.

For diameters of less than 1.5 mm, the requirements for the interior and exterior threading tolerance are such that conventional method for production and measurement do not permit the industrial production of components for conventional self-locking asymmetrical screw assemblies.

This standard self-locking asymmetrical threaded micro-assembly for diameters ranging from 0.30 to 1.40 mm, which adheres to the tolerances inherent in micro-screw threads, has been designed and patented under the name of Micro-Safelock. It offers exceptional performance in terms of resistance to shocks and vibrations, based on the technology used for larger-scale assemblies and fully integrating the 30° gradient into the interior thread (nut), making it easier to assemble the screw.

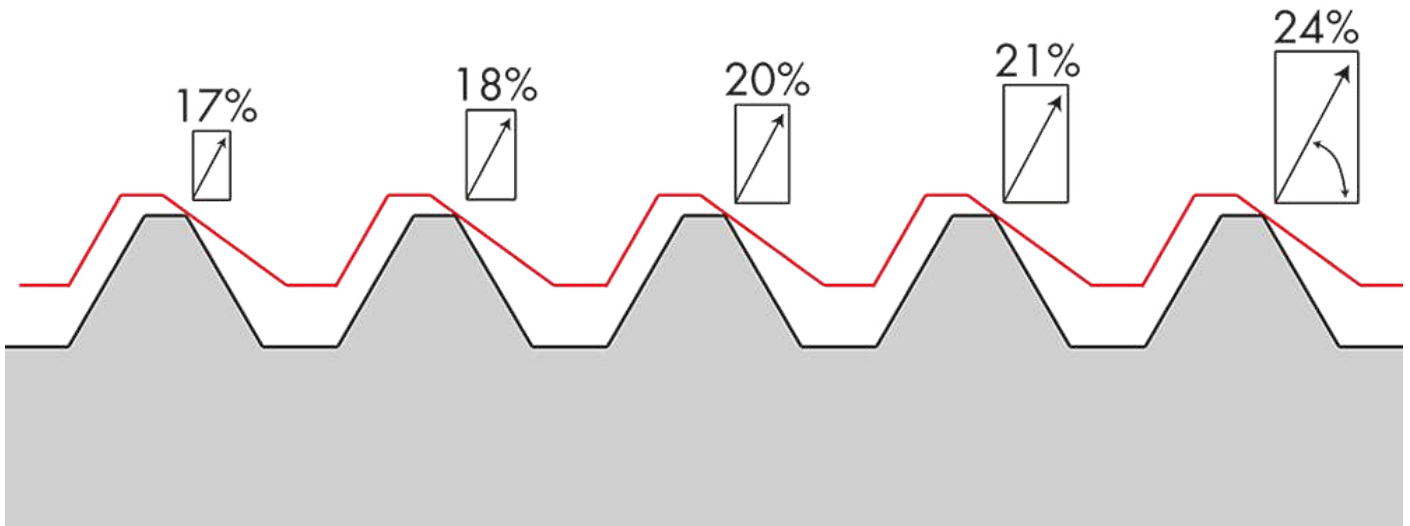

When tightening torque is applied, the tensile force exerted on the screw forces it to auto-centre, and the profile points of the screw come into contact with the edges of the asymmetrical profile of the interior screw thread (gradient), thus leading to tangential contact and a regular distribution of load across all the turns of the thread.

Reducing the load on the first few turns of the thread and directing the stress towards compressing the screw significantly reduces the fatigue experienced by the screw/nut assembly, thereby making it possible to assemble and disassemble it numerous times without changing its characteristics.

To correspond to the dimensional requirements, the core of the screw has been amply reinforced compared with a 60° NIHS or M type thread of the same dimension.

The length of the pitch has been reduced in comparison with the NIHS standard in order to increase the area of contact between the two fixing elements, with the usable length remaining the same. This obviously offers considerable advantages, particularly when working with soft materials and small-headed screws with a reduced thread length.

## THE ADVANTAGES OF THE SELF-LOCKING

- Distributes the tensile force along the entire length of the screw thread
- Nominal blocking torque up to 25 % less than that of a conventional assembly
- Completely mechanical, with no chemical additives

## THE ADVANTAGES OF THE SCREW

- Screw thread with tolerances tailored to meet requirements, enabling uninterrupted contact between screw and nut
- Fine pitch, increasing the surface in contact with the nut for the same length of thread
- Improved tensile strength thanks to an interior diameter of the profile that is 19 % greater (more than 40 % in section)
- Multiple assembly / disassembly with no change in mechanical properties

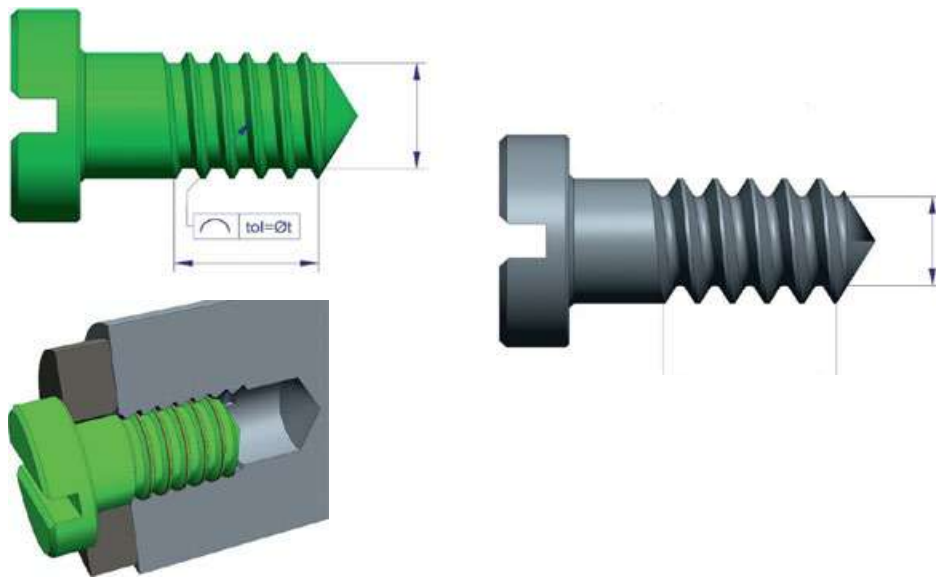

The numerous impact resistance tests that have been carried out, clearly show that the threaded assemblies are totally reliable and now offer a credible response to problems affecting screw resistance.

The tightening torques applied to specimen screws are 25 % less than the values recommended by manufacturers of chemical "threadlocking" coatings.

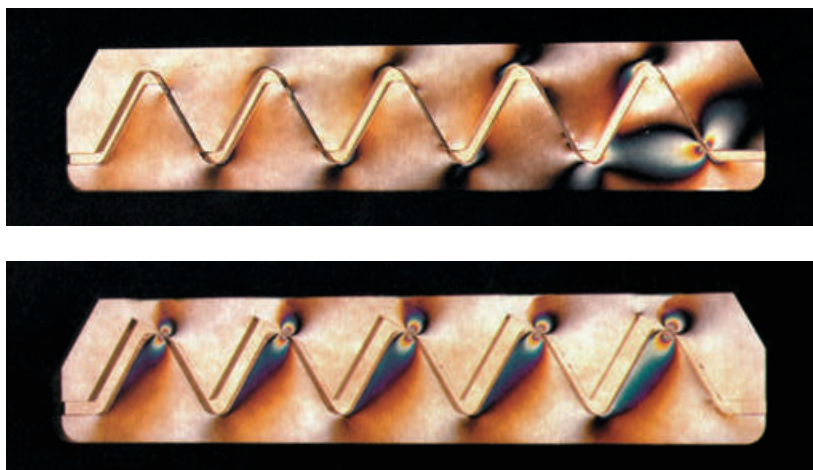



# SAFELOCK DIMENSIONS AND STANDARDS

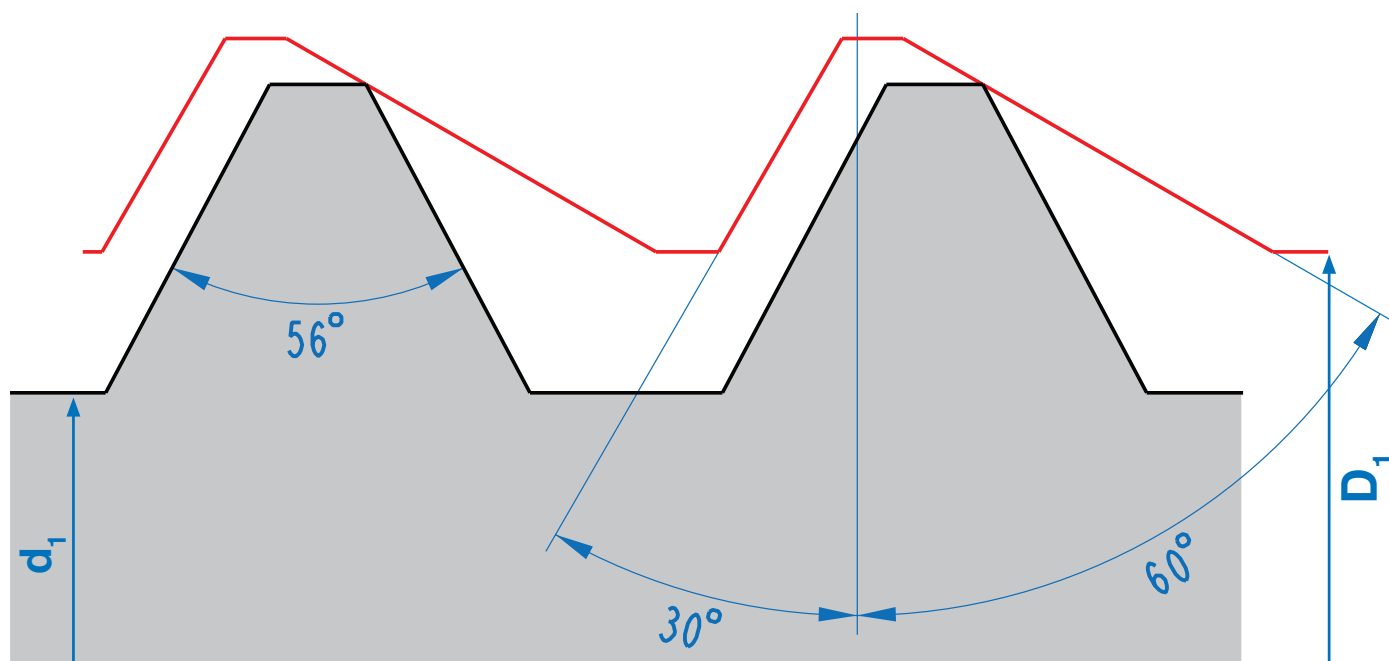

Dimension	Pitch mm	$d_1$ mini mm	$d_1$ maxi mm	Angles of sides of nut	Angles of sides of screw	$d_1$
SL 0.3	0.06	0.264	0.278	$30^\circ/60^\circ$	$56^\circ$	0.247
SL 0.35	0.06	0.314	0.328	$30^\circ/60^\circ$	$56^\circ$	0.297
SL 0.4	0.08	0.356	0.372	$30^\circ/60^\circ$	$56^\circ$	0.331
SL 0.5	0.1	0.448	0.466	$30^\circ/60^\circ$	$56^\circ$	0.416
SL 0.6	0.125	0.538	0.559	$30^\circ/60^\circ$	$56^\circ$	0.496
SL 0.7	0.15	0.628	0.651	$30^\circ/60^\circ$	$56^\circ$	0.576
SL 0.8	0.15	0.728	0.751	$30^\circ/60^\circ$	$56^\circ$	0.676
SL 0.9	0.175	0.818	0.844	$30^\circ/60^\circ$	$56^\circ$	0.756
SL 1.0	0.2	0.908	0.936	$30^\circ/60^\circ$	$56^\circ$	0.836
SL 1.2	0.2	1.108	1.136	$30^\circ/60^\circ$	$56^\circ$	1.036
SL 1.4	0.25	1.288	1.321	$30^\circ/60^\circ$	$56^\circ$	1.197

# TOLERANZEN FÜR M- UND MF-GEWINDE

## TOLERANCES FOR M AND MF THREADS

Muttergewinde  
Nut thread

Toleranz 6H  
 – Zahl = Genauigkeitsgrad  
 – Buchstabe = Toleranzlage  
 – Grossbuchstabe = Innengewinde

Tolerance 6H  
 – Number = degree of accuracy  
 – Letter = tolerance position  
 – Capital letter = internal thread

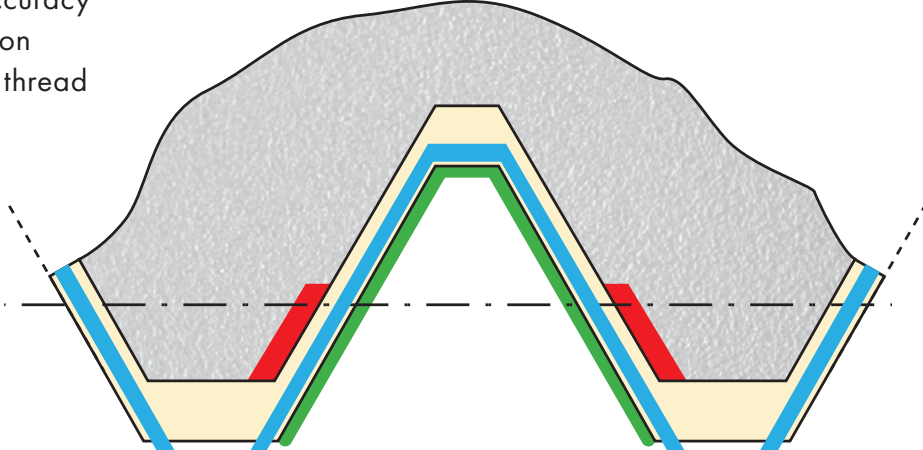

H/h=0

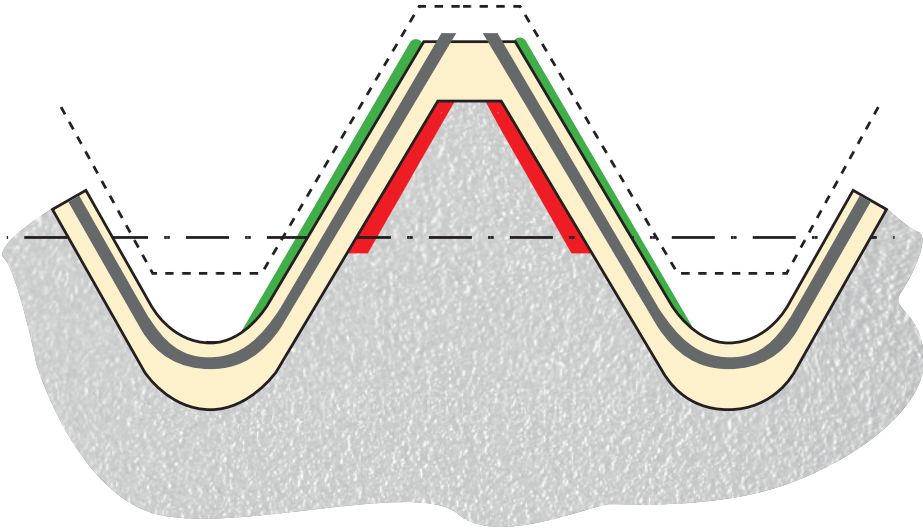

Bolzensgewinde  
Bolt thread

Toleranz 6g  
 – Zahl = Genauigkeitsgrad  
 – Kleinbuchstabe = Aussengewinde

Tolerance 6g  
 – Number = degree of accuracy  
 – Lowercase letter = external thread

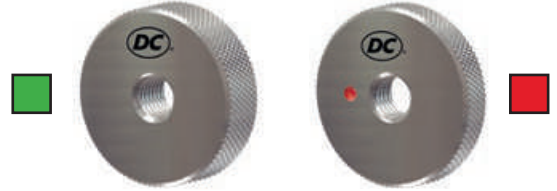

# TOLERANZEN FÜR M- UND MF-GEWINDE TOLERANCES FOR M AND MF THREADS

G = Übermass  
G = oversize

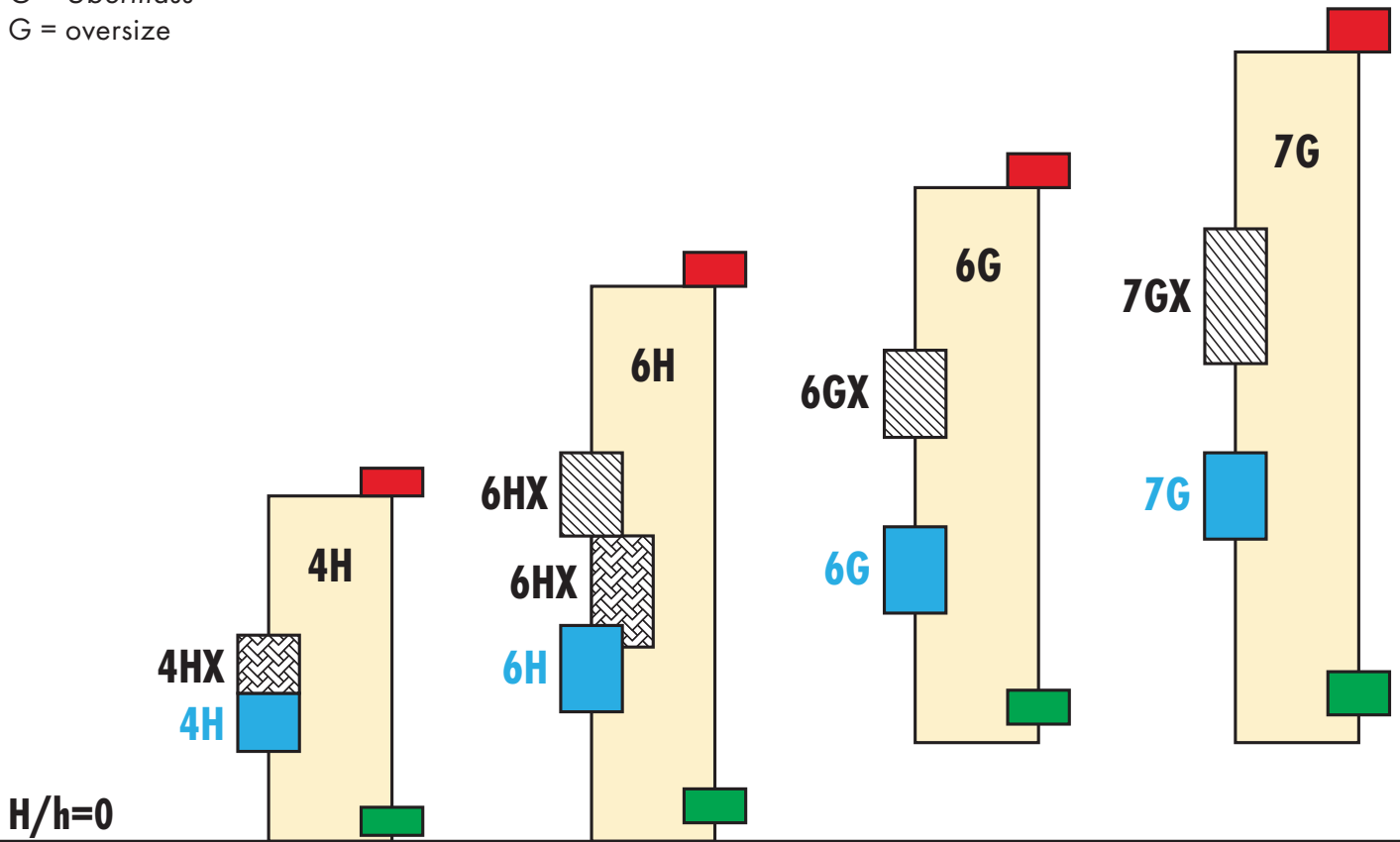

e = Untermass  
e = undersize

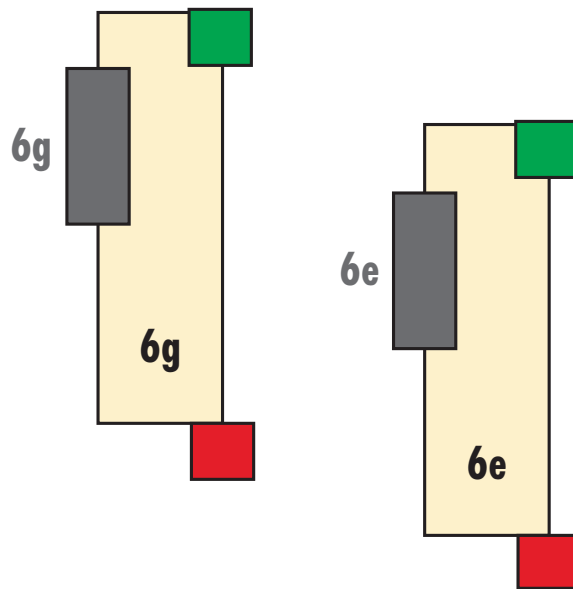

## TOLERANZBEZEICHNUNGEN NACH DIN EN 22857 FÜR GEWINDEBOHRER MIT METRISCHEM ISO-GEWINDE

Die Norm DIN 802, Teil 1, wurde zurückgezogen und durch die Norm DIN EN 22857 ersetzt.

In der nachfolgenden Tabelle ist in einer Gegenüberstellung die Norm DIN EN 22857 zu der zurückgezogenen Norm DIN 802, Teil 1, festgehalten. Eine wesentliche Änderung ist die Umstellung der Gewindebohrer-Toleranzklassen in die Bezeichnung der Gewindebohrer nach Anwendungsklassen.

Anwendungsklassen der Gewindebohrer nach DIN EN 22857		Toleranzklassen nach zurückgezogener Norm DIN 802, Teil 1	Zuordnung zu den Toleranzfeldern des zu schneidenden Muttergewindes				
Benennung	Kennzeichnung						
Klasse 1	<b>ISO 1</b>	4H	4H	5H	-	-	-
Klasse 2	<b>ISO 2</b>	6H	4G	5G	6H	-	-
Klasse 3	<b>ISO 3</b>	6G	-	-	6G	7H	8H
	-	7G	-	-	-	7G	8G

Für die Änderung ist mit einer entsprechenden Übergangszeit zu rechnen.

Die Kennzeichnungen der Toleranzklassen 7G / 8G und der "X"-Toleranzlagen sind in der Norm DIN EN 22857 noch nicht genormt und werden deshalb weiterhin unverändert nach der zurückgezogenen Norm DIN 802, Teil 1, vorgenommen.

## TOLERANCE NOTATIONS TO DIN EN 22857 FOR TAPS WITH METRIC ISO THREADS

The standard DIN 802, part 1, has been withdrawn and replaced by DIN EN 22857.

The following chart gives a comparison between the standard DIN EN 22857 and the withdrawn standard DIN 802, part 1. An important change is the re-classification from tap tolerance classes to tap application classes.

Application classes for taps to DIN EN 22857		Tolerance classes to withdrawn standard DIN 802, part 1	Allotment of the tolerance zones of the nut thread to be cut				
Name	Code						
Class 1	<b>ISO 1</b>	4H	4H	5H	-	-	-
Class 2	<b>ISO 2</b>	6H	4G	5G	6H	-	-
Class 3	<b>ISO 3</b>	6G	-	-	6G	7H	8H
-	-	7G	-	-	-	7G	8G

A suitable transition period is to be expected.

Codes for tolerance classes 7G / 8G and the "X" tolerance zones have not yet been standardised within DIN EN 22857 and the values from DIN 802 part 1 will continue to be valid.

# METRISCHES ISO-GEWINDE DIN 13

Nennmasse, Flankendurchmesser-Grenzmasse

Gewinde- Nennmasse	Steigung	Toleranz	Muttergewinde Flankendurchmesser		Toleranz	Bolzensgewinde Flankendurchmesser	
			min.	max.		max.	min.
M 1	(x0.25)	4H	0.838	0.883	6h	0.838	0.785
M 1.4	(x0.3)	4H	1.205	1.253	6h	1.205	1.149
M 1.6	(x0.35)	6H	1.373	1.458	6g	1.354	1.291
M 2	(x0.4)	6H	1.740	1.830	6g	1.721	1.654
M 2	x0.25	4H	1.838	1.886	6h	1.838	1.782
M 2.2	(x0.45)	6H	1.908	2.003	6g	1.888	1.817
M 2.5	(x0.45)	6H	2.208	2.303	6g	2.188	2.117
M 3	(x0.5)	6H	2.675	2.775	6g	2.655	2.580
M 3	x0.35	6H	2.773	2.863	6g	2.754	2.687
M 3.5	(x0.6)	6H	3.110	3.222	6g	3.089	3.004
M 4	(x0.7)	6H	3.545	3.663	6g	3.523	3.433
M 4	x0.5	6H	3.675	3.775	6g	3.655	3.580
M 4.5	(x0.75)	6H	4.013	4.131	6g	3.991	3.901
M 5	(x0.8)	6H	4.480	4.605	6g	4.456	4.361
M 6	(x1)	6H	5.350	5.500	6g	5.324	5.212
M 6	x0.75	6H	5.513	5.645	6g	5.491	5.391
M 6	x0.5	6H	5.675	5.787	6g	5.655	5.570
M 7	(x1)	6H	6.350	6.500	6g	6.324	6.212
M 8	(x1.25)	6H	7.188	7.348	6g	7.160	7.042
M 10	(x1.5)	6H	9.026	9.206	6g	8.994	8.862
M 12	(x1.75)	6H	10.863	11.063	6g	10.829	10.679
M 12	x1.5	6H	11.026	11.216	6g	10.994	10.854
M 12	x1.25	6H	11.188	11.368	6g	11.160	11.028
M 12	x1	6H	11.350	11.510	6g	11.324	11.206
M 12	x0.75	6H	11.513	11.653	6g	11.491	11.385
M 12	x0.5	6H	11.675	11.793	6g	11.655	11.565
M 14	(x2)	6H	12.701	12.913	6g	12.663	12.503
M 16	(x2)	6H	14.701	14.913	6g	14.663	14.503
M 18	(x2.5)	6H	16.376	16.600	6g	16.334	16.164
M 20	(x2.5)	6H	18.376	18.600	6g	18.334	18.164
M 22	(x2.5)	6H	20.376	20.600	6g	20.334	20.164
M 24	(x3)	6H	22.051	22.316	6g	22.003	21.803
M 24	x2	6H	22.701	22.925	6g	22.663	22.493
M 24	x1.5	6H	23.026	23.226	6g	22.994	22.844
M 24	x1	6H	23.350	23.520	6g	23.324	23.199
M 27	(x3)	6H	25.051	25.316	6g	25.003	24.803
M 30	(x3.5)	6H	27.727	28.007	6g	27.674	27.462
M 33	(x3.5)	6H	30.727	31.007	6g	30.674	30.462
M 36	(x4)	6H	33.402	33.702	6g	33.342	33.118
M 39	(x4)	6H	36.402	36.702	6g	36.342	36.118
M 42	(x4.5)	6H	39.077	39.392	6g	39.014	38.778
M 45	(x4.5)	6H	42.077	42.392	6g	42.014	41.778
M 48	(x5)	6H	44.752	45.087	6g	44.681	44.431
M 48	x4	6H	45.402	45.717	6g	45.342	45.106
M 48	x3	6H	46.051	46.331	6g	46.003	45.791
M 48	x2	6H	46.701	46.937	6g	46.663	46.483
M 48	1.5	6H	47.026	47.238	6g	46.994	46.834
M 48	x1	6H	47.350	47.530	6g	47.324	47.184
M 52	(x5)	6H	48.752	49.087	6g	48.681	48.431
M 56	(x5.5)	6H	52.428	52.783	6g	52.353	52.088
M 60	(x5.5)	6H	56.428	56.783	6g	56.353	56.088
M 64	(x6)	6H	60.103	60.478	6g	60.023	59.743
M 68	(x6)	6H	64.103	64.478	6g	64.023	63.743

## Andere Durchmesser-Steigungs-Kombinationen

Die Nenn- und Grenzwerte von anderen, in dieser Tabelle nicht aufgeführten metrischen ISO-Gewinden, können sehr leicht von einem oben aufgeführten Gewinde gleicher Steigung, durch Addition oder Subtraktion der Durchmesser-Differenz der Nennwerte, bestimmt werden; z.B. erhält man die Nenn- und Grenzwerte eines Gewindes MF11 x 0.5 aus denjenigen des Gewindes MF6 x 0.5, indem zu allen Nenn- und Grenzwerten 5 mm addiert werden. Diese Berechnungsregeln gelten allerdings nur innerhalb eines der nachstehenden Durchmesserbereiche:

über 0.99	bis 1.4 mm	über 5.6	bis 11.2 mm	über 45	bis 90 mm
über 1.4	bis 2.8 mm	über 11.2	bis 22.4 mm	über 90	bis 180 mm
über 2.8	bis 5.6 mm	über 22.4	bis 45.0 mm	über 180	bis 355 mm

# METRIC THREADS ISO DIN 13

Nominal thread diameters - Pitch diameters

Nominal thread diameters	Pitch	Tol.	Nut thread Pitch diameters		Tol.	Bolt thread Pitch diameters	
			mini	maxi		maxi	mini
			M 1	(x0.25)		4H	0.838
M 1.4	(x0.3)	4H	1.205	1.253	6h	1.205	1.149
M 1.6	(x0.35)	6H	1.373	1.458	6g	1.354	1.291
M 2	(x0.4)	6H	1.740	1.830	6g	1.721	1.654
M 2	x0.25	4H	1.838	1.886	6h	1.838	1.782
M 2.2	(x0.45)	6H	1.908	2.003	6g	1.888	1.817
M 2.5	(x0.45)	6H	2.208	2.303	6g	2.188	2.117
M 3	(x0.5)	6H	2.675	2.775	6g	2.655	2.580
M 3	x0.35	6H	2.773	2.863	6g	2.754	2.687
M 3.5	(x0.6)	6H	3.110	3.222	6g	3.089	3.004
M 4	(x0.7)	6H	3.545	3.663	6g	3.523	3.433
M 4	x0.5	6H	3.675	3.775	6g	3.655	3.580
M 4.5	(x0.75)	6H	4.013	4.131	6g	3.991	3.901
M 5	(x0.8)	6H	4.480	4.605	6g	4.456	4.361
M 6	(x1)	6H	5.350	5.500	6g	5.324	5.212
M 6	x0.75	6H	5.513	5.645	6g	5.491	5.391
M 6	x0.5	6H	5.675	5.787	6g	5.655	5.570
M 7	(x1)	6H	6.350	6.500	6g	6.324	6.212
M 8	(x1.25)	6H	7.188	7.348	6g	7.160	7.042
M 10	(x1.5)	6H	9.026	9.206	6g	8.994	8.862
M 12	(x1.75)	6H	10.863	11.063	6g	10.829	10.679
M 12	x1.5	6H	11.026	11.216	6g	10.994	10.854
M 12	x1.25	6H	11.188	11.368	6g	11.160	11.028
M 12	x1	6H	11.350	11.510	6g	11.324	11.206
M 12	x0.75	6H	11.513	11.653	6g	11.491	11.385
M 12	x0.5	6H	11.675	11.793	6g	11.655	11.565
M 14	(x2)	6H	12.701	12.913	6g	12.663	12.503
M 16	(x2)	6H	14.701	14.913	6g	14.663	14.503
M 18	(x2.5)	6H	16.376	16.600	6g	16.334	16.164
M 20	(x2.5)	6H	18.376	18.600	6g	18.334	18.164
M 22	(x2.5)	6H	20.376	20.600	6g	20.334	20.164
M 24	(x3)	6H	22.051	22.316	6g	22.003	21.803
M 24	x2	6H	22.701	22.925	6g	22.663	22.493
M 24	x1.5	6H	23.026	23.226	6g	22.994	22.844
M 24	x1	6H	23.350	23.520	6g	23.324	23.199
M 27	(x3)	6H	25.051	25.316	6g	25.003	24.803
M 30	(x3.5)	6H	27.727	28.007	6g	27.674	27.462
M 33	(x3.5)	6H	30.727	31.007	6g	30.674	30.462
M 36	(x4)	6H	33.402	33.702	6g	33.342	33.118
M 39	(x4)	6H	36.402	36.702	6g	36.342	36.118
M 42	(x4.5)	6H	39.077	39.392	6g	39.014	38.778
M 45	(x4.5)	6H	42.077	42.392	6g	42.014	41.778
M 48	(x5)	6H	44.752	45.087	6g	44.681	44.431
M 48	x4	6H	45.402	45.717	6g	45.342	45.106
M 48	x3	6H	46.051	46.331	6g	46.003	45.791
M 48	x2	6H	46.701	46.937	6g	46.663	46.483
M 48	1.5	6H	47.026	47.238	6g	46.994	46.834
M 48	x1	6H	47.350	47.530	6g	47.324	47.184
M 52	(x5)	6H	48.752	49.087	6g	48.681	48.431
M 56	(x5.5)	6H	52.428	52.783	6g	52.353	52.088
M 60	(x5.5)	6H	56.428	56.783	6g	56.353	56.088
M 64	(x6)	6H	60.103	60.478	6g	60.023	59.743
M 68	(x6)	6H	64.103	64.478	6g	64.023	63.743

## Other diameter/pitch combinations

The nominal and tolerance values of other metric ISO threads not listed in this chart can easily be established for threads of the same pitch by the addition or subtraction of the difference in the nominal diameter: E.G. the nominal and tolerance values for an MF11 x 0.5 thread are obtained by simply adding 5 mm to the values for the thread MF6 x 0.5. However, this rule only applies within the following diameter ranges:

over 0.99	to 1.4 mm	over 5.6	to 11.2 mm	over 45	to 90 mm
over 1.4	to 2.8 mm	over 11.2	to 22.4 mm	over 90	to 180 mm
over 2.8	to 5.6 mm	over 22.4	to 45.0 mm	over 180	to 355 mm

# METRISCHES ISO-GEWINDE

## Flankendurchmesser-Toleranzen für Gewindebohrer

Gewinde Nenn-Ø (Aussen-Ø)		Gewinde-Steigung P	Toleranzklasse	Unteres Abmass		Oberes Abmass		Gewinde Nenn-Ø (Aussen-Ø)		Gewinde-Steigung P	Toleranzklasse	Unteres Abmass		Oberes Abmass											
über	bis						über	bis																	
0.99	1.4	0.2	ISO 1 / 4H	+ 5	+ 15	11.2	22.4	2.5	ISO 1 / 4H	+ 18	+ 54	ISO 1 / 4H	+ 18	+ 54	ISO 2 / 6H	+ 54	+ 90								
			ISO 1 / 4H	+ 6	+ 17				ISO 2 / 6H	+ 54	+ 90		ISO 3 / 6G	+ 90		+ 126									
			ISO 1 / 4H	+ 6	+ 18				ISO 3 / 6G	+ 90	+ 126		7G	+ 126		+ 162									
			ISO 2 / 6H	+ 18	+ 30				7G	+ 126	+ 162														
1.4	2.8	0.2	ISO 1 / 4H	+ 5	+ 15	22.4	45	1	ISO 1 / 4H	+ 13	+ 40	ISO 1 / 4H	+ 13	+ 40	ISO 2 / 6H	+ 40	+ 66								
			ISO 1 / 4H	+ 6	+ 18				ISO 2 / 6H	+ 40	+ 66		ISO 3 / 6G	+ 66		+ 92									
			ISO 1 / 4H	+ 7	+ 20				ISO 3 / 6G	+ 66	+ 92		7G	+ 92		+ 118									
			ISO 2 / 6H	+ 20	+ 34				7G	+ 92	+ 118		1.5	ISO 1 / 4H		+ 16	+ 48								
			ISO 1 / 4H	+ 7	+ 21				ISO 1 / 4H	+ 16	+ 48			ISO 2 / 6H		+ 48	+ 80								
			ISO 2 / 6H	+ 21	+ 36				ISO 2 / 6H	+ 48	+ 80			ISO 3 / 6G		+ 80	+ 112								
2.8	5.6	0.35	ISO 1 / 4H	+ 7	+ 21	2.8	5.6	0.35	ISO 1 / 4H	+ 7	+ 21	ISO 1 / 4H	+ 18	+ 54	ISO 2 / 6H	+ 54	+ 90								
			ISO 2 / 6H	+ 21	+ 36				ISO 2 / 6H	+ 21	+ 36		ISO 3 / 6G	+ 90		+ 126									
			ISO 1 / 4H	+ 8	+ 24				ISO 3 / 6G	+ 90	+ 126		7G	+ 126		+ 162									
			ISO 2 / 6H	+ 24	+ 40				7G	+ 126	+ 162		3	ISO 1 / 4H		+ 21	+ 64								
			ISO 3 / 6G	+ 40	+ 55				ISO 1 / 4H	+ 21	+ 64			ISO 2 / 6H		+ 64	+ 106								
			7G	+ 55	+ 70				ISO 2 / 6H	+ 64	+ 106			ISO 3 / 6G		+ 106	+ 148								
5.6	11.2	1	ISO 1 / 4H	+ 9	+ 27	5.6	11.2	1	ISO 1 / 4H	+ 9	+ 27	ISO 1 / 4H	+ 22	+ 67	ISO 2 / 6H	+ 67	+ 112								
			ISO 2 / 6H	+ 27	+ 45				ISO 2 / 6H	+ 27	+ 45		ISO 3 / 6G	+ 112		+ 157									
			ISO 3 / 6G	+ 45	+ 63				ISO 3 / 6G	+ 45	+ 63		7G	+ 157		+ 202									
			7G	+ 63	+ 81				7G	+ 63	+ 81		4	ISO 1 / 4H		+ 24	+ 71								
			ISO 1 / 4H	+ 10	+ 29				ISO 1 / 4H	+ 24	+ 71			ISO 2 / 6H		+ 71	+ 118								
			ISO 2 / 6H	+ 29	+ 48				ISO 2 / 6H	+ 71	+ 118			ISO 3 / 6G		+ 118	+ 165								
11.2	22.4	1	ISO 3 / 6G	+ 48	+ 67	11.2	22.4	1	ISO 3 / 6G	+ 48	+ 67	ISO 3 / 6G	+ 165	+ 212	7G	+ 165	+ 212								
			7G	+ 67	+ 86				7G	+ 165	+ 212		4.5	ISO 1 / 4H		+ 25	+ 75								
			ISO 1 / 4H	+ 10	+ 29				ISO 1 / 4H	+ 25	+ 75			ISO 2 / 6H		+ 75	+ 125								
			ISO 2 / 6H	+ 29	+ 48				ISO 2 / 6H	+ 75	+ 125			ISO 3 / 6G		+ 125	+ 175								
			5.6	11.2	1				ISO 3 / 6G	+ 48	+ 67		5.6	11.2		1	ISO 3 / 6G	+ 48	+ 67	ISO 3 / 6G	+ 175	+ 225	7G	+ 175	+ 225
									7G	+ 67	+ 86						7G	+ 175	+ 225		45	ISO 1 / 4H		+ 17	+ 51
ISO 1 / 4H	+ 12	+ 35				ISO 1 / 4H	+ 17	+ 51	ISO 2 / 6H	+ 51	+ 85														
ISO 2 / 6H	+ 35	+ 59				ISO 2 / 6H	+ 51	+ 85	ISO 3 / 6G	+ 85	+ 119														
11.2	22.4	1				ISO 3 / 6G	+ 59	+ 83	11.2	22.4	1	ISO 3 / 6G			+ 59		+ 83	ISO 3 / 6G	+ 119		+ 153	7G		+ 119	+ 153
						7G	+ 83	+ 107				7G			+ 119		+ 153		2		ISO 1 / 4H			+ 19	+ 57
			ISO 1 / 4H	+ 13	+ 38	ISO 1 / 4H	+ 19	+ 57				ISO 2 / 6H	+ 57	+ 95											
			ISO 2 / 6H	+ 38	+ 63	ISO 2 / 6H	+ 57	+ 95				ISO 3 / 6G	+ 95	+ 133											
			11.2	22.4	1	ISO 3 / 6G	+ 63	+ 88				11.2	22.4	1	ISO 3 / 6G	+ 63	+ 88		ISO 3 / 6G	+ 133	+ 171		7G	+ 133	+ 171
						7G	+ 88	+ 113							7G	+ 133	+ 171			3	ISO 1 / 4H			+ 22	+ 67
ISO 1 / 4H	+ 14	+ 42				ISO 1 / 4H	+ 22	+ 67	ISO 2 / 6H	+ 67	+ 112														
ISO 2 / 6H	+ 42	+ 70				ISO 2 / 6H	+ 67	+ 112	ISO 3 / 6G	+ 112	+ 157														
11.2	22.4	1				ISO 3 / 6G	+ 63	+ 88	11.2	22.4	1				ISO 3 / 6G	+ 63	+ 88	ISO 3 / 6G		+ 157	+ 202	7G		+ 157	+ 202
						7G	+ 88	+ 113							7G	+ 157	+ 202			4	ISO 1 / 4H			+ 25	+ 75
			ISO 1 / 4H	+ 14	+ 42	ISO 1 / 4H	+ 25	+ 75				ISO 2 / 6H	+ 75	+ 125											
			ISO 2 / 6H	+ 42	+ 70	ISO 2 / 6H	+ 75	+ 125				ISO 3 / 6G	+ 125	+ 175											
			11.2	22.4	1	ISO 3 / 6G	+ 70	+ 98				11.2	22.4	1	ISO 3 / 6G	+ 70	+ 98		ISO 3 / 6G	+ 175	+ 225		7G	+ 175	+ 225
						7G	+ 98	+ 126							7G	+ 175	+ 225			5	ISO 1 / 4H			+ 27	+ 80
ISO 1 / 4H	+ 15	+ 45				ISO 1 / 4H	+ 27	+ 80	ISO 2 / 6H	+ 80	+ 133														
ISO 2 / 6H	+ 45	+ 75				ISO 2 / 6H	+ 80	+ 133	ISO 3 / 6G	+ 133	+ 186														
11.2	22.4	1				ISO 3 / 6G	+ 75	+ 105	11.2	22.4	1				ISO 3 / 6G	+ 75	+ 105	ISO 3 / 6G		+ 186	+ 239	7G		+ 186	+ 239
						7G	+ 105	+ 135							7G	+ 186	+ 239			5.5	ISO 1 / 4H			+ 28	+ 84
			ISO 1 / 4H	+ 16	+ 48	ISO 1 / 4H	+ 28	+ 84				ISO 2 / 6H	+ 84	+ 140											
			ISO 2 / 6H	+ 48	+ 80	ISO 2 / 6H	+ 84	+ 140				ISO 3 / 6G	+ 140	+ 196											
			11.2	22.4	1	ISO 3 / 6G	+ 80	+ 112				11.2	22.4	1	ISO 3 / 6G	+ 80	+ 112		ISO 3 / 6G	+ 196	+ 252		7G	+ 196	+ 252
						7G	+ 112	+ 144							7G	+ 196	+ 252			6	ISO 1 / 4H			+ 30	+ 90
ISO 1 / 4H	+ 17	+ 51				ISO 1 / 4H	+ 30	+ 90	ISO 2 / 6H	+ 90	+ 150														
ISO 2 / 6H	+ 51	+ 85				ISO 2 / 6H	+ 90	+ 150	ISO 3 / 6G	+ 150	+ 210														
11.2	22.4	1				ISO 3 / 6G	+ 85	+ 119	11.2	22.4	1				ISO 3 / 6G	+ 85	+ 119	ISO 3 / 6G		+ 210	+ 270	7G		+ 210	+ 270
						7G	+ 119	+ 153							7G	+ 210	+ 270								



# METRIC ISO THREADS

## Pitch diameter tolerances for taps

Nominal thread Ø		Pitch	Tolerance classes	Lower limit	Upper limit	Nominal thread Ø		Pitch	Tolerance classes	Lower limit	Upper limit		
over	to	P				over	to	P					
0.99	1.4	0.2	ISO 1 / 4H	+ 5	+ 15	11.2	22.4	2.5	ISO 1 / 4H	+ 18	+ 54		
		0.25	ISO 1 / 4H	+ 6	+ 17				ISO 2 / 6H	+ 54	+ 90		
		0.3	ISO 1 / 4H	+ 6	+ 18				ISO 3 / 6G	+ 90	+ 126		
1.4	2.8	0.2	ISO 1 / 4H	+ 5	+ 15			22.4	45	1	7G	+ 126	+ 162
		0.25	ISO 1 / 4H	+ 6	+ 18						ISO 1 / 4H	+ 13	+ 40
		0.35	ISO 1 / 4H	+ 7	+ 20						ISO 2 / 6H	+ 40	+ 66
		0.4	ISO 2 / 6H	+ 20	+ 34					ISO 3 / 6G	+ 66	+ 92	
			ISO 1 / 4H	+ 7	+ 21					7G	+ 92	+ 118	
			ISO 2 / 6H	+ 21	+ 36					1.5	ISO 1 / 4H	+ 16	+ 48
0.45	ISO 1 / 4H	+ 8	+ 23	ISO 2 / 6H	+ 48			+ 80					
	ISO 2 / 6H	+ 23	+ 38	ISO 3 / 6G	+ 80			+ 112					
2.8	5.6	0.35	ISO 1 / 4H	+ 7	+ 21			2	90	2	7G	+ 112	+ 144
			ISO 2 / 6H	+ 21	+ 36	ISO 1 / 4H	+ 18				+ 54		
		0.5	ISO 1 / 4H	+ 8	+ 24	ISO 2 / 6H	+ 54			+ 90			
			ISO 2 / 6H	+ 24	+ 40	ISO 3 / 6G	+ 90			+ 126			
			ISO 3 / 6G	+ 40	+ 55	7G	+ 126			+ 162			
		0.6	7G	+ 55	+ 70	3	ISO 1 / 4H			+ 21	+ 64		
			ISO 1 / 4H	+ 9	+ 27		ISO 2 / 6H			+ 64	+ 106		
			ISO 2 / 6H	+ 27	+ 45		ISO 3 / 6G			+ 106	+ 148		
		0.7	ISO 3 / 6G	+ 45	+ 63	3.5	7G			+ 148	+ 190		
			7G	+ 63	+ 81		ISO 1 / 4H			+ 22	+ 67		
			ISO 1 / 4H	+ 10	+ 29		ISO 2 / 6H			+ 67	+ 112		
		0.75	ISO 2 / 6H	+ 29	+ 48	ISO 3 / 6G	+ 112			+ 157			
ISO 3 / 6G	+ 48		+ 67	7G	+ 157		+ 202						
0.8	7G	+ 67	+ 86	4	ISO 1 / 4H	+ 24	+ 71						
		ISO 1 / 4H	+ 10		+ 30	ISO 2 / 6H	+ 71	+ 118					
		ISO 2 / 6H	+ 30		+ 50	ISO 3 / 6G	+ 118	+ 165					
		ISO 3 / 6G	+ 50		+ 70	7G	+ 165	+ 212					
5.6	11.2	1	7G	+ 70	+ 90	4.5	90	4.5	ISO 1 / 4H	+ 25	+ 75		
			ISO 1 / 4H	+ 12	+ 35				ISO 2 / 6H	+ 75	+ 125		
			ISO 2 / 6H	+ 35	+ 59				ISO 3 / 6G	+ 125	+ 175		
			ISO 3 / 6G	+ 59	+ 83				7G	+ 175	+ 225		
		1.25	7G	+ 83	+ 107			1.5	ISO 1 / 4H	+ 17	+ 51		
			ISO 1 / 4H	+ 13	+ 38				ISO 2 / 6H	+ 51	+ 85		
			ISO 2 / 6H	+ 38	+ 63				ISO 3 / 6G	+ 85	+ 119		
			ISO 3 / 6G	+ 63	+ 88				7G	+ 119	+ 153		
		1.5	7G	+ 88	+ 113			2	ISO 1 / 4H	+ 19	+ 57		
			ISO 1 / 4H	+ 14	+ 42				ISO 2 / 6H	+ 57	+ 95		
			ISO 2 / 6H	+ 42	+ 70				ISO 3 / 6G	+ 95	+ 133		
			ISO 3 / 6G	+ 70	+ 98				7G	+ 133	+ 171		
11.2	22.4	1	7G	+ 98	+ 126	3	90	3	ISO 1 / 4H	+ 22	+ 67		
			ISO 1 / 4H	+ 13	+ 38				ISO 2 / 6H	+ 67	+ 112		
			ISO 2 / 6H	+ 38	+ 63				ISO 3 / 6G	+ 112	+ 157		
			ISO 3 / 6G	+ 63	+ 88				7G	+ 157	+ 202		
		1.25	7G	+ 88	+ 113			4	ISO 1 / 4H	+ 25	+ 75		
			ISO 1 / 4H	+ 14	+ 42				ISO 2 / 6H	+ 75	+ 125		
			ISO 2 / 6H	+ 42	+ 70				ISO 3 / 6G	+ 125	+ 175		
			ISO 3 / 6G	+ 70	+ 98				7G	+ 175	+ 225		
		1.5	7G	+ 98	+ 126			5	ISO 1 / 4H	+ 27	+ 80		
			ISO 1 / 4H	+ 15	+ 45				ISO 2 / 6H	+ 80	+ 133		
			ISO 2 / 6H	+ 45	+ 75				ISO 3 / 6G	+ 133	+ 186		
			ISO 3 / 6G	+ 75	+ 105				7G	+ 186	+ 239		
1.75	7G	+ 105	+ 135	5.5	ISO 1 / 4H	+ 28	+ 84						
	ISO 1 / 4H	+ 16	+ 48		ISO 2 / 6H	+ 84	+ 140						
	ISO 2 / 6H	+ 48	+ 80		ISO 3 / 6G	+ 140	+ 196						
	ISO 3 / 6G	+ 80	+ 112		7G	+ 196	+ 252						
2	7G	+ 112	+ 144	6	ISO 1 / 4H	+ 30	+ 90						
	ISO 1 / 4H	+ 17	+ 51		ISO 2 / 6H	+ 90	+ 150						
	ISO 2 / 6H	+ 51	+ 85		ISO 3 / 6G	+ 150	+ 210						
	ISO 3 / 6G	+ 85	+ 119		7G	+ 210	+ 270						
7G	+ 119	+ 153											



# INTERESSANTE HINWEISE ZUM GEWINDESCHNEIDEN

Optimale Einsatzbedingungen reduzieren die effektiven Arbeitszeiten und erhöhen die Lebensdauer der Gewindebohrer.

**Wahl des bestgeeigneten Gewindebohrers** Welcher Gewindebohrer-Typ, oder ob Gewindeformer eingesetzt werden können, hängt von der Art des zu bearbeitenden Werkstoffes ab.

Allgemein gilt als Richtlinie, dass sich Werkstoffe mit einer Bruchdehnung von mindestens 10 % kalt verformen lassen.

Zur Bestimmung des bestgeeigneten Gewindebohrers dienen Ihnen die DC-Anwendungstabellen.

**Kernlochbohrungen**

- Die Kernlochbohrungen sollten sauber und die Bohrspäne entfernt sein.
- Die Kernlochdurchmesser sind nach Norm, Auszug in diesem Katalog im technischen Teil, und je nach Arbeitsfall im oberen Grenzbereich, zu bestimmen.

**Schmiermittel in Bezug auf Bearbeitungszentren** Oft erweisen sich die auf Bearbeitungszentren verwendeten Kühlmittel für das Gewindeschneiden als ungenügend, weil die Schmierfähigkeit zu niedrig ist. Wenn es nicht möglich ist, die Schmierfähigkeit der Emulsion zu erhöhen, kann das Schmierproblem oft auf anderem Weg gelöst werden, z.B.:

### Schmiermittel mit dem Konzentrat der Emulsion

- Der Maschinensteuerung angeschlossen, schießt ein Schmiergerät, zum gewollten Zeitpunkt, eine bestimmte Menge Schmierkonzentrat ins Gewinde-Kernloch oder an den Gewindebohrer.
- Aus separatem Behälter, gesteuert durch die Maschine, befördert eine Pumpe die bestimmte Menge Konzentrat zum Gewinde-Kernloch.

### Gewindeschneiden in Nacharbeit

Dieses Vorgehen ermöglicht es, das ideale Schmiermittel zu verwenden.

**Schnittgeschwindigkeiten für Gewindebohrer** Die Schnittgeschwindigkeit hat einen grossen Einfluss auf die Spanabfuhr und die Lebensdauer der Gewindebohrer. Es lohnt sich deshalb, die ideale Schnittgeschwindigkeit durch Schneidversuche zu ermitteln; Richtwerte siehe DC-Anwendungstabellen.

Die Schnittgeschwindigkeit sollte den Charakteristiken des Werkstoffes, der Maschine, sowie deren Ausrüstung entsprechen.

### Auswirkungen von nicht angepasster Schnittgeschwindigkeit:

- Aufbauschneiden
- Ausbrüche am Anschnitt infolge Überlastung der Schneidzähne
- aufgerissene Gewinde
- ungenügende Standzeit der Gewindebohrer
- Ausschuss-Gewinde

## INTERESSANTE HINWEISE ZUM GEWINDESCHNEIDEN

### **Kaltschweissungen**

*Aus welchen Gründen entstehen Kaltschweissungen?*

- Zu hohe oder zu niedrige Drehzahl
- Nicht geeigneter Gewindebohrer-Typ
- Gewindebohrer mit unpassender Schneidengeometrie
- Schmiermittel, nicht dem Werkstoff entsprechend
- Schmiermittel, Menge ungenügend
- Axial-Druck oder Zug auf Gewindebohrer
- Kernloch zu klein
- Aufgerissene Kernloch-Wandungen
- Bohrspäne in der Bohrung
- Zentrierfehler
- Rundlauffehler

*Auswirkungen der Kaltschweissungen:*

- aufgerissene Gewinde
- ungenügende Standzeiten der Gewindebohrer
- Ausschussgewinde
- Werkzeugbruch
- Ausschuss-Werkstücke

### **Gewindebohrer- Aufspannung**

- Der Gewindebohrer ist axial zum Kernloch einzuspannen.
- Bei nicht vollsynchronisierten Maschinen (Interpolation - Vorschub/Drehzahl) empfehlen wir den Einsatz eines Gewindeschneidfutters (Gewindeschneidspindel).

### **Aufnahme-Futter für Gewindebohrer**

*Bei nicht vollsynchronisierter Maschinenspindel (Vorschub/Umdrehungen) ist der Vorschub in der Regel ca. 5 - 10 % kleiner zu programmieren als die Gewindesteigung. In diesen Fällen ist ein Gewindeschneidfutter zu verwenden, bei dem es möglich ist, den Unterschied zwischen dem Vorschub und der Steigung zu kompensieren.*

*Wichtig ist, dass die Zugfeder des Längenausgleichs leichtgängig eingestellt ist, um den Gewindebohrer nicht mit axialem Zug zu belasten.*

*Die Andruckfeder hingegen ist so stark zu spannen, dass der Gewindebohrer anschneidet, ohne diese zu komprimieren, oder bis höchstens um den Wert der halben Steigung.*

#### **Wichtige Hinweise:**

*Eine gute Stabilität von Maschine und Aufnahme sind Voraussetzung für eine optimale Qualität und Leistung.*

*Stellen Sie sicher, dass die richtige Schnittgeschwindigkeit gewählt ist.*

*Achten Sie darauf, dass beim Gewindeschneiden reichlich Schmiermittel verwendet wird.*

# INTERESTING HINTS FOR TAPPING

Optimum tapping conditions reduce effective machining times and increase tap life.

## **Selection of the most suitable tap**

Which types of tap or whether or not a thread former can be used, depends on the type of material to be machined.

As a general guide, materials with an extension of at least 10 % can be cold-formed.

To determine the most suitable tap, refer to the DC application charts.

## **Core holes**

—Core holes should be clean and swarf-free.

—Core holes should be of the prescribed size, see chart extract in the technical part of this catalogue, and dependent on the actual application, selected towards the upper diameter limit.

## **Lubricant in relation to machining centers**

Frequently the coolants used on machining centers are insufficient for tapping because their percentage lubricant content is too low. If it is not possible to increase the percentage of lubricant in the emulsion, the lubrication problem can be solved in other ways, i.e.:

### **Lubricating with concentrated emulsion**

- A. A lubricating unit, connected to the machine control, delivers at the required instant a specific quantity of concentrated emulsion into the core hole or onto the tap.
- B. A pump in a separate tank, controlled by the machine, delivers a specific quantity of concentrate into the core hole.

### **Tapping in separate operations**

This procedure allows the use of the ideal tapping lubricant.

## **Cutting speeds for taps**

The cutting speed has a great influence on chip flow and the life time of the tap. It is therefore worthwhile to establish the ideal cutting speed by tapping trials. Guide values see on the DC application charts.

The cutting speed should be in relation to the characteristics of the material to be performed, the machine and its equipment.

### **Effects of unsuitable cutting speeds**

- forced tapping
- tap lead chipping caused by overloaded cutting tooth
- torn threads
- unsatisfactory tap life
- rejected threads

# INTERESTING HINTS FOR TAPPING

## **Cold welding**

What are the causes of cold welding?

- Cutting speed too high or too low
- Unsuitable tap selection
- Tap with non-adapted cutting geometry
- Coolant unsuitable for material
- Insufficient coolant
- Axial pressure (pull or push) on the tap
- Core hole too small
- Torn core hole walls
- Drill chips in the hole
- Centering error
- Concentricity error

Effects of cold welding:

- torn threads
- short tap life
- rejected threads
- tool breakage
- scrap workpieces

## **Tap fitting**

- The tap must be clamped axially to the core hole.
- On non-synchronized machines (feed/speed), we recommend the use of a tapping spindle.

## **Tapping heads**

With non-synchronized machine spindles (feed/speed) the feed rate should, as a rule, be programmed approx. 5 - 10 % lower than the thread pitch. In these cases a tapping chuck must be used which will compensate the difference between the feed rate and the thread pitch.

It is important that the tension spring in the axial compensation is set to a light rate to avoid axially loading the tap.

The compression spring, on the other hand, should be tensioned so that the tap starts to cut by compressing the spring at the most up to one half pitch.

### **Important hints:**

A good stability of machine and equipment is a prerequisite for optimum quality and performance.

Ensure that the correct cutting speed is selected.

Make sure that ample lubricating coolant is used when tapping.

## GEWINDEBOHRER-EINSATZ, ANWENDUNG-TIPPS

Problem	Ursachen	Abhilfe durch
<b>Zahnausbrüche am Gewindebohrer</b>	Spanstau	Schnittgeschwindigkeit überprüfen. Anderen Gewindebohrer-Typen einsetzen (K / N.62.-3 / Z.70VS).
	Gewindebohrer ist auf den Grund des Kernloches aufgestossen	Kernloch- und Gewindetiefe kontrollieren. Kernloch tiefer bohren.
	Unregelmässige Struktur des Werkstoffes	Schnittgeschwindigkeit anpassen. Schmierfähigkeit des Kühlschmiermittels verbessern. Gewindebohrer mit anderer Schneidengeometrie / Beschichtung einsetzen.
	Gewindebohrer falsch nachgeschliffen (Anschnittdurchmesser zu klein, deshalb zu wenig arbeitende Zähne)	Beim Nachschleifen darauf achten, dass die gleichen Werte wie bei neuen Werkzeugen angewendet werden.

Problem	Ursachen	Abhilfe durch
<b>Übermässige Abnutzung</b>	Falsche Schnittgeschwindigkeit	Schnittgeschwindigkeit dem zu bearbeitenden Werkstoff anpassen. Gewindebohrer mit empfohlener Beschichtung einsetzen.
	Kühlschmiermittel ungenügend in Bezug auf Schmierfähigkeit und / oder Zufuhr	Kühlschmierung verbessern. Dafür sorgen, dass das Kühlschmiermittel ausreichend bis an die Anschnittzone des Gewindebohrers geführt wird.
	Oberfläche des Kernloches ist verdichtet	Einsatzbedingungen für Kernlochbohrungen überprüfen (sorgfältig bohren, damit sich der Werkstoff so wenig wie möglich verfestigt). Schneidkanten des Spiralbohrers kontrollieren.
	Synchronisierung	Synchronisierungsstatus prüfen. Starres Gewindeschneiden in Materialien mit hohen mechanischen Eigenschaften vermeiden.

Problem	Ursachen	Abhilfe durch
<b>Gewindebohrerbruch</b>	Falscher Gewindebohrer im Einsatz (Schneidengeometrie ist für Arbeitsfall ungeeignet)	Gewindebohrer für die zu zerspanende Werkstoffgruppe einsetzen.
	Schlechter Spanabfluss	Geometrie der zu schneidenden Gewindetiefe anpassen. Wenn nötig, Nutenlänge anpassen.
	Zentrierfehler	Dafür sorgen, dass der Gewindebohrer axial zum Kernloch eingespannt wird.
	Gewindebohrer ist stumpf	Gewindebohrer nachschleifen. Darauf achten, dass Gewindebohrer sorgfältig gelagert werden.
	Gewindebohrer ist auf den Kernlochgrund aufgestossen	Gewindeschneidspindel mit Längenausgleich und Drehmoment-Überlastungskupplung einsetzen (nicht geeignet für CNC-Maschinen).
	Kernlochbohrung zu klein	Kernlochdurchmesser nach Tabelle im technischen Teil dieses Kataloges wählen.

## GEWINDEBOHRER-EINSATZ, ANWENDUNG-TIPPS

Problem	Ursachen	Abhilfe durch
<b>Gewinde zu gross</b>	Falscher Gewindebohrer-Typ im Einsatz (Schneidengeometrie ist für den Arbeitsfall ungeeignet)	Gewindebohrer für die zu zerspanende Werkstoffgruppe einsetzen.
	Schlechte Zentrierung	Sich vergewissern, dass Gewindebohrer und Kernloch axial zueinander verlaufen.
	Kaltschweissungen	Schmierfähigkeit und Zufuhr des Kühlschmiermittels verbessern. Schnittgeschwindigkeit anpassen. Gewindebohrer mit empfohlener Oberflächenbehandlung oder Beschichtung einsetzen.
	Nachgeschliffene Gewindebohrer (Anschnitt ist nicht konzentrisch)	Gewindebohrer auf Anschnitt-Schleifmaschine nochmals korrekt nachschleifen.

Problem	Ursachen	Abhilfe durch
<b>Gewinde verschnitten</b>	Falscher Gewindebohrer im Einsatz (Schneidengeometrie ist für den Arbeitsfall ungeeignet)	Gewindebohrer für die zu zerspanende Werkstoffgruppe einsetzen.
	Umdrehungen der Spindel stimmen nicht mit Vorschub überein	Programmierung bzw. Steigung der Leitspindel kontrollieren. Einsatz einer Gewindeschneidspindel mit Längenausgleich oder Synchron-Gewindeschneidfutter mit Axial-Stossdämpfer.
	Synchronisierung	Synchronisierungsstatus prüfen. Starres Gewindeschneiden in Materialien mit hohen mechanischen Eigenschaften vermeiden.
	Gewindebohrer mit Schälanschnitt wird mit zu geringem Anschnittdruck eingesetzt	Stärkeres Andrücken beim Anschneiden.

Problem	Ursachen	Abhilfe durch
<b>Gewinde mit Vorweite</b>	Das Gewinde wurde mit falschem Anschnittdruck geschnitten	Gewindeschneidspindel mit Längenausgleich einsetzen.

Problem	Ursachen	Abhilfe durch
<b>Unsaubere Gewindeoberfläche</b>	Falscher Gewindebohrer im Einsatz (Schneidengeometrie ist für Arbeitsfall ungeeignet)	Gewindebohrer für die zu zerspanende Werkstoffgruppe einsetzen.
	Gewindebohrer ist stumpf	Gewindebohrer auswechseln oder nachschleifen.
	Gewindebohrer falsch nachgeschliffen	Gewindebohrer nochmals nachschleifen. Kontrollieren, dass Schneidengeometrie Werkstoff entspricht.
	Kuschmiermittel ungenügend in Bezug auf Schmierfähigkeit und / oder Zufuhr	Dafür sorgen, dass Kühlschmiermittel geeignet und ausreichend ist.

## APPLICATION AND USE OF THREADING TAPS

Problem	Causes	Solutions
<b>Partial chipping of tap</b>	Swarf jamming	Check cutting speed. Use alternative tap type (K / N.62.-3 / Z.70VS).
	Tap hits bottom of core hole	Check hole and thread depths. Drill core hole deeper.
	Irregular workpiece material structure	Adjust cutting speed. Improve lubricating quality of coolant. Use tap with other cutting geometry / other coating.
	Tap incorrectly re-ground (lead-in diameter too small, therefore too few cutting teeth)	Ensure that original values are maintained when re-grinding.

Problem	Causes	Solutions
<b>Excessive tap wear</b>	Incorrect cutting speed	Adjust cutting speed to suit workpiece material. Use tap with recommended surface coating.
	Coolant lacking in lubricating qualities and / or quantity	Ensure the use of a suitable coolant and an ample supply. Check that coolant is reaching the cutting zone.
	Surface of the core hole is compacted	Check core hole drilling conditions (drill carefully to reduce risk of surface compacting). Check drill cutting edges.
	Synchronization	Check status of synchronization. Avoid rigid tapping in materials with high mechanical properties.

Problem	Causes	Solutions
<b>Tap breakage</b>	Incorrect tap in use (cutting geometry unsuitable for application)	Use tap from the relevant material group.
	Bad swarf evacuation	Adapt cutting geometry to the depth to be tapped. Adapt length of flutes if necessary.
	Centering error	Ensure that axes of tap and core hole are aligned.
	Blunt tap	Re-grind tap. Ensure that taps are carefully stored.
	Tap has reached bottom of the core hole	Use tapping spindle with axial float and slipping clutch.
	Core hole too small	Select core hole as per chart in the technical part of this catalogue.

## APPLICATION AND USE OF THREADING TAPS

Problem	Causes	Solutions
<b>Tapped hole oversize</b>	Incorrect tap in use (cutting geometry unsuitable for application)	Use tap selected from the relevant material group.
	Faulty alignment	Ensure that the tap is correctly aligned with the core hole axis.
	Cold welding	Improve lubrication and direction of coolant. Adjust cutting speed. Use taps with recommended surface treatment or coating.
	Re-ground tap (lead-in is not concentric)	Re-grind tap lead correctly on a suitable tap grinding machine.

Problem	Causes	Solutions
<b>Stripped threads</b>	Incorrect tap in use (cutting geometry incorrect for application)	Use a tap from the relevant material group.
	Spindle speed and feed rate not synchronized	Check feed rate programming and / or pitch of leading spindle. Use a tapping spindle with axial float or a tapping chuck with axial shock absorber.
	Synchronization	Check status of synchronization. Avoid rigid tapping in materials with high mechanical properties.
	Insufficient start pressure exerted on tap with peeling-cut	Increase start pressure.

Problem	Causes	Solutions
<b>Bell mouthed tapped hole</b>	Incorrect start pressure applied to tap	Use a tapping spindle with axial float.

Problem	Causes	Solutions
<b>Unsatisfactory thread surface finish</b>	Incorrect tap in use (cutting geometry unsuitable for application)	Select tap from the relevant material group.
	The tap is blunt	Replace or re-grind tap.
	Tap badly re-ground	Re-grind tap again. Check that cutting geometry is suitable for material.
	Coolant lacking in lubricating qualities and / or quantity	Ensure the use of a suitable coolant and an ample supply.



# ANWENDUNGSTABELLE — APPLICATION CHART

**Gewindeschneiden  
Thread cutting**

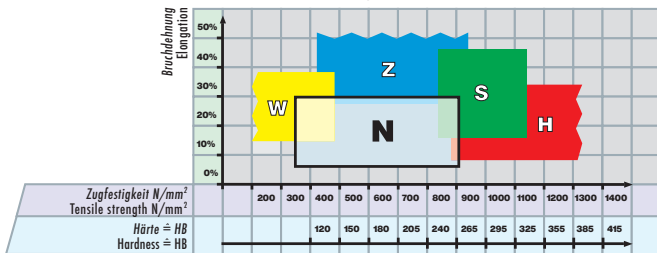

**Gewindeschneiden  
Thread cutting**

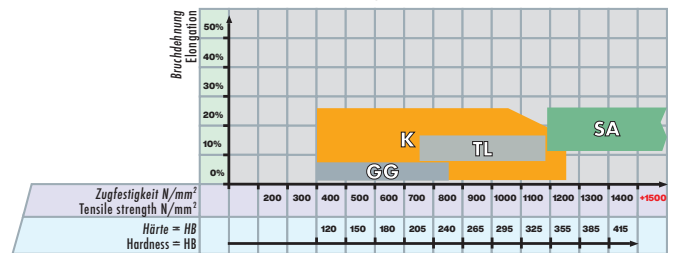

**DC -Anwendungsgruppen**

**DC Material classification**

Werkstoff-Gruppen Material groups	Werkstoffbezeichnung	Material designation	Härte Hardness (HB)	Festigkeit Tensile strength Rm (N/mm²)	Dehnung Elongation A (%)
<b>10</b> Stahl Steels	11 Automatenstahl	Free-cutting steels	< 200	< 700	< 10
	12 Baustahl, Einsatzstahl	Structural, cementation steels	< 200	< 700	< 30
	13 Kohlenstoffstahl	Carbon steels	< 300	< 1000	< 20
	14 Stahl legiert < 850 N/mm²	Alloy steels < 850 N/mm²	< 250	< 850	< 30
	15 Stahl legiert / vergütet > 850 - < 1150 N/mm²	Alloy steels hard. / temp. > 850 - < 1150 N/mm²	> 250	> 850	< 30
	16 Hochfester Stahl ≤ 44 HRC	High tensile alloy steels ≤ 44 HRC	> 250	> 850	< 12
	17 Stahl vergütet > 44 - ≤ 54 HRC	Alloy steels tempered > 44 - ≤ 54 HRC	> 410	> 1400	< 2
	18 Stahl gehärtet > 54 - ≤ 63 HRC	Alloy steels hardened > 54 - ≤ 63 HRC	> 560	> 1980	< 2
<b>20</b> Rostfreier Stahl Stainless steels	21 Rostfreier Stahl, geschwefelt	Free machining stainless steels	< 250	< 850	< 25
	22 Austenitisch	Austenitic stainless steels	< 250	< 850	> 20
	23 Ferritisch, martensitisch < 850 N/mm²	Ferritic and martensitic < 850 N/mm²	< 250	< 850	> 20
	24 Ferritisch, martensitisch > 850 - < 1150 N/mm²	Ferritic and martensitic > 850 - < 1150 N/mm²	> 250	> 850	> 15
<b>30</b> Guss Cast iron	31 Grauguss	Cast iron	< 250	< 850	< 10
	32 Kugelgraphitguss, Temperguss	Spheroidal graphite + malleable cast iron	< 250	< 850	> 10
<b>40</b> Titan Titanium	41 Reintitan	Pure titanium	< 250	< 850	> 20
	42 Titanlegierung	Titanium alloys	> 250	> 850	< 20
<b>50</b> Nickel Nickel	51 Nickellegierung 1 ≤ 850 N/mm²	Nickel alloys 1 ≤ 850 N/mm²	< 250	< 850	> 25
	52 Nickellegierung 2 > 850 - ≤ 1150 N/mm²	Nickel alloys 2 > 850 - ≤ 1150 N/mm²	> 250	> 850	< 25
	53 Nickellegierung 3 > 1150 - ≤ 1600 N/mm²	Nickel alloys 3 > 1150 - ≤ 1600 N/mm²	> 340	> 1150	< 20
<b>60</b> Kupfer Copper	61 Reinkupfer (Elektrolytkupfer)	Pure copper (electrolytic copper)	< 120	< 400	> 12
	62 Messing, Bronze, Rotguss (kurzspanend)	Short chip brass, phosphor bronze, gun metal	< 200	< 700	< 12
	63 Messing (langspanend)	Long chip brass	< 200	< 700	> 12
	64 Messing bleifrei	Lead free brass	< 220	< 700	> 15
<b>70</b> Aluminium Magnesium Aluminium Magnesium	71 Al unlegiert	Al unalloyed	< 100	< 350	> 15
	72 Al legiert Si < 1.5 %	Al alloyed Si < 1.5 %	< 150	< 500	> 15
	73 Al legiert Si > 1.5 % - < 10 %	Al alloyed Si > 1.5 % - < 10 %	< 120	< 400	< 15
	74 Al legiert Si > 10 %, Mg-Legierungen	Al alloyed Si > 10 %, Mg-alloys	< 120	< 400	< 10
<b>80</b> Kunststoff Plastic compounds	81 Thermoplaste	Thermoplastics	-	-	-
	82 Duroplaste	Duroplastics	-	-	-
	83 Faserverstärkte Kunststoffe	Glass fibre reinforced plastics	-	-	-
<b>90</b> Edelmetalle Precious metals	91 Gelbgold	Yellow gold	-	-	-
	92 Rotgold	Red gold	-	-	-
	93 Weissgold	White gold	-	-	-
	94 Silber	Silver	-	-	-

# KLASSISCHES GEWINDESCHNEIDEN — CLASSIC THREAD CUTTING



<b>Ab Seite:</b> <b>From page:</b>
<b>MJ / M</b>
<b>MF</b>
<b>UNJC / UNC / UNC(J)</b>
<b>UNJF / UNF / UNF(J)</b>
<b>UNEF / UN / UNS</b>
<b>G / Rp / Rc / W / SV</b>
<b>NPT / NPTF</b>
<b>PG / TR</b>
<b>EG M / EG UNC / EG UNF</b>

<b>N</b> Normale Werkstoffe Normal materials											
60	62	60	64	64	72	72	74	60	74	74	
125	124	125	125		124		131	131	131		
154	154	154	154				156	156	156		
176	176	176	176				178	178	178		
198	198						199	199			
204	205	205	205				206	206	206		
220											
222	222										
	226	226					227	227			



	<b>V<sub>c</sub></b> (m/min) Guide Line					
	Ø 1 - 2.8 mm		Ø 2.8 - 26 mm		Ø 26 - 60 mm	
	Standard Standard	Beschichtet Coated	Standard Standard	Beschichtet Coated	Standard Standard	Beschichtet Coated
11	10 - 15	10 - 20	10 - 15	25 - 35	5 - 10	
12	10 - 15	10 - 20	10 - 15	25 - 35	5 - 10	
13	8 - 12	10 - 20	8 - 12	16 - 24	10 - 15	
14	8 - 12	10 - 20	8 - 12	16 - 24	4 - 8	
15	2 - 4	4 - 10	3 - 5	6 - 12	2 - 4	3 - 5
16		2 - 4	3 - 5	3 - 5	2 - 4	3 - 5
17			2 - 4			
18						
21	4 - 10	10 - 15	10 - 15	20 - 30	5 - 10	
22	3 - 6	4 - 8	3 - 6	6 - 12		
23	3 - 6	4 - 8	3 - 6	6 - 12		
24		3 - 5		4 - 8		3 - 5
31	10 - 15	10 - 20	10 - 15	20 - 30	5 - 10	15 - 25
32	10 - 15	10 - 20	10 - 15	20 - 30	5 - 10	
41	2 - 4	4 - 8	4 - 8	4 - 8		
42	2 - 4	3 - 5	3 - 5	3 - 5		
51		3 - 5		6 - 12		
52			4 - 8	4 - 8		
53			2 - 4			
61	8 - 12		8 - 12	12 - 16	4 - 8	
62	6 - 12	6 - 12	20 - 30	30 - 40	15 - 25	25 - 35
63	10 - 20		16 - 24		8 - 12	
64	10 - 20		16 - 24		8 - 12	
71	10 - 15	10 - 15	10 - 15	20 - 40	5 - 10	
72	10 - 20	20 - 30	20 - 30	20 - 40	10 - 15	
73	10 - 15	10 - 20	10 - 15	20 - 30	5 - 10	
74	10 - 15	10 - 20	10 - 15	20 - 30	5 - 10	
81	10 - 20		20 - 30	30 - 50	10 - 15	
82	8 - 16	16 - 24	8 - 16	16 - 24	5 - 12	10 - 15
83		6 - 12		8 - 16		5 - 12
91	12 - 20		20 - 30			
92		12 - 16		12 - 16		
93		4 - 8		4 - 8		
94		12 - 20		16 - 24		

N.10	N.20	N.20V	N.20TN	N.20TC	N.50	N.50V	N.60	N.60V	N.60TN	N.60TC





# KLASSISCHES GEWINDESCHNEIDEN – CLASSIC THREAD CUTTING



<b>Ab Seite:</b> <b>From page:</b>
<b>MJ / M</b>
<b>MF</b>
<b>UNJC / UNC / UNC(J)</b>
<b>UNJF / UNF / UNF(J)</b>
<b>UNEF / UN / UNS</b>
<b>G / Rp / Rc / W / SV</b>
<b>NPT / NPTF</b>
<b>PG / TR</b>
<b>EG M / EG UNC / EG UNF</b>

AERO								
SA Sonderlegierte Werkstoffe Special alloys			TL Titanleg. Titan. alloys		GG Grauguss / Alu-Guss Cast iron / Al casting			
47	47	46	100	47	102	102	102	
140	140	139	140	140				
49	49	48	165	49				
51	51	50		51				
					207			
228	228	229	232	228				

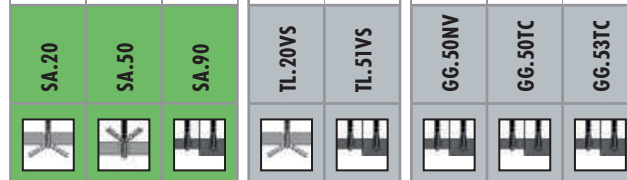

	Vc (m/min) Guide Line						SA			TL		GG			
	Ø 1 - 2.8 mm		Ø 2.8 - 26 mm		Ø 26 - 60 mm		SA.20	SA.50	SA.90	TL.20VS	TL.51VS	GG.50NV	GG.50TC	GG.53TC	
	Standard Standard	Beschichtet Coated	Standard Standard	Beschichtet Coated	Standard Standard	Beschichtet Coated									
11	10 - 15	10 - 20	10 - 15	25 - 35	5 - 10										11
12	10 - 15	10 - 20	10 - 15	25 - 35	5 - 10										12
13	8 - 12	10 - 20	8 - 12	16 - 24	10 - 15										13
14	8 - 12	10 - 20	8 - 12	16 - 24	4 - 8										14
15	2 - 4	4 - 10	3 - 5	6 - 12	2 - 4	3 - 5									15
16		2 - 4	3 - 5	3 - 5	2 - 4	3 - 5									16
17			2 - 4												17
18															18
21	4 - 10	10 - 15	10 - 15	20 - 30	5 - 10										21
22	3 - 6	4 - 8	3 - 6	6 - 12											22
23	3 - 6	4 - 8	3 - 6	6 - 12											23
24		3 - 5		4 - 8		3 - 5									24
31	10 - 15	10 - 20	10 - 15	20 - 30	5 - 10	15 - 25									31
32	10 - 15	10 - 20	10 - 15	20 - 30	5 - 10										32
41	2 - 4	4 - 8	4 - 8	4 - 8											41
42	2 - 4	3 - 5	3 - 5	3 - 5											42
51		3 - 5		6 - 12											51
52			4 - 8	4 - 8											52
53			2 - 4												53
61	8 - 12		8 - 12	12 - 16	4 - 8										61
62	6 - 12	6 - 12	20 - 30	30 - 40	15 - 25	25 - 35									62
63	10 - 20		16 - 24		8 - 12										63
64	10 - 20		16 - 24		8 - 12										64
71	10 - 15	10 - 15	10 - 15	20 - 40	5 - 10										71
72	10 - 20	20 - 30	20 - 30	20 - 40	10 - 15										72
73	10 - 15	10 - 20	10 - 15	20 - 30	5 - 10										73
74	10 - 15	10 - 20	10 - 15	20 - 30	5 - 10										74
81	10 - 20		20 - 30	30 - 50	10 - 15										81
82	8 - 16	16 - 24	8 - 16	16 - 24	5 - 12	10 - 15									82
83		6 - 12		8 - 16		5 - 12									83
91	12 - 20		20 - 30												91
92		12 - 16		12 - 16											92
93		4 - 8		4 - 8											93
94		12 - 20		16 - 24											94

**A** Optimal mit Luft  
Optimal with air

**A** Geeignet mit Luft  
Suitable with air

**⊂** Bedingt geeignet  
Limited

Bei den oben aufgeführten Daten handelt es sich um Richtwerte.  
The indicated values are a guideline.



# KLASSISCHES UND SYNCHRON-GEWINDESCHNEIDEN CLASSIC THREAD CUTTING AND RIGID TAPPING



## Gewindeschneiden Thread cutting

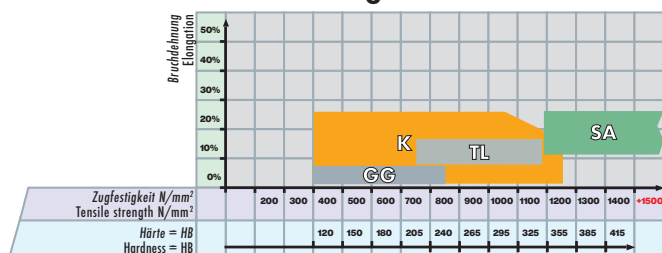

Ab Seite:  
From page:

MJ / M	104	105
MF	142	
UNJC / UNC / UNC(J)		
UNJF / UNF / UNF(J)		
UNEF / UN / UNS		
G / Rp / Rc / W / SV		
NPT / NPTF		
PG / TR		
EG M / EG UNC / EG UNF		

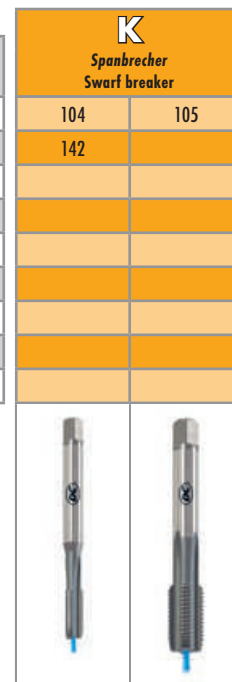

	Vc (m/min) Guide Line				K.137C	K.13VS	
	Ø 5 - 10.9 mm	Ø 11 - 18.9 mm	Ø 19 - 31.9 mm	Ø 32 - 42 mm			
	Beschichtet Coated	Beschichtet Coated	Beschichtet Coated	Beschichtet Coated			
11	30 - 40	20 - 30	20 - 30	20 - 30	E	E	11
12	30 - 40	20 - 30	20 - 30	20 - 30	E	E	12
13	30 - 40	20 - 30	20 - 30	20 - 30	E	E	13
14	20 - 30	15 - 25	15 - 25	15 - 25	E	E	14
15	15 - 20	10 - 15	8 - 12	5 - 8	E	E	15
16	8 - 12	5 - 8	5 - 8	5 - 8	E	E	16
17							17
18							18
21							21
22							22
23							23
24							24
31	30 - 40	30 - 40	30 - 40	30 - 40	E	E	31
32	30 - 40	20 - 30	20 - 30	20 - 30	E	E	32
41							41
42							42
51							51
52							52
53							53
61							61
62	30 - 40	30 - 40	30 - 40	30 - 40	E	E	62
63	30 - 40	30 - 40	30 - 40	30 - 40	E	E	63
64	30 - 40	20 - 30	20 - 30	20 - 30	E	E	64
71							71
72							72
73							73
74	30 - 40	30 - 40	30 - 40	30 - 40	E	E	74
81							81
82							82
83	30 - 40	30 - 40	30 - 40	30 - 40	E	E	83
91							91
92							92
93							93
94							94

# KLASSISCHES UND SYNCHRON-GEWINDESCHNEIDEN CLASSIC THREAD CUTTING AND RIGID TAPPING



## Gewindeschneiden klassisch und synchron Thread cutting classic and rigid

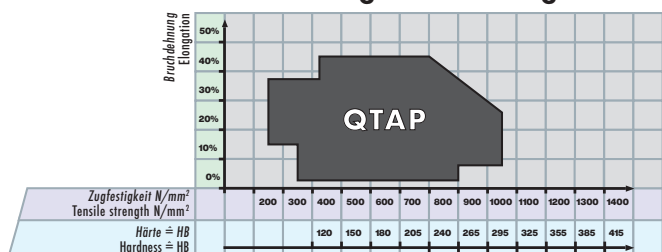

Ab Seite:  
From page:

MJ / M
MF
UNJC / UNC / UNC(J)
UNJF / UNF / UNF(J)
UNEF / UN / UNS
G / Rp / Rc / W / SV
NPT / NPTF
PG / TR
EG M / EG UNC / EG UNF

## QTAP Allrounder Allrounder

61	106	61	107
143	143	144	144
167	167	168	168
192	192	193	193
210	210	211	211

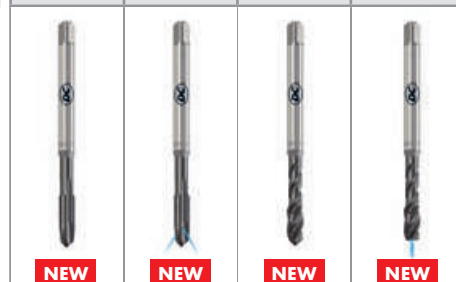

Q.20VS	Q.23VS	Q.60VS	Q.63VS

	Vc (m/min) Guide Line Ø 2.8 - 20 mm					
11	20 - 40	OE	OE	OE	OE	11
12	20 - 40	OE	OE	OE	OE	12
13	16 - 24	OE	OE	OE	OE	13
14	16 - 24	OE	OE	OE	OE	14
15	6 - 12	OE	OE	OE	OE	15
16						16
17						17
18						18
21	20 - 40	OE	OE	OE	OE	21
22	6 - 12	OE	OE	OE	OE	22
23	6 - 12	OE	OE	OE	OE	23
24	4 - 8	OE	OE	OE	OE	24
31	20 - 40	OE A	OE	OE A	OE	31
32	20 - 40	OE	OE	OE	OE	32
41						41
42						42
51	6 - 12	OE	OE	OE	OE	51
52	4 - 8	OE	OE	OE	OE	52
53						53
61	12 - 16	OE	OE	OE	OE	61
62	25 - 35	OE	OE	OE	OE	62
63	20 - 40	OE	OE	OE	OE	63
64	20 - 40	OE	OE	OE	OE	64
71	20 - 40	OE	OE	OE	OE	71
72	20 - 40	OE	OE	OE	OE	72
73	20 - 40	OE	OE	OE	OE	73
74	20 - 40	OE A	OE	OE A	OE	74
81	20 - 40	OE A	OE	OE A	OE	81
82	16 - 24	OE	OE	OE	OE	82
83	8 - 16	OE A	OE	OE A	OE	83
91	20 - 40	OE	OE	OE	OE	91
92	12 - 16	OE	OE	OE	OE	92
93						93
94	12 - 16	OE	OE	OE	OE	94

**A** Optimal mit Luft  
Optimal with air

**A** Geeignet mit Luft  
Suitable with air

**⊂** Bedingt geeignet  
Limited

Bei den oben aufgeführten Daten handelt es sich um Richtwerte.  
The indicated values are a guideline.





# ANWENDUNGSTABELLE — APPLICATION CHART

## Synchron-Gewindeschneiden Rigid Tapping

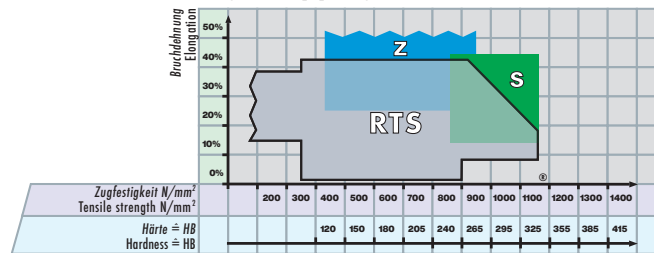

### DC -Anwendungsgruppen

### DC Material classification

Werkstoff-Gruppen Material groups		Werkstoffbezeichnung	Material designation	Härte Hardness (HB)	Festigkeit Tensile strength R <sub>m</sub> (N/mm <sup>2</sup> )	Dehnung Elongation A (%)
<b>10</b> Stahl Steels	11	Automatenstahl	Free-cutting steels	< 200	< 700	< 10
	12	Baustahl, Einsatzstahl	Structural, cementation steels	< 200	< 700	< 30
	13	Kohlenstoffstahl	Carbon steels	< 300	< 1000	< 20
	14	Stahl legiert < 850 N/mm <sup>2</sup>	Alloy steels < 850 N/mm <sup>2</sup>	< 250	< 850	< 30
	15	Stahl legiert / vergütet > 850 - < 1150 N/mm <sup>2</sup>	Alloy steels hard. / temp. > 850 - < 1150 N/mm <sup>2</sup>	> 250	> 850	< 30
	16	Hochfester Stahl ≤ 44 HRC	High tensile alloy steels ≤ 44 HRC	> 250	> 850	< 12
	17	Stahl vergütet > 44 - ≤ 54 HRC	Alloy steels tempered > 44 - ≤ 54 HRC	> 410	> 1400	< 2
	18	Stahl gehärtet > 54 - ≤ 63 HRC	Alloy steels hardened > 54 - ≤ 63 HRC	> 560	> 1980	< 2
<b>20</b> Rostfreier Stahl Stainless steels	21	Rostfreier Stahl, geschwefelt	Free machining stainless steels	< 250	< 850	< 25
	22	Austenitisch	Austenitic stainless steels	< 250	< 850	> 20
	23	Ferritisch, martensitisch < 850 N/mm <sup>2</sup>	Ferritic and martensitic < 850 N/mm <sup>2</sup>	< 250	< 850	> 20
	24	Ferritisch, martensitisch > 850 - < 1150 N/mm <sup>2</sup>	Ferritic and martensitic > 850 - < 1150 N/mm <sup>2</sup>	> 250	> 850	> 15
<b>30</b> Guss Cast iron	31	Grauguss	Cast iron	< 250	< 850	< 10
	32	Kugelgraphitguss, Temperguss	Spheroidal graphite + malleable cast iron	< 250	< 850	> 10
<b>40</b> Titan Titanium	41	Reintitan	Pure titanium	< 250	< 850	> 20
	42	Titanlegierung	Titanium alloys	> 250	> 850	< 20
<b>50</b> Nickel Nickel	51	Nickellegierung 1 ≤ 850 N/mm <sup>2</sup>	Nickel alloys 1 ≤ 850 N/mm <sup>2</sup>	< 250	< 850	> 25
	52	Nickellegierung 2 > 850 - ≤ 1150 N/mm <sup>2</sup>	Nickel alloys 2 > 850 - ≤ 1150 N/mm <sup>2</sup>	> 250	> 850	< 25
	53	Nickellegierung 3 > 1150 - ≤ 1600 N/mm <sup>2</sup>	Nickel alloys 3 > 1150 - ≤ 1600 N/mm <sup>2</sup>	> 340	> 1150	< 20
<b>60</b> Kupfer Copper	61	Reinkupfer (Elektrolytkupfer)	Pure copper (electrolytic copper)	< 120	< 400	> 12
	62	Messing, Bronze, Rotguss (kurzspanend)	Short chip brass, phosphor bronze, gun metal	< 200	< 700	< 12
	63	Messing (langspanend)	Long chip brass	< 200	< 700	> 12
	64	Messing bleifrei	Lead free brass	< 220	< 700	> 15
<b>70</b> Aluminium Magnesium Aluminium Magnesium	71	Al unlegiert	Al unalloyed	< 100	< 350	> 15
	72	Al legiert Si < 1.5 %	Al alloyed Si < 1.5 %	< 150	< 500	> 15
	73	Al legiert Si > 1.5 % - < 10 %	Al alloyed Si > 1.5 % - < 10 %	< 120	< 400	< 15
	74	Al legiert Si > 10 %, Mg-Legierungen	Al alloyed Si > 10 %, Mg-alloys	< 120	< 400	< 10
<b>80</b> Kunststoff Plastic compounds	81	Thermoplaste	Thermoplastics	-	-	-
	82	Duroplaste	Duroplastics	-	-	-
	83	Faserverstärkte Kunststoffe	Glass fibre reinforced plastics	-	-	-
<b>90</b> Edelmetalle Precious metals	91	Gelbgold	Yellow gold	-	-	-
	92	Rotgold	Red gold	-	-	-
	93	Weissgold	White gold	-	-	-
	94	Silber	Silver	-	-	-



# SYNCHRON-GEWINDESCHNEIDEN – RIGID TAPPING



<b>Ab Seite: From page:</b>
<b>MJ / M</b>
<b>MF</b>
<b>UNJC / UNC / UNC(J)</b>
<b>UNJF / UNF / UNF(J)</b>
<b>UNEF / UN / UNS</b>
<b>G / Rp / Rc / W / SV</b>
<b>NPT / NPTF</b>
<b>PG / TR</b>
<b>EG M / EG UNC / EG UNF</b>

RTS Synchro Synchro			
108	108	109	109
145		145	
169		169	
194		194	
		212	

Z Zähe Werkstoffe Tough materials	
90	90
134	
160	
182	
209	
231	

S Sonderlegierte Werkstoffe Special alloys	
46	On request
48	
50	

V <sub>c</sub> (m/min) Guide Line		
Ø 2 - 2.8 mm	Ø 2.8 - 20 mm	
Beschichtet Coated	Beschichtet Coated	
11	12 - 20	20 - 40
12	12 - 20	20 - 40
13	12 - 20	16 - 24
14	12 - 20	16 - 24
15	5 - 10	6 - 12
16		
17		
18		
21	12 - 20	20 - 40
22	4 - 10	6 - 12
23	4 - 10	6 - 12
24	4 - 8	4 - 8
31	12 - 20	20 - 40
32	12 - 20	20 - 40
41		
42		
51	4 - 10	6 - 12
52		4 - 8
53		
61	10 - 16	10 - 20
62		
63	12 - 20	20 - 40
64	12 - 20	20 - 40
71	12 - 20	30 - 50
72	12 - 20	30 - 50
73	12 - 20	20 - 40
74	12 - 20	20 - 40
81	12 - 20	30 - 50
82	12 - 20	16 - 24
83	4 - 10	8 - 16
91	12 - 20	20 - 40
92	6 - 12	12 - 16
93		
94	6 - 12	12 - 16

**A** Optimal mit Luft  
Optimal with air

**A** Geeignet mit Luft  
Suitable with air

Bedingt geeignet  
Limited

Bei den oben aufgeführten Daten handelt es sich um Richtwerte.  
The indicated values are a guideline.



# ANWENDUNGSTABELLE — APPLICATION CHART

## Gewindeformen Thread forming

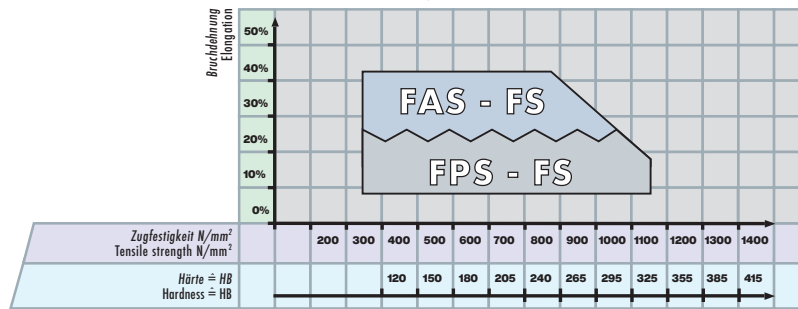

## DC -Anwendungsgruppen

## DC Material classification

Werkstoff-Gruppen Material groups	Werkstoffbezeichnung	Material designation	Härte Hardness (HB)	Festigkeit Tensile strength R <sub>m</sub> (N/mm <sup>2</sup> )	Dehnung Elongation A (%)
<b>10</b> Stahl Steels	11 Automatenstahl	Free-cutting steels	< 200	< 700	< 10
	12 Baustahl, Einsatzstahl	Structural, cementation steels	< 200	< 700	< 30
	13 Kohlenstoffstahl	Carbon steels	< 300	< 1000	< 20
	14 Stahl legiert < 850 N/mm <sup>2</sup>	Alloy steels < 850 N/mm <sup>2</sup>	< 250	< 850	< 30
	15 Stahl legiert / vergütet > 850 - < 1150 N/mm <sup>2</sup>	Alloy steels hard. / temp. > 850 - < 1150 N/mm <sup>2</sup>	> 250	> 850	< 30
	16 Hochfester Stahl ≤ 44 HRC	High tensile alloy steels ≤ 44 HRC	> 250	> 850	< 12
	17 Stahl vergütet > 44 - ≤ 54 HRC	Alloy steels tempered > 44 - ≤ 54 HRC	> 410	> 1400	< 2
	18 Stahl gehärtet > 54 - ≤ 63 HRC	Alloy steels hardened > 54 - ≤ 63 HRC	> 560	> 1980	< 2
<b>20</b> Rostfreier Stahl Stainless steels	21 Rostfreier Stahl, geschwefelt	Free machining stainless steels	< 250	< 850	< 25
	22 Austenitisch	Austenitic stainless steels	< 250	< 850	> 20
	23 Ferritisch, martensitisch < 850 N/mm <sup>2</sup>	Ferritic and martensitic < 850 N/mm <sup>2</sup>	< 250	< 850	> 20
	24 Ferritisch, martensitisch > 850 - < 1150 N/mm <sup>2</sup>	Ferritic and martensitic > 850 - < 1150 N/mm <sup>2</sup>	> 250	> 850	> 15
<b>30</b> Guss Cast iron	31 Grauguss	Cast iron	< 250	< 850	< 10
	32 Kugelgraphitguss, Temperguss	Spheroidal graphite + malleable cast iron	< 250	< 850	> 10
<b>40</b> Titan Titanium	41 Reintitan	Pure titanium	< 250	< 850	> 20
	42 Titanlegierung	Titanium alloys	> 250	> 850	< 20
<b>50</b> Nickel Nickel	51 Nickellegierung 1 ≤ 850 N/mm <sup>2</sup>	Nickel alloys 1 ≤ 850 N/mm <sup>2</sup>	< 250	< 850	> 25
	52 Nickellegierung 2 > 850 - ≤ 1150 N/mm <sup>2</sup>	Nickel alloys 2 > 850 - ≤ 1150 N/mm <sup>2</sup>	> 250	> 850	< 25
	53 Nickellegierung 3 > 1150 - ≤ 1600 N/mm <sup>2</sup>	Nickel alloys 3 > 1150 - ≤ 1600 N/mm <sup>2</sup>	> 340	> 1150	< 20
<b>60</b> Kupfer Copper	61 Reinkupfer (Elektrolytkupfer)	Pure copper (electrolytic copper)	< 120	< 400	> 12
	62 Messing, Bronze, Rotguss (kurzspanend)	Short chip brass, phosphor bronze, gun metal	< 200	< 700	< 12
	63 Messing (langspanend)	Long chip brass	< 200	< 700	> 12
	64 Messing bleifrei	Lead free brass	< 220	< 700	> 15
<b>70</b> Aluminium Magnesium Aluminium Magnesium	71 Al unlegiert	Al unalloyed	< 100	< 350	> 15
	72 Al legiert Si < 1.5 %	Al alloyed Si < 1.5 %	< 150	< 500	> 15
	73 Al legiert Si > 1.5 % - < 10 %	Al alloyed Si > 1.5 % - < 10 %	< 120	< 400	< 15
	74 Al legiert Si > 10 %, Mg-Legierungen	Al alloyed Si > 10 %, Mg-alloys	< 120	< 400	< 10
<b>80</b> Kunststoff Plastic compounds	81 Thermoplaste	Thermoplastics	-	-	-
	82 Duroplaste	Duroplastics	-	-	-
	83 Faserverstärkte Kunststoffe	Glass fibre reinforced plastics	-	-	-
<b>90</b> Edelmetalle Precious metals	91 Gelbgold	Yellow gold	-	-	-
	92 Rotgold	Red gold	-	-	-
	93 Weissgold	White gold	-	-	-
	94 Silber	Silver	-	-	-

<b>Ab Seite: From page:</b>	<b>FS</b>		<b>FPS</b>					<b>FAS</b>		
<b>M</b>	254	255	256	256	256	256	258	259	259	260
<b>MF</b>							262		262	
<b>UNC</b>	263						263		263	
<b>UNF</b>	264						264		264	
<b>G</b>							265		265	



<b>FS.80VS</b>	<b>FS.80DL</b>	<b>FPS.80DL</b>	<b>FPS.81DL</b>	<b>FPS.80VS</b>	<b>FPS.81VS</b>	<b>FPS.84VS</b>	<b>FAS.80VS</b>	<b>FAS.81VS</b>	<b>FAS.84VS</b>

<b>V<sub>c</sub> (m/min) Guide Line</b>	
Ø 1 - 2.8 mm	Ø 2.8 - 20 mm

11	12 - 20	20 - 40										11
12	12 - 20	20 - 40										12
13	12 - 20	20 - 30										13
14	12 - 20	20 - 30										14
15	6 - 12	10 - 15										15
16												16
17												17
18												18
21	12 - 20	10 - 20										21
22	6 - 12	10 - 15										22
23	6 - 12	6 - 12										23
24	6 - 12	6 - 12										24
31												31
32												32
41	12 - 20	10 - 20										41
42												42
51	6 - 12	10 - 15										51
52												52
53												53
61	12 - 20	10 - 20										61
62												62
63	12 - 20	20 - 30										63
64	12 - 20	20 - 30										64
71	12 - 20	20 - 40										71
72	12 - 20	20 - 40										72
73	12 - 20	20 - 40										73
74												74
81												81
82												82
83												83
91	12 - 20	20 - 40										91
92	12 - 20	20 - 40										92
93	12 - 20	20 - 40										93
94	12 - 20	20 - 40										94

## GEWINDEBOHRER NANO THREAD TAPS NANO

**DC** -Anwendungsgruppen

**DC** Material classification

Werkstoff-Gruppen Material groups		Werkstoffbezeichnung	Material designation	Härte Hardness (HB)	Festigkeit Tensile strength Rm (N/mm <sup>2</sup> )	Dehnung Elongation A (%)
<b>10</b> Stahl Steels	11	Automatenstahl	Free-cutting steels	< 200	< 700	< 10
	12	Baustahl, Einsatzstahl	Structural, cementation steels	< 200	< 700	< 30
	13	Kohlenstoffstahl	Carbon steels	< 300	< 1000	< 20
	14	Stahl legiert < 850 N/mm <sup>2</sup>	Alloy steels < 850 N/mm <sup>2</sup>	< 250	< 850	< 30
	15	Stahl legiert / vergütet > 850 - < 1150 N/mm <sup>2</sup>	Alloy steels hard. / temp. > 850 - < 1150 N/mm <sup>2</sup>	> 250	> 850	< 30
	16	Hochfester Stahl ≤ 44 HRC	High tensile alloy steels ≤ 44 HRC	> 250	> 850	< 12
	17	Stahl vergütet > 44 - ≤ 54 HRC	Alloy steels tempered > 44 - ≤ 54 HRC	> 410	> 1400	< 2
	18	Stahl gehärtet > 54 - ≤ 63 HRC	Alloy steels hardened > 54 - ≤ 63 HRC	> 560	> 1980	< 2
<b>20</b> Rostfreier Stahl Stainless steels	21	Rostfreier Stahl, geschwefelt	Free machining stainless steels	< 250	< 850	< 25
	22	Austenitisch	Austenitic stainless steels	< 250	< 850	> 20
	23	Ferritisch, martensitisch < 850 N/mm <sup>2</sup>	Ferritic and martensitic < 850 N/mm <sup>2</sup>	< 250	< 850	> 20
	24	Ferritisch, martensitisch > 850 - < 1150 N/mm <sup>2</sup>	Ferritic and martensitic > 850 - < 1150 N/mm <sup>2</sup>	> 250	> 850	> 15
<b>30</b> Guss Cast iron	31	Grauguss	Cast iron	< 250	< 850	< 10
	32	Kugelgraphitguss, Temperguss	Spheroidal graphite + malleable cast iron	< 250	< 850	> 10
<b>40</b> Titan Titanium	41	Reintitan	Pure titanium	< 250	< 850	> 20
	42	Titanlegierung	Titanium alloys	> 250	> 850	< 20
<b>50</b> Nickel Nickel	51	Nickellegierung 1 ≤ 850 N/mm <sup>2</sup>	Nickel alloys 1 ≤ 850 N/mm <sup>2</sup>	< 250	< 850	> 25
	52	Nickellegierung 2 > 850 - ≤ 1150 N/mm <sup>2</sup>	Nickel alloys 2 > 850 - ≤ 1150 N/mm <sup>2</sup>	> 250	> 850	< 25
	53	Nickellegierung 3 > 1150 - ≤ 1600 N/mm <sup>2</sup>	Nickel alloys 3 > 1150 - ≤ 1600 N/mm <sup>2</sup>	> 340	> 1150	< 20
<b>60</b> Kupfer Copper	61	Reinkupfer (Elektrolytkupfer)	Pure copper (electrolytic copper)	< 120	< 400	> 12
	62	Messing, Bronze, Rotguss (kurzspanend)	Short chip brass, phosphor bronze, gun metal	< 200	< 700	< 12
	63	Messing (langspanend)	Long chip brass	< 200	< 700	> 12
	64	Messing bleifrei	Lead free brass	< 220	< 700	> 15
<b>70</b> Aluminium Magnesium Aluminium Magnesium	71	Al unlegiert	Al unalloyed	< 100	< 350	> 15
	72	Al legiert Si < 1.5 %	Al alloyed Si < 1.5 %	< 150	< 500	> 15
	73	Al legiert Si > 1.5 % - < 10 %	Al alloyed Si > 1.5 % - < 10 %	< 120	< 400	< 15
	74	Al legiert Si > 10 %, Mg-Legierungen	Al alloyed Si > 10 %, Mg-alloys	< 120	< 400	< 10
<b>80</b> Kunststoff Plastic compounds	81	Thermoplaste	Thermoplastics	-	-	-
	82	Duroplaste	Duroplastics	-	-	-
	83	Faserverstärkte Kunststoffe	Glass fibre reinforced plastics	-	-	-
<b>90</b> Edelmetalle Precious metals	91	Gelbgold	Yellow gold	-	-	-
	92	Rotgold	Red gold	-	-	-
	93	Weissgold	White gold	-	-	-
	94	Silber	Silver	-	-	-



## GEWINDEFORMER NANO THREAD FORMERS NANO

**DC** -Anwendungsgruppen

**DC** Material classification

Werkstoff-Gruppen Material groups		Werkstoffbezeichnung	Material designation	Härte Hardness (HB)	Festigkeit Tensile strength Rm (N/mm <sup>2</sup> )	Dehnung Elongation A (%)
<b>10</b> Stahl Steels	11	Automatenstahl	Free-cutting steels	< 200	< 700	< 10
	12	Baustahl, Einsatzstahl	Structural, cementation steels	< 200	< 700	< 30
	13	Kohlenstoffstahl	Carbon steels	< 300	< 1000	< 20
	14	Stahl legiert < 850 N/mm <sup>2</sup>	Alloy steels < 850 N/mm <sup>2</sup>	< 250	< 850	< 30
	15	Stahl legiert / vergütet > 850 - < 1150 N/mm <sup>2</sup>	Alloy steels hard. / temp. > 850 - < 1150 N/mm <sup>2</sup>	> 250	> 850	< 30
	16	Hochfester Stahl ≤ 44 HRC	High tensile alloy steels ≤ 44 HRC	> 250	> 850	< 12
	17	Stahl vergütet > 44 - ≤ 54 HRC	Alloy steels tempered > 44 - ≤ 54 HRC	> 410	> 1400	< 2
	18	Stahl gehärtet > 54 - ≤ 63 HRC	Alloy steels hardened > 54 - ≤ 63 HRC	> 560	> 1980	< 2
<b>20</b> Rostfreier Stahl Stainless steels	21	Rostfreier Stahl, geschwefelt	Free machining stainless steels	< 250	< 850	< 25
	22	Austenitisch	Austenitic stainless steels	< 250	< 850	> 20
	23	Ferritisch, martensitisch < 850 N/mm <sup>2</sup>	Ferritic and martensitic < 850 N/mm <sup>2</sup>	< 250	< 850	> 20
	24	Ferritisch, martensitisch > 850 - < 1150 N/mm <sup>2</sup>	Ferritic and martensitic > 850 - < 1150 N/mm <sup>2</sup>	> 250	> 850	> 15
<b>30</b> Guss Cast iron	31	Grauguss	Cast iron	< 250	< 850	< 10
	32	Kugelgraphitguss, Temporguss	Spheroidal graphite + malleable cast iron	< 250	< 850	> 10
<b>40</b> Titan Titanium	41	Reintitan	Pure titanium	< 250	< 850	> 20
	42	Titanlegierung	Titanium alloys	> 250	> 850	< 20
<b>50</b> Nickel Nickel	51	Nickellegierung 1 ≤ 850 N/mm <sup>2</sup>	Nickel alloys 1 ≤ 850 N/mm <sup>2</sup>	< 250	< 850	> 25
	52	Nickellegierung 2 > 850 - ≤ 1150 N/mm <sup>2</sup>	Nickel alloys 2 > 850 - ≤ 1150 N/mm <sup>2</sup>	> 250	> 850	< 25
	53	Nickellegierung 3 > 1150 - ≤ 1600 N/mm <sup>2</sup>	Nickel alloys 3 > 1150 - ≤ 1600 N/mm <sup>2</sup>	> 340	> 1150	< 20
<b>60</b> Kupfer Copper	61	Reinkupfer (Elektrolytkupfer)	Pure copper (electrolytic copper)	< 120	< 400	> 12
	62	Messing, Bronze, Rotguss (kurzspanend)	Short chip brass, phosphor bronze, gun metal	< 200	< 700	< 12
	63	Messing (langspanend)	Long chip brass	< 200	< 700	> 12
	64	Messing bleifrei	Lead free brass	< 220	< 700	> 15
<b>70</b> Aluminium Magnesium Aluminium Magnesium	71	Al unlegiert	Al unalloyed	< 100	< 350	> 15
	72	Al legiert Si < 1.5 %	Al alloyed Si < 1.5 %	< 150	< 500	> 15
	73	Al legiert Si > 1.5 % - < 10 %	Al alloyed Si > 1.5 % - < 10 %	< 120	< 400	< 15
	74	Al legiert Si > 10 %, Mg-Legierungen	Al alloyed Si > 10 %, Mg-alloys	< 120	< 400	< 10
<b>80</b> Kunststoff Plastic compounds	81	Thermoplaste	Thermoplastics	-	-	-
	82	Duroplaste	Duroplastics	-	-	-
	83	Faserverstärkte Kunststoffe	Glass fibre reinforced plastics	-	-	-
<b>90</b> Edelmetalle Precious metals	91	Gelbgold	Yellow gold	-	-	-
	92	Rotgold	Red gold	-	-	-
	93	Weissgold	White gold	-	-	-
	94	Silber	Silver	-	-	-

# GEWINDEFORMER NANO — THREAD FORMERS NANO



<b>Ab Seite: From page:</b>
<b>M</b>
<b>MF</b>
<b>UNC</b>
<b>UNF</b>
<b>S</b>
<b>SF</b>
<b>SL</b>

<b>FA</b> Normale Werkstoffe Normal materials		<b>CFA</b> Nichteisen-Metalle Non-ferrous materials	
363	363	370	370
364	364		
365	365	371	371
366	366	372	372
367	367	373	373
368	368		
369	369		
<b>FA80VS</b>	<b>FA83VS</b>	<b>CFA80VS</b>	<b>CFA83VS</b>

	<b>Vc</b> (m/min) Guide Line				
	Ø 0.3 - 1.4 mm Beschichtet Coated	Ø 1.4 - 2.8 mm Beschichtet Coated			
11	4 - 10	12 - 20			11
12	4 - 10	12 - 20			12
13	4 - 10	12 - 20			13
14	4 - 10	12 - 20			14
15	3 - 6	6 - 12			15
16					16
17					17
18					18
21	4 - 10	12 - 20			21
22	3 - 6	6 - 12			22
23	3 - 6	6 - 12			23
24	3 - 6	6 - 12			24
31					31
32					32
41					41
42					42
51	3 - 6	6 - 12			51
52					52
53					53
61	4 - 10	12 - 20			61
62	4 - 10	12 - 20			62
63	4 - 10	12 - 20			63
64	4 - 10	12 - 20			64
71	4 - 10	12 - 20			71
72	4 - 10	12 - 20			72
73	4 - 10	12 - 20			73
74					74
81					81
82					82
83					83
91	4 - 10	12 - 20			91
92	4 - 10	12 - 20			92
93	4 - 10	12 - 20			93
94	4 - 10	12 - 20			94





# KONSTRUKTIONSFORMEN FÜR GEWINDEBOHRER

## CONSTRUCTIONAL DESIGN OF THREADING TAPS

		<b>Ausführung nach ISO / DIN Allgemeine Baumasse</b>	<b>Design according to ISO / DIN General dimensions</b>
ISO 529 DIN 5157 (G)	N1110-. / N1210-. N210-. (G)	Handgewindebohrer mit abgestuften Flankendurchmesser	Hand taps with stepped pitch diameter
ISO 529  DIN 5157 (G)	N1110-3 / N1210-3 N1120-4 / N1220-4 N1160-3 / N1260-3 N210-3 / N220-4 (G)	Kurze Maschinen-Gewindebohrer	Short machine taps
DIN 352	NP110-S NP210-S	Handgewindebohrer mit abgestuften Flankendurchmesser, Vorschneider - 1 mit Führungszapfen	Hand taps with stepped pitch diameter, taper tap - 1 with guiding pilot
DIN 371	N3.; W3.; Z3.; H3.; S3.; SA3.; TL3.; GG3.; K3.; Q3.; RTS3.;	Maschinengewindebohrer mit verstärktem DIN-Schaft	Machine taps with reinforced DIN shank
DIN 376 / DIN 374 / DIN 5156 (G)	N4.; W4.; Z4.; H4.; S4.; SA4.; TL4.; GG4.; K4.; Q4.; RTS4.;	Maschinengewindebohrer mit durchfallendem DIN-Schaft	Machine taps with reduced DIN shank

		<b>Ausführung nach DC-Werksnorm Allgemeine Baumasse</b>	<b>Design according to DC standards General dimensions</b>
DC	K613	Extra-langer Maschinengewindebohrer mit langen Nuten und durchfallendem DIN-Schaft	Extra-long machine taps with long flutes and reduced DIN shank
DC / DIN 371	N5.; GG5.; RTS5.;	Extra-langer Maschinengewindebohrer mit verstärktem DIN-Schaft Totallänge gemäss DC-Werksnorm, Schaftmasse gemäss DIN 371	Extra-long machine taps with reinforced DIN shank Overall length as per norm DC, shank dimensions as per DIN 371
DC / DIN 376	N6.; GG6.; RTS6.; K6.;	Extra-langer Maschinengewindebohrer mit durchfallendem DIN-Schaft Totallänge gemäss DC-Werksnorm, Schaftmasse gemäss DIN 376	Extra-long machine taps with reduced DIN shank Overall length as per norm DC, shank dimensions as per DIN 376
DC	N470V-	Kronen-Gewindebohrer	Crown taps
DC	N5951 / N5952	Kombi-Gewindebohrer	Combination drill/tap



# KONSTRUKTIONSFORMEN FÜR GEWINDEFORMER

## CONSTRUCTIONAL DESIGN OF THREAD FORMING TAPS

		<b>Ausführung nach DIN Allgemeine Baumasse</b>	<b>Design according to DIN General dimensions</b>
~ DIN 2174 (M - MF) ~ DIN 2184-1 (UNC - UNF)	FS3..; FAS3..; FPS3..;	<i>Maschinengewindeformer mit verstärktem DIN-Schaft</i>	Machine thread formers with reinforced DIN shank
~ DIN 2174 (M - MF) ~ DIN 2184-1 (UNC - UNF) ~ DIN 2189 (G)	FAS4..; FPS4..;	<i>Maschinengewindeformer mit durchfallendem DIN-Schaft</i>	Machine thread formers with reduced DIN shank

		<b>Ausführung nach DC-Werksnorm Allgemeine Baumasse</b>	<b>Design according to DC standards General dimensions</b>
DC / ~ DIN 2174	FAS5..; FPS5..;	<i>Extra-langer Maschinengewindeformer mit verstärktem DIN-Schaft Totallänge gemäss DC-Werksnorm, Schaftmasse ähnlich DIN 2174</i>	Extra-long machine thread formers with reinforced DIN shank Overall length as per norm DC, shank dimensions similar to DIN 2174
DC / ~ DIN 2174	FAS6..; FPS6..;	<i>Extra-langer Maschinengewindeformer mit durchfallendem DIN-Schaft Totallänge gemäss DC-Werksnorm, Schaftmasse ähnlich DIN 2174</i>	Extra-long machine thread formers with reduced DIN shank Overall length as per norm DC, shank dimensions similar to DIN 2174

# HÄRTEVERGLEICHSTABELLE — HARDNESS CHART

<b>HRC</b> <i>Rockwellhärte</i> Hardness Rockwell	<b>HB</b> <i>Brinellhärte</i> Hardness Brinell	<b>HV</b> <i>Vickershärte</i> Hardness Vickers	<b>N/mm<sup>2</sup> Mpa</b> <i>Zugfestigkeit</i> Tensile strength
25	253	266	854
26	259	273	873
27	265	279	897
28	272	286	919
29	279	294	944
30	287	302	970
31	295	310	995
32	303	318	1024
33	311	327	1052
34	320	336	1082
35	328	345	1111
36	337	355	1139
37	346	364	1168
38	354	373	1198
39	363	382	1227
40	373	392	1262
41	382	402	1296
42	392	412	1327
43	402	423	1362
44	413	434	1401
45	424	446	1442
46	436	459	1481
47	448	471	1524
48	460	484	1572
49	474	499	1625
50	488	513	1675
51	502	528	1733
52	518	545	1793
53	532	560	1845
54	549	578	1912
55	566	596	1979
56	585	615	2050
57	603	634	2121
58	621	654	2200
59		675	
60		698	
61		720	
62		746	
63		773	

*Umrechnungstabelle für Härtewerte, Auszug aus ISO EN 18265; 2003 / früher DIN 50150. Gerundete Werte.*  
*Conversion chart for hardness values, extract from ISO EN 18265; 2003 / formerly DIN 50150. Rounded values.*

# ZOLL-MM – INCHES-MM

Ø" d <sub>1</sub>	Ø mm	TPI UN											W(BSW)	BSF	G (BSP) Rp	Ø mm	
		UNC	UNF	UNEF	4	6	8	12	16	20	28	32					
0 1/16"	1.52 1.59		80											48		28	7.72
1 2 3/32"	1.85 2.18 2.38	64 56	72 64														
3 4 5 1/8"	2.51 2.84 3.17 3.17	48 40 40	56 48 44											40		28	9.72
6 5/32"	3.50	32	40														
8 3/16"	3.96 4.16 4.76	32	36											32	32		
10 12	4.82 5.48	24 24	32 28	32													
7/32"	5.55													24	28		
1/4"	6.35	20	28	32										20	26	19	13.15
9/32"	7.14														26		
5/16"	7.93	18	24	32					20	28							
3/8"	9.52	16	24	32					20	28				16	20	19	16.66
7/16"	11.11	14	20	28					16					14	18		
1/2"	12.70	13	20	28					16					12	16	14	20.95
9/16"	14.28	12	18	24					16	20	28			12	16		
5/8"	15.87	11	18	24				12	16	20	28	32		11	14	14	22.91
11/16"	17.46			24				12	16	20	28	32			14		
3/4"	19.05	10	16	20				12			28	32		10	12	14	26.44
13/16"	20.64			20				12	16		28	32			12		
7/8"	22.22	9	14	20				12	16		28	32		9	11	14	30.20
15/16"	23.81			20				12	16		28	32					
1"	25.40	8	12	20				12	16		28	32		8	10	11	33.24
1 1/16"	26.99			18			8	12	16	20	28						
1 1/8"	28.57	7	12	18			8		16	20	28			7	9	11	37.89
1 3/16"	30.16			18			8	12	16	20	28						
1 1/4"	31.75	7	12	18			8		16	20	28			7	9	11	41.91
1 5/16"	33.34			18			8	12	16	20	28						
1 3/8"	34.92	6	12	18			8		16	20	28			6	8	11	44.32
1 7/16"	36.51			18			8	12	16	20	28						
1 1/2"	38.10	6	12	18		6	8	12	16	20	28			6	8	11	47.80
1 9/16"	39.69			18		6	8	12	16	20							
1 5/8"	41.28			18		6	8	12	16	20				5	8		
1 11/16"	42.86			18													
1 3/4"	44.45	5				6	8	12	16	20				5	7	11	53.74
1 13/16"	46.04					6	8	12	16	20							
1 7/8"	47.63					6	8	12	16	20				4 1/2			
1 15/16"	49.21					6	8	12	16	20							
2"	50.80	4 1/2												4 1/2	7	11	59.61
2 1/8"	53.97					6	8	12	16	20							
2 1/4"	57.15	4 1/2				6	8	12	16	20				4	6	11	65.71
2 3/8"	60.32					6	8	12	16	20							
2 1/2"	63.50	4				6	8	12	16	20				4	6	11	75.18
2 5/8"	66.67				4	6	8	12	16	20							
2 3/4"	69.85	4				6	8	12	16	20				3 1/2	6	11	81.53
2 7/8"	73.02				4	6	8	12	16	20							
3"	76.20	4				6	8	12	16	20				3 1/2	5	11	87.88
3 1/8"	79.37				4	6	8	12	16								
3 1/4"	82.55	4				6	8	12	16					3 1/4	5	11	93.98
3 3/8"	85.72				4	6	8	12	16								
3 1/2"	88.90	4				6	8	12	16					3 1/4	4 1/2	11	100.33
3 5/8"	92.07				4	6	8	12	16								
3 3/4"	95.25	4				6	8	12	16					3	4 1/2	11	106.68
3 7/8"	98.42				4	6	8	12	16								
4"	101.60	4				6	8	12	16					3	4 1/2	11	113.03

# UMRECHNUNGSTABELLE – CONVERSION TABLE

		Vc m/min															
		1	2	3	4	5	6	8	10	12	15	20	25	30	40	50	60
		min <sup>-1</sup>															
Ø d <sub>1</sub>	1	318	637	955	1273	1592	1910	2546	3183	3820	4775	6366	7958	9549	12732	15915	19099
	2	159	318	477	637	796	955	1273	1592	1910	2387	3183	3979	4775	6366	7958	9549
	3	106	212	318	424	531	637	849	1061	1273	1592	2122	2653	3183	4244	5305	6366
	4	80	159	239	318	398	477	637	796	955	1194	1592	1989	2387	3183	3979	4775
	5	64	127	191	255	318	382	509	637	764	955	1273	1592	1910	2546	3183	3820
	6	53	106	159	212	265	318	424	531	637	796	1061	1326	1592	2122	2653	3183
	8	40	80	119	159	199	239	318	398	477	597	796	995	1194	1592	1989	2387
	10	32	64	95	127	159	191	255	318	382	477	637	796	955	1273	1592	1910
	12	27	53	80	106	133	159	212	265	318	398	531	663	796	1061	1326	1592
	14	23	45	68	91	114	136	182	227	273	341	455	568	682	909	1137	1364
	16	20	40	60	80	99	119	159	199	239	298	398	497	597	796	995	1194
	18	18	35	53	71	88	106	141	177	212	265	354	442	531	707	884	1061
	20	16	32	48	64	80	95	127	159	191	239	318	398	477	637	796	955
	25	13	25	38	51	64	76	102	127	153	191	255	318	382	509	637	764
	30	11	21	32	42	53	64	85	106	127	159	212	265	318	424	531	637
	35	9	18	27	36	45	55	73	91	109	136	182	227	273	364	455	546
	40	8	16	24	32	40	48	64	80	95	119	159	199	239	318	398	477
45	7	14	21	28	35	42	57	71	85	106	141	177	212	283	354	424	
50	6	13	19	25	32	38	51	64	76	95	127	159	191	255	318	382	



# KERNLOCHBOHRUNGEN – CORE HOLES

## M ISO DIN 14 4H5H (empfohlen / recommended)

Ø	P	Kern-Ø Mutter - Core Ø nut		Ø guide line
		Ø mini	Ø maxi	
d <sub>1</sub>	mm			
0.3	0.080	0.223	0.240	0.23
0.35	0.090	0.264	0.286	0.28
0.4	0.100	0.304	0.330	0.32
0.5	0.125	0.380	0.415	0.41
0.6	0.150	0.456	0.502	0.50
0.7	0.175	0.532	0.585	0.58
0.8	0.200	0.608	0.665	0.66
0.9	0.225	0.684	0.745	0.74



## MF DIN 13, ISO 261, \*4H / 6H

Ø	P	Kern-Ø Mutter - Core Ø nut		Ø guide line
		Ø mini	Ø maxi	
d <sub>1</sub>	mm			
*1.4	0.20	1.183	1.221	1.20
*1.6	0.20	1.383	1.421	1.40
*1.8	0.20	1.583	1.621	1.60
*2	0.20	1.783	1.821	1.80
*2	0.25	1.729	1.774	1.75
*2.2	0.20	1.983	2.021	2.00
*2.2	0.25	1.929	1.974	1.95
*2.3	0.20	2.083	2.121	2.10
*2.3	0.25	2.029	2.074	2.05
*2.5	0.20	2.283	2.321	2.30
*2.5	0.25	2.229	2.274	2.25
2.5	0.35	2.121	2.221	2.15
2.6	0.35	2.221	2.321	2.25
3	0.35	2.621	2.721	2.65
3.5	0.35	3.121	3.221	3.15
4	0.50	3.459	3.599	3.50
4.5	0.50	3.959	4.099	4.00
5	0.50	4.459	4.599	4.50
5.5	0.50	4.959	5.099	5.00
6	0.75	5.188	5.378	5.25
7	0.75	6.188	6.378	6.25
8	0.75	7.188	7.378	7.25
8	1.00	6.917	7.153	7.00
9	0.75	8.188	8.378	8.25
9	1.00	7.917	8.153	8.00
10	0.75	9.188	9.378	9.25
10	1.00	8.917	9.153	9.00
10	1.25	8.647	8.912	8.80
11	0.75	10.188	10.378	10.25
11	1.00	9.917	10.153	10.00
12	1.00	10.917	11.153	11.00
12	1.25	10.647	10.912	10.80
12	1.50	10.376	10.676	10.50
14	1.00	12.917	13.153	13.00
14	1.25	12.647	12.912	12.80
14	1.50	12.376	12.676	12.50
15	1.00	13.917	14.153	14.00
15	1.50	13.376	13.676	13.50
16	1.00	14.917	15.153	15.00
16	1.50	14.376	14.676	14.50
17	1.00	15.917	16.153	16.00
17	1.50	15.376	15.676	15.50
18	1.00	16.917	17.153	17.00
18	1.50	16.376	16.676	16.50
18	2.00	15.835	16.210	16.00
20	1.00	18.917	19.153	19.00
20	1.50	18.376	18.676	18.50
20	2.00	17.835	18.210	18.00
22	1.00	20.917	21.153	21.00
22	1.50	20.376	20.676	20.50
22	2.00	19.835	20.210	20.00
24	1.00	22.917	23.153	23.00
24	1.50	22.376	22.676	22.50
24	2.00	21.835	22.210	22.00
25	1.00	23.917	24.153	24.00
25	1.50	23.376	23.676	23.50
25	2.00	22.835	23.210	23.00



## M DIN 13, ISO 261, \*5H / 6H

Ø	P	Kern-Ø Mutter - Core Ø nut		Ø guide line
		Ø mini	Ø maxi	
d <sub>1</sub>	mm			
*1	0.25	0.729	0.785	0.75
*1.1	0.25	0.829	0.885	0.85
*1.2	0.25	0.929	0.985	0.95
*1.4	0.30	1.075	1.142	1.10
1.6	0.35	1.221	1.321	1.25
1.7	0.35	1.321	1.421	1.35
1.8	0.35	1.421	1.521	1.45
2	0.40	1.567	1.679	1.60
2.2	0.45	1.713	1.838	1.75
2.3	0.40	1.867	1.979	1.90
2.5	0.45	2.013	2.138	2.05
2.6	0.45	2.113	2.238	2.15
3	0.50	2.459	2.599	2.50
3.5	0.60	2.850	3.010	2.90
4	0.70	3.242	3.422	3.30
4.5	0.75	3.688	3.878	3.75
5	0.80	4.134	4.334	4.20
6	1.00	4.917	5.153	5.00
7	1.00	5.917	6.153	6.00
8	1.25	6.647	6.912	6.80
9	1.25	7.647	7.912	7.80
10	1.50	8.376	8.676	8.50
11	1.50	9.376	9.676	9.50
12	1.75	10.106	10.441	10.20
14	2.00	11.835	12.210	12.00
16	2.00	13.835	14.210	14.00
18	2.50	15.294	15.744	15.50
20	2.50	17.294	17.744	17.50
22	2.50	19.294	19.744	19.50
24	3.00	20.752	21.252	21.00
27	3.00	23.752	24.252	24.00
30	3.50	26.211	26.771	26.50
33	3.50	29.211	29.771	29.50
36	4.00	31.670	32.270	32.00
39	4.00	34.670	35.270	35.00
42	4.50	37.129	37.799	37.50
45	4.50	40.129	40.799	40.50
48	5.00	42.587	43.297	43.00
52	5.00	46.587	47.297	47.00
56	5.50	50.046	50.796	50.50



# KERNLOCHBOHRUNGEN – CORE HOLES

## MF DIN 13, ISO 261, 6H

Ø	P	Kern-Ø Mutter - Core Ø nut		Ø guide line
		Ø mini	Ø maxi	
d <sub>1</sub>	mm	Ø mini	Ø maxi	Ø guide line
27	1.50	25.376	25.676	25.50
27	2.00	24.835	25.210	25.00
28	1.00	26.917	27.153	27.00
28	1.50	26.376	26.676	26.50
28	2.00	25.835	26.210	26.00
30	1.00	28.917	29.153	29.00
30	1.50	28.376	28.676	28.50
30	2.00	27.835	28.210	28.00
32	1.50	30.376	30.676	30.50
32	2.00	29.835	30.210	30.00
33	1.50	31.376	31.676	31.50
33	2.00	30.835	31.210	31.00
35	1.50	33.376	33.676	33.50
36	1.50	34.376	34.676	34.50
36	2.00	33.835	34.210	34.00
36	3.00	32.752	33.252	33.00
39	1.50	37.376	37.676	37.50
39	2.00	36.835	37.210	37.00
39	3.00	35.752	36.252	36.00
40	1.50	38.376	38.676	38.50
40	2.00	37.835	38.210	38.00
40	3.00	36.752	37.252	37.00
42	1.50	40.376	40.676	40.50
42	2.00	39.835	40.210	40.00
42	3.00	38.752	39.252	39.00
45	1.50	43.376	43.676	43.50
45	2.00	42.835	43.210	43.00
45	3.00	41.752	42.252	42.00
48	1.50	46.376	46.676	46.50
48	2.00	45.835	46.210	46.00
48	3.00	44.752	45.252	45.00
50	1.50	48.376	48.676	48.50
50	2.00	47.835	48.210	48.00
50	3.00	46.752	47.252	47.00
52	1.50	50.376	50.676	50.50
52	2.00	49.835	50.210	50.00
52	3.00	48.752	49.252	49.00
55	2.00	52.835	53.210	53.00
60	2.00	57.835	58.210	58.00

## MF EN 60423:1994, 7H

Ø	P	Kern-Ø Mutter - Core Ø nut		Ø guide line
		Ø mini	Ø maxi	
d <sub>1</sub>	mm	Ø mini	Ø maxi	Ø guide line
8	1.00	6.917	7.217	7.00
10	1.00	8.917	9.217	9.00
12	1.50	10.376	10.751	10.50
16	1.50	14.376	14.751	14.50
20	1.50	18.376	18.751	18.50
25	1.50	23.376	23.751	23.50
32	1.50	30.376	30.751	30.50
40	1.50	38.376	38.751	38.50
63	1.50	61.376	61.751	61.50

## UNC ASME B1.1, 2B

Ø"	P	P	Kern-Ø Mutter - Core Ø nut		Ø guide line
			Ø mini	Ø maxi	
d <sub>1</sub>	TPI	mm	Ø mini	Ø maxi	Ø guide line
1	64	0.397	1.425	1.582	1.45
2	56	0.454	1.695	1.871	1.75
3	48	0.529	1.941	2.146	2.00
4	40	0.635	2.157	2.385	2.25
5	40	0.635	2.487	2.697	2.55
6	32	0.794	2.642	2.895	2.75
8	32	0.794	3.302	3.530	3.40
10	24	1.058	3.683	3.962	3.80
12	24	1.058	4.344	4.597	4.40
1/4"	20	1.270	4.979	5.257	5.10
5/16"	18	1.411	6.401	6.731	6.50
3/8"	16	1.588	7.798	8.153	8.00
7/16"	14	1.814	9.144	9.550	9.30
1/2"	13	1.954	10.592	11.023	10.80
9/16"	12	2.117	11.989	12.446	12.20
5/8"	11	2.309	13.386	13.868	13.60
3/4"	10	2.540	16.307	16.840	16.60
7/8"	9	2.822	19.177	19.761	19.50
1"	8	3.175	21.971	22.606	22.30
1 1/8"	7	3.629	24.638	25.349	25.00
1 1/4"	7	3.629	27.813	28.524	28.20
1 3/8"	6	4.233	30.353	31.115	30.80
1 1/2"	6	4.233	33.528	34.290	34.00
1 3/4"	5	5.080	38.964	39.827	39.50
2"	4.5	5.644	44.679	45.593	45.30

## UNJC ISO 3161:1999, 3B

Ø"	P	P	Kern-Ø Mutter - Core Ø nut		Ø guide line
			Ø mini	Ø maxi	
d <sub>1</sub>	TPI	mm	Ø mini	Ø maxi	Ø guide line
4	40	0.635	2.228	2.393	2.30
5	40	0.635	2.558	2.723	2.60
6	32	0.794	2.733	2.939	2.80
8	32	0.794	3.393	3.599	3.45
10	24	1.058	3.795	4.064	3.90
12	24	1.058	4.455	4.704	4.55
1/4"	20	1.270	5.113	5.387	5.20
5/16"	18	1.411	6.563	6.833	6.70
3/8"	16	1.588	7.978	8.255	8.10
7/16"	14	1.814	9.347	9.639	9.40
1/2"	13	1.954	10.798	11.095	10.90
9/16"	12	2.117	12.228	12.482	12.40
5/8"	11	2.309	13.627	13.904	13.80
3/4"	10	2.540	16.576	16.881	16.70

# KERNLOCHBOHRUNGEN – CORE HOLES

## UNF ASME B1.1, 2B

Ø"	P	P	Kern-Ø Mutter - Core Ø nut		Ø guide line
			Ø mini	Ø maxi	
d <sub>1</sub>	TPI	mm			
0	80	0.318	1.182	1.305	1.20
1	72	0.353	1.474	1.612	1.50
2	64	0.397	1.756	1.912	1.80
3	56	0.454	2.025	2.197	2.10
4	48	0.529	2.271	2.458	2.35
5	44	0.577	2.551	2.740	2.60
6	40	0.635	2.820	3.022	2.90
8	36	0.706	3.404	3.606	3.50
10	32	0.794	3.963	4.165	4.05
12	28	0.907	4.496	4.724	4.60
1/4"	28	0.907	5.360	5.588	5.50
5/16"	24	1.058	6.782	7.035	6.90
3/8"	24	1.058	8.382	8.636	8.50
7/16"	20	1.270	9.729	10.033	9.80
1/2"	20	1.270	11.329	11.607	11.40
9/16"	18	1.411	12.751	13.081	12.90
5/8"	18	1.411	14.351	14.681	14.50
3/4"	16	1.588	17.323	17.678	17.50
7/8"	14	1.814	20.270	20.675	20.40
1"	12	2.117	23.114	23.571	23.30
1 1/8"	12	2.117	26.289	26.746	26.50
1 1/4"	12	2.117	29.464	29.921	29.70
1 3/8"	12	2.117	32.639	33.096	32.80
1 1/2"	12	2.117	35.814	36.271	36.00

## UNJF ISO 3161:1999, 3B

Ø"	P	P	Kern-Ø Mutter - Core Ø nut		Ø guide line
			Ø mini	Ø maxi	
d <sub>1</sub>	TPI	mm			
0	80	0.318	1.217	1.298	1.25
1	72	0.353	1.511	1.603	1.55
2	64	0.397	1.798	1.902	1.85
3	56	0.454	2.073	2.189	2.10
4	48	0.529	2.329	2.466	2.35
5	44	0.577	2.614	2.764	2.65
6	40	0.635	2.888	3.053	2.95
8	36	0.706	3.480	3.663	3.55
10	32	0.794	4.054	4.255	4.10
12	28	0.907	4.602	4.816	4.70
1/4"	28	0.907	5.466	5.662	5.55
5/16"	24	1.058	6.906	7.109	7.00
3/8"	24	1.058	8.494	8.679	8.60
7/16"	20	1.270	9.876	10.084	10.00
1/2"	20	1.270	11.463	11.661	11.55
9/16"	18	1.411	12.913	13.122	13.05
5/8"	18	1.411	14.501	14.702	14.60
3/4"	16	1.588	17.506	17.722	17.60
7/8"	14	1.814	20.460	20.706	20.60
1"	12	2.117	23.340	23.594	23.50

## UNEF ASME B1.1, 2B

Ø"	P	P	Kern-Ø Mutter - Core Ø nut		Ø guide line
			Ø mini	Ø maxi	
d <sub>1</sub>	TPI	mm			
12	32	0.794	4.623	4.826	4.70
1/4"	32	0.794	5.487	5.689	5.60
5/16"	32	0.794	7.087	7.264	7.20
3/8"	32	0.794	8.662	8.864	8.75
7/16"	28	0.907	10.135	10.337	10.25
1/2"	28	0.907	11.710	11.938	11.85
9/16"	24	1.058	13.132	13.385	13.20
5/8"	24	1.058	14.732	14.986	14.80
11/16"	24	1.058	16.307	16.560	16.40
3/4"	20	1.270	17.679	17.957	17.80
13/16"	20	1.270	19.254	19.558	19.40
7/8"	20	1.270	20.854	21.132	21.00
1"	20	1.270	24.029	24.307	24.10

## UN ASME B1.1, 2B

Ø"	P	P	Kern-Ø Mutter - Core Ø nut		Ø guide line
			Ø mini	Ø maxi	
d <sub>1</sub>	TPI	mm			
5/16"	20	1.270	6.554	6.858	6.70
3/8"	20	1.270	8.154	8.432	8.30
9/16"	20	1.270	12.904	13.208	13.00
5/8"	20	1.270	14.504	14.782	14.60
1 1/8"	8	3.175	25.146	25.781	25.50
1 1/4"	8	3.175	28.321	28.956	28.70
1 3/8"	8	3.175	31.496	32.131	31.80
1 1/2"	8	3.175	34.671	35.306	35.00
1 5/8"	8	3.175	37.846	38.481	38.20
1 3/4"	8	3.175	41.021	41.656	41.40
1 7/8"	8	3.175	44.196	44.831	44.50
2"	8	3.175	47.371	48.006	47.70
2 1/4"	8	3.175	53.721	54.356	54.10
2 1/2"	8	3.175	60.071	60.706	60.40

## UNS ASME B1.1, 2B

Ø"	P	P	Kern-Ø Mutter - Core Ø nut		Ø guide line
			Ø mini	Ø maxi	
d <sub>1</sub>	TPI	mm			
10	36	0.706	4.064	4.216	4.10
10	40	0.635	4.141	4.292	4.20
10	56	0.454	4.344	4.445	4.40
1/4"	36	0.706	5.588	5.740	5.65
1/4"	40	0.635	5.665	5.816	5.70
1/4"	48	0.529	5.766	5.892	5.80
1/4"	56	0.454	5.868	5.969	5.90
5/16"	36	0.706	7.163	7.340	7.25
3/8"	36	0.706	8.763	8.940	8.80
7/16"	24	1.058	9.957	10.210	10.00
1/2"	24	1.058	11.557	11.811	11.60
1"	14	1.814	23.445	23.825	23.60

# KERNLOCHBOHRUNGEN – CORE HOLES

## G (BSP) DIN EN ISO 228

Ø"	P	P	Kern-Ø Mutter - Core Ø nut		Ø guide line
			Ø mini	Ø maxi	
d <sub>1</sub>	TPI	mm			
1/16"	28	0.907	6.561	6.843	6.75
1/8"	28	0.907	8.566	8.848	8.75
1/4"	19	1.337	11.445	11.890	11.60
3/8"	19	1.337	14.950	15.395	15.20
1/2"	14	1.814	18.631	19.172	18.90
5/8"	14	1.814	20.587	21.128	20.90
3/4"	14	1.814	24.117	24.658	24.40
7/8"	14	1.814	27.877	28.418	28.20
1"	11	2.309	30.291	30.931	30.70
1 1/8"	11	2.309	34.939	35.579	35.30
1 1/4"	11	2.309	38.952	39.592	39.30
1 3/8"	11	2.309	41.365	42.005	41.80
1 1/2"	11	2.309	44.845	45.485	45.20
1 3/4"	11	2.309	50.788	51.428	51.20
2"	11	2.309	56.656	57.296	57.00
2 1/4"	11	2.309	62.752	63.392	63.10
2 1/2"	11	2.309	72.226	72.866	72.60
3"	11	2.309	84.926	85.566	85.30

## W (BSW) BS 84, (DIN11 - 1970)

Ø"	P	P	Kern-Ø Mutter - Core Ø nut		Ø guide line
			Ø mini	Ø maxi	
d <sub>1</sub>	TPI	mm			
(3/32")	48				1.80
1/8"	40	0.635	2.362	2.591	2.50
(5/32")	32				3.10
3/16"	24	1.058	3.406	3.744	3.60
(7/32")	24				4.40
1/4"	20	1.270	4.724	5.156	4.90
5/16"	18	1.411	6.129	6.588	6.40
3/8"	16	1.588	7.493	7.988	7.70
7/16"	14	1.814	8.791	9.332	9.10
1/2"	12	2.117	9.987	10.589	10.30
5/8"	11	2.309	12.918	13.558	13.30
3/4"	10	2.540	15.799	16.484	16.20
7/8"	9	2.822	18.613	19.355	19.25
1"	8	3.175	21.336	22.149	21.90

## TR ISO 2901-2904, DIN 103, 7H

Ø	P	Kern-Ø Mutter - Core Ø nut		Ø guide line
		Ø mini	Ø maxi	
d <sub>1</sub>	mm			
10	2	8	8.236	8.20
12	3	9	9.315	9.25
14	3	11	11.315	11.25
16	4	12	12.375	12.25
18	4	14	14.375	14.25
20	4	16	16.375	16.25
22	5	17	17.450	17.25
24	5	19	19.450	19.25
26	5	21	21.450	21.25
28	5	23	23.450	23.25
30	6	24	24.500	24.25
32	6	26	26.500	26.25

## PG DIN 40430

Ø	P	P	Kern-Ø Mutter - Core Ø nut		Ø guide line
			Ø mini	Ø maxi	
d <sub>1</sub>	TPI	mm			
7	20	1.270	11.28	11.43	11.35
9	18	1.411	13.86	14.01	13.90
11	18	1.411	17.26	17.41	17.30
13.5	18	1.411	19.06	19.21	19.10
16	18	1.411	21.16	21.31	21.20
21	16	1.588	26.78	27.03	26.80
29	16	1.588	35.48	35.73	35.50
36	16	1.588	45.48	45.73	45.50
42	16	1.588	52.48	52.73	52.50
48	16	1.588	57.78	58.03	57.80

## S NIHS 06-10, 3G5H (Standardtoleranz - standard tol.)

Ø	P	Kern-Ø Mutter - Core Ø nut		Ø guide line
		Ø mini	Ø maxi	
d <sub>1</sub>	mm			
0.3	0.080	0.223	0.240	0.23
0.35	0.090	0.264	0.286	0.28
0.4	0.100	0.304	0.330	0.32
0.5	0.125	0.380	0.415	0.41
0.6	0.150	0.456	0.502	0.50
0.7	0.175	0.532	0.585	0.58
0.8	0.200	0.608	0.665	0.66
0.9	0.225	0.684	0.745	0.74
1	0.250	0.760	0.825	0.82
1.2	0.250	0.960	1.025	1.02
1.4	0.300	1.112	1.185	1.18

## SF NIHS 06-10, 3G5H (Standardtoleranz - standard tol.)

Ø	P	Kern-Ø Mutter - Core Ø nut		Ø guide line
		Ø mini	Ø maxi	
d <sub>1</sub>	mm			
1.4	0.200	1.208	1.265	1.26
1.6	0.200	1.408	1.465	1.46
1.8	0.200	1.608	1.665	1.66
2	0.200	1.808	1.865	1.86
2.2	0.200	2.008	2.065	2.06
2.2	0.250	1.960	2.025	2.02
2.5	0.200	2.308	2.365	2.36
2.5	0.250	2.260	2.325	2.32

## SL Safelock SL 15-01

Ø	P	Kern-Ø Mutter - Core Ø nut		Ø guide line
		Ø mini	Ø maxi	
d <sub>1</sub>	mm			
0.3	0.060	0.264	0.278	0.27
0.35	0.060	0.314	0.328	0.32
0.4	0.080	0.356	0.372	0.36
0.5	0.100	0.448	0.466	0.46
0.6	0.125	0.538	0.559	0.55
0.7	0.150	0.628	0.651	0.64
0.8	0.150	0.728	0.751	0.74
0.9	0.175	0.818	0.844	0.83
1	0.200	0.908	0.936	0.92
1.2	0.200	1.108	1.136	1.12
1.4	0.250	1.288	1.321	1.30



# AUSSENDURCHMESSER — TURNED DIAMETERS

## M DIN 13, ISO 261, \*6h / 6g

Ø	P	Aussen-Ø Bolzen Thread outside Ø		Ø guide line
		Ø mini	Ø maxi	
d <sub>1</sub>	mm			
*1	0.25	0.933	1.000	0.97
*1.1	0.25	1.033	1.100	1.07
*1.2	0.25	1.133	1.200	1.17
*1.4	0.30	1.325	1.400	1.36
1.6	0.35	1.496	1.581	1.54
1.7	0.35	1.596	1.681	1.64
1.8	0.35	1.696	1.781	1.74
2	0.40	1.886	1.981	1.93
2.2	0.45	2.080	2.180	2.13
2.3	0.40	2.186	2.300	2.23
2.5	0.45	2.380	2.480	2.43
2.6	0.45	2.480	2.600	2.53
3	0.50	2.874	2.980	2.92
3.5	0.60	3.354	3.479	3.41
4	0.70	3.838	3.978	3.91
4.5	0.75	4.338	4.478	4.40
5	0.80	4.826	4.976	4.90
6	1.00	5.794	5.974	5.88
7	1.00	6.794	6.974	6.88
8	1.25	7.760	7.972	7.87
9	1.25	8.760	8.972	8.87
10	1.50	9.732	9.968	9.85
11	1.50	10.732	10.968	10.85
12	1.75	11.701	11.966	11.83
14	2.00	13.682	13.962	13.82
16	2.00	15.682	15.962	15.82
18	2.50	17.623	17.958	17.79
20	2.50	19.623	19.958	19.79
22	2.50	21.623	21.958	21.79
24	3.00	23.577	23.952	23.76
27	3.00	26.577	26.952	26.76
30	3.50	29.522	29.947	29.73
33	3.50	32.522	32.947	32.73
36	4.00	35.465	35.940	35.70
39	4.00	38.465	38.940	38.70
42	4.50	41.437	41.937	41.69
45	4.50	44.437	44.937	44.69
48	5.00	47.399	47.929	47.66
52	5.00	51.399	51.929	51.66
56	5.50	55.365	55.925	55.65

## MF DIN 13, ISO 261, 6g

Ø	P	Aussen-Ø Bolzen Thread outside Ø		Ø guide line
		Ø mini	Ø maxi	
d <sub>1</sub>	mm			
8	1.00	7.794	7.974	7.88
9	0.75	8.838	8.978	8.90
9	1.00	8.794	8.974	8.88
10	0.75	9.838	9.978	9.90
10	1.00	9.794	9.974	9.88
10	1.25	9.760	9.972	9.86
11	0.75	10.838	10.978	10.90
11	1.00	10.794	10.974	10.88
12	1.00	11.794	11.974	11.88
12	1.25	11.760	11.972	11.86
12	1.50	11.732	11.968	11.85
14	1.00	13.794	13.974	13.88
14	1.25	13.760	13.972	13.86
14	1.50	13.732	13.968	13.85
15	1.00	14.794	14.974	14.88
15	1.50	14.732	14.968	14.85
16	1.00	15.794	15.974	15.88
16	1.50	15.732	15.968	15.85
17	1.00	16.794	16.974	16.88
17	1.50	16.732	16.968	16.85
18	1.00	17.794	17.974	17.88
18	1.50	17.732	17.968	17.85
18	2.00	17.682	17.962	17.82
20	1.00	19.794	19.974	19.88
20	1.50	19.732	19.968	19.85
20	2.00	19.682	19.962	19.82
22	1.00	21.794	21.974	21.88
22	1.50	21.732	21.968	21.85
22	2.00	21.682	21.962	21.82
24	1.00	23.794	23.974	23.88
24	1.50	23.732	23.968	23.85
24	2.00	23.682	23.962	23.82
25	1.00	24.794	24.974	24.88
25	1.50	24.732	24.968	24.85
25	2.00	24.682	24.962	24.82
27	1.00	26.794	26.974	26.88
27	1.50	26.732	26.968	26.85
27	2.00	26.682	26.962	26.82
28	1.00	27.794	27.974	27.88
28	1.50	27.732	27.968	27.85
28	2.00	27.682	27.962	27.82
30	1.00	29.794	29.974	29.88
30	1.50	29.732	29.968	29.85
30	2.00	29.682	29.962	29.82
30	3.00	29.577	29.952	29.76
32	1.50	31.732	31.968	31.85
32	2.00	31.682	31.962	31.82
33	1.50	32.732	32.968	32.85
33	2.00	32.682	32.962	32.82
33	3.00	32.577	32.952	32.76
35	1.50	34.732	34.968	34.85
36	1.50	35.732	35.968	35.85
36	2.00	35.682	35.962	35.82
36	3.00	35.577	35.952	35.76
39	1.50	38.732	38.968	38.85
39	2.00	38.682	38.962	38.82
39	3.00	38.577	38.952	38.76

## MF DIN 13, ISO 261, 6g

Ø	P	Aussen-Ø Bolzen Thread outside Ø		Ø guide line
		Ø mini	Ø maxi	
d <sub>1</sub>	mm			
2.5	0.35	2.396	2.481	2.44
3	0.35	2.896	2.981	2.94
3.5	0.35	3.396	3.481	3.44
4	0.50	3.874	3.980	3.93
4.5	0.50	4.374	4.480	4.43
5	0.50	4.874	4.980	4.93
5.5	0.50	5.374	5.480	5.43
6	0.75	5.838	5.978	5.90
7	0.75	6.838	6.978	6.90
8	0.75	7.838	7.978	7.90

# AUSSENDURCHMESSER — TURNED DIAMETERS

## MF DIN 13, ISO 261, 6g

Ø	P	Aussen-Ø Bolzen Thread outside Ø		Ø guide line
		Ø mini	Ø maxi	
d <sub>1</sub>	mm	Ø mini	Ø maxi	Ø guide line
40	1.50	39.732	39.968	39.85
40	2.00	39.682	39.962	39.82
40	3.00	39.577	39.952	39.76
42	1.50	41.732	41.968	41.85
42	2.00	41.682	41.962	41.82
42	3.00	41.577	41.952	41.76
45	1.50	44.732	44.968	44.85
45	2.00	44.682	44.962	44.82
45	3.00	44.577	44.952	44.76
48	1.50	47.732	47.968	47.85
48	2.00	47.682	47.962	47.82
48	3.00	47.577	47.952	47.76
50	1.50	49.732	49.968	49.85
50	2.00	49.682	49.962	49.82
50	3.00	49.577	49.952	49.76
52	1.50	51.732	51.968	51.85
52	2.00	51.682	51.962	51.82
52	3.00	51.577	51.952	51.76
52	4.00	51.465	51.940	51.70



## UNF ASME B.1.1, 2A

Ø"	P	P	Aussen-Ø Bolzen Thread outside Ø		Ø guide line
			Ø mini	Ø maxi	
d <sub>1</sub>	TPI	mm	Ø mini	Ø maxi	Ø guide line
0	80	0.318	1.431	1.511	1.47
1	72	0.353	1.751	1.838	1.79
2	64	0.397	2.073	2.169	2.12
3	56	0.454	2.393	2.496	2.44
4	48	0.529	2.713	2.827	2.77
5	44	0.577	3.036	3.157	3.10
6	40	0.635	3.356	3.484	3.42
8	36	0.706	4.006	4.145	4.08
10	32	0.794	4.651	4.803	4.73
12	28	0.907	5.296	5.461	5.38
1/4"	28	0.907	6.160	6.324	6.24
5/16"	24	1.058	7.727	7.909	7.82
3/8"	24	1.058	9.315	9.497	9.41
7/16"	20	1.270	10.874	11.079	10.98
1/2"	20	1.270	12.462	12.666	12.56
9/16"	18	1.411	14.031	14.251	14.14
5/8"	18	1.411	15.619	15.839	15.73
3/4"	16	1.588	18.774	19.011	18.89
7/8"	14	1.814	21.923	22.184	22.05
1"	12	2.117	25.065	25.354	25.21
1 1/8"	12	2.117	28.240	28.529	28.38
1 1/4"	12	2.117	31.415	31.704	31.56
1 3/8"	12	2.117	34.588	34.876	34.73
1 1/2"	12	2.117	37.763	38.051	37.91



## UNC ASME B.1.1, 2A

Ø"	P	P	Aussen-Ø Bolzen Thread outside Ø		Ø guide line
			Ø mini	Ø maxi	
d <sub>1</sub>	TPI	mm	Ø mini	Ø maxi	Ø guide line
1	64	0.397	1.743	1.838	1.79
2	56	0.454	2.066	2.169	2.12
3	48	0.529	2.383	2.496	2.44
4	40	0.635	2.695	2.824	2.76
5	40	0.635	3.026	3.154	3.09
6	32	0.794	3.333	3.484	3.41
8	32	0.794	3.991	4.142	4.07
10	24	1.058	4.618	4.800	4.71
12	24	1.058	5.279	5.461	5.37
1/4"	20	1.270	6.117	6.322	6.22
5/16"	18	1.411	7.687	7.907	7.80
3/8"	16	1.588	9.254	9.491	9.37
7/16"	14	1.814	10.816	11.076	10.95
1/2"	13	1.954	12.386	12.661	12.52
9/16"	12	2.117	13.958	14.246	14.10
5/8"	11	2.309	15.528	15.834	15.68
3/4"	10	2.540	18.677	19.004	18.84
7/8"	9	2.822	21.824	22.176	22.00
1"	8	3.175	24.969	25.349	25.16
1 1/8"	7	3.629	28.103	28.519	28.31
1 1/4"	7	3.629	31.278	31.694	31.49
1 3/8"	6	4.233	34.402	34.864	34.63
1 1/2"	6	4.233	37.577	38.039	37.81
1 3/4"	5	5.080	43.860	44.381	44.12
2"	4.5	5.644	50.168	50.726	50.45
2 1/4"	4.5	5.644	56.518	57.076	56.80
2 1/2"	4	6.350	62.817	63.421	63.12
2 3/4"	4	6.350	69.165	69.768	69.47
3"	4	6.350	75.515	76.118	75.82
3 1/4"	4	6.350	81.862	82.466	82.16
3 1/2"	4	6.350	88.212	88.816	88.51
3 3/4"	4	6.350	94.560	95.163	94.86
4"	4	6.350	100.910	101.513	101.21



## UNEF ASME B.1.1, 2A

Ø"	P	P	Aussen-Ø Bolzen Thread outside Ø		Ø guide line
			Ø mini	Ø maxi	
d <sub>1</sub>	TPI	mm	Ø mini	Ø maxi	Ø guide line
12	32	0.794	5.312	5.463	5.39
1/4"	32	0.794	6.173	6.324	6.25
5/16"	32	0.794	7.760	7.912	7.84
3/8"	32	0.794	9.348	9.499	9.42
7/16"	28	0.907	10.920	11.084	11.00
1/2"	28	0.907	12.507	12.672	12.59
9/16"	24	1.058	14.075	14.257	14.17
5/8"	24	1.058	15.662	15.844	15.75
11/16"	24	1.058	17.250	17.432	17.34
3/4"	20	1.270	18.812	19.016	18.91
13/16"	20	1.270	20.339	20.604	20.50
7/8"	20	1.270	21.987	22.191	22.09
15/16"	20	1.270	23.572	23.776	23.67
1"	20	1.270	25.159	25.364	25.26
1 1/8"	18	1.411	28.319	28.539	28.43
1 1/4"	18	1.411	31.491	31.711	31.60
1 1/2"	18	1.411	37.841	38.061	37.95



## UN ASME B.1.1, 2A

Ø"	P	P	Aussen-Ø Bolzen Thread outside Ø		Ø guide line
			Ø mini	Ø maxi	
d <sub>1</sub>	TPI	mm	Ø mini	Ø maxi	Ø guide line
5/16"	20	1.270	7.702	7.907	7.80
3/8"	20	1.270	9.289	9.494	9.39
9/16"	20	1.270	14.049	14.254	14.15
5/8"	20	1.270	15.637	15.841	15.74



# AUSSENDURCHMESSER — TURNED DIAMETERS

## UN ASME B1.1, 2A

Ø"	P	P	Aussen-Ø Bolzen Thread outside Ø		Ø guide line
			Ø mini	Ø maxi	
d <sub>1</sub>	TPI	mm			
1 1/8"	8	3.175	28.141	28.521	28.33
1 1/4"	8	3.175	31.316	31.696	31.51
1 3/8"	8	3.175	34.489	34.869	34.68
1 1/2"	8	3.175	37.664	38.044	37.85
1 5/8"	8	3.175	40.839	41.219	41.03
1 3/4"	8	3.175	44.011	44.391	44.20
1 7/8"	8	3.175	47.186	47.566	47.38
2"	8	3.175	50.361	50.741	50.55
2 1/4"	8	3.175	56.709	57.089	56.90
2 1/2"	8	3.175	63.059	63.439	63.25
2 3/4"	8	3.175	69.406	69.786	69.60
3"	8	3.175	75.753	76.133	75.94

## UNS ASME B1.1, 2A

Ø"	P	P	Aussen-Ø Bolzen Thread outside Ø		Ø guide line
			Ø mini	Ø maxi	
d <sub>1</sub>	TPI	mm			
10	36	0.706	4.664	4.803	4.73
10	40	0.635	4.674	4.803	4.74
10	56	0.454	4.705	4.808	4.76
1/4"	36	0.706	6.188	6.327	6.26
1/4"	40	0.635	6.198	6.327	6.26
1/4"	48	0.529	6.216	6.329	6.27
1/4"	56	0.454	6.226	6.329	6.28
5/16"	36	0.706	7.775	7.914	7.84
3/8"	36	0.706	9.360	9.499	9.43
7/16"	24	1.058	10.902	11.084	10.99
1/2"	24	1.058	12.487	12.669	12.58
1"	14	1.814	25.096	25.356	25.23

## G (BSP) DIN EN ISO 228

Ø"	P	P	Aussen-Ø Bolzen Thread outside Ø		Ø guide line
			Ø mini	Ø maxi	
d <sub>1</sub>	TPI	mm			
1/16"	28	0.907	7.509	7.723	7.62
1/8"	28	0.907	9.514	9.728	9.62
1/4"	19	1.337	12.907	13.157	13.03
3/8"	19	1.337	16.412	16.662	16.54
1/2"	14	1.814	20.671	20.955	20.81
5/8"	14	1.814	22.627	22.911	22.77
3/4"	14	1.814	26.157	26.441	26.30
7/8"	14	1.814	29.917	30.201	30.06
1"	11	2.309	32.889	33.249	33.07
1 1/8"	11	2.309	37.537	37.897	37.72
1 1/4"	11	2.309	41.550	41.910	41.73
1 3/8"	11	2.309	43.963	44.323	44.14
1 1/2"	11	2.309	47.443	47.803	47.62
1 3/4"	11	2.309	53.386	53.746	53.57
2"	11	2.309	59.254	59.614	59.43
2 1/4"	11	2.309	65.276	65.710	65.49
2 1/2"	11	2.309	74.750	75.184	74.97
2 3/4"	11	2.309	81.100	81.534	81.32
3"	11	2.309	87.450	87.884	87.67
3 1/2"	11	2.309	99.896	100.330	100.11

## W (BSW) BS 84

Ø"	P	P	Aussen-Ø Bolzen Thread outside Ø		Ø guide line
			Ø mini	Ø maxi	
d <sub>1</sub>	TPI	mm			
1/4"	20	1.270	6.165	6.319	6.24
5/16"	18	1.411	7.737	7.904	7.82
3/8"	16	1.588	9.312	9.489	9.40
7/16"	14	1.814	10.884	11.074	10.98
1/2"	12	2.117	12.456	12.662	12.56
5/8"	11	2.309	15.613	15.832	15.72
3/4"	10	2.540	18.771	19.004	18.89
7/8"	9	2.822	21.979	22.225	22.10
1"	8	3.175	25.138	25.400	25.27
1 1/8"	7	3.629	28.296	28.575	28.44
1 1/4"	7	3.629	31.465	31.750	31.61
1 1/2"	6	4.233	37.793	38.100	37.95
1 3/4"	5	5.080	44.117	44.450	44.28
2"	4.5	5.644	50.449	50.800	50.62
2 1/4"	4	6.350	56.779	57.150	56.96
2 1/2"	4	6.350	63.119	63.500	63.31

## TR ISO 2901-2904, DIN 103, 7e

Ø	P	Aussen-Ø Bolzen Thread outside Ø		Ø guide line
		Ø mini	Ø maxi	
d <sub>1</sub>	mm			
10	2	9.820	10.000	9.91
12	3	11.764	12.000	11.88
14	3	13.764	14.000	13.88
16	4	15.700	16.000	15.85
18	4	17.700	18.000	17.85
20	4	19.700	20.000	19.85
22	5	21.665	22.000	21.83
24	5	23.665	24.000	23.83
26	5	25.665	26.000	25.83
28	5	27.665	28.000	27.83
30	6	29.625	30.000	29.81
32	6	31.625	32.000	31.81

## PG DIN 40430

Ø	P	P	Aussen-Ø Bolzen Thread outside Ø		Ø guide line
			Ø mini	Ø maxi	
d <sub>1</sub>	TPI	mm			
7	20	1.270	12.3	12.5	12.40
9	18	1.411	15.0	15.2	15.10
11	18	1.411	18.4	18.6	18.50
13.5	18	1.411	20.2	20.4	20.30
16	18	1.411	22.3	22.5	22.40
21	16	1.588	28.0	28.3	28.15
29	16	1.588	36.7	37.0	36.85
36	16	1.588	46.7	47.0	46.85
42	16	1.588	53.7	54.0	53.85
48	16	1.588	59.0	59.3	59.15

Angebotsanfrage

Versuchsergebnis

Beanstandung

**Vertretung:** \_\_\_\_\_  
**Kunde:** \_\_\_\_\_  
**Tel.- /Fax-Nr.:** \_\_\_\_\_

**Kontaktperson:** \_\_\_\_\_  
**E-Mail:** \_\_\_\_\_  
**Datum:** \_\_\_\_\_

**1. Werkzeug-Typ:** \_\_\_\_\_  
**Besonderheit:** \_\_\_\_\_

**Abmessung:** \_\_\_\_\_  
**Toleranzklasse:** \_\_\_\_\_

**2. Werkstoffgruppe:** \_\_\_\_\_  
**Werkstoff-Nr.:** \_\_\_\_\_  
**Norm:** \_\_\_\_\_

**Härte:** \_\_\_\_\_ N/mm<sup>2</sup> / HB / HRC  
**Bruchdehnung:** \_\_\_\_\_ %

**3. Gewinde:**  Sackloch  Durchgangsloch  
**Kernloch-Ø:** \_\_\_\_\_  
**Aufbohrungs-Ø:** \_\_\_\_\_

**Gewindelänge:** \_\_\_\_\_ mm  
**Tiefe:** \_\_\_\_\_ mm  
**Tiefe:** \_\_\_\_\_ mm

**4. Schnittgeschwindigkeit (V<sub>c</sub>):** \_\_\_\_\_ m/min \_\_\_\_\_ 1/min  
**Vorschub (f):** \_\_\_\_\_ %

**5. Maschine:** \_\_\_\_\_  
**Arbeitsrichtung:**  horizontal  vertikal  
**Synchro-Gewindeschneiden:**  Soft-Rigidfutter  Spannzange  Weldon  Schrumpffutter

Innenkühlung  
 Längenausgleich  
 Ausklinkbar  
 Rutschkupplung  
 Automat. Umschaltung

**6. Schmierung:**  Emulsion  Schneidöl  Luft  MMS  
**Produkt:** \_\_\_\_\_

**7. Grund des Werkzeugwechsels:**  Werkzeugverschleiss  
 Gewinde nicht korrekt (kontrolliert mit Lehre)  
 Maschinenfehler

Werkzeugbruch  
 Zahnausbrüche im Anschnittbereich  
 Zahnausbrüche im Führungsgewinde

**8. Standzeitvergleich:**  
**Vergleichswerkzeug:** \_\_\_\_\_  
**Resultat und Befund:** \_\_\_\_\_

**Bemerkungen:** \_\_\_\_\_  
 \_\_\_\_\_

Enquiry

Test result

Complaint

**Agency:** \_\_\_\_\_  
**Customer:** \_\_\_\_\_  
**Phone or fax:** \_\_\_\_\_

**Contact:** \_\_\_\_\_  
**E-mail:** \_\_\_\_\_  
**Date:** \_\_\_\_\_

**1. Tool type:** \_\_\_\_\_  
**Particularity:** \_\_\_\_\_

**Thread size:** \_\_\_\_\_  
**Class of tolerance:** \_\_\_\_\_

**2. Material group:** \_\_\_\_\_  
**Material N°:** \_\_\_\_\_  
**Norm:** \_\_\_\_\_

**Hardness:** \_\_\_\_\_ N/mm<sup>2</sup> / HB / HRC  
**Elongation:** \_\_\_\_\_ %

**3. Thread:**       blind hole       through hole

**Threaded length:** \_\_\_\_\_ mm

**Core hole Ø:** \_\_\_\_\_

**Depth:** \_\_\_\_\_ mm

**Counter-bore Ø:** \_\_\_\_\_

**Depth:** \_\_\_\_\_ mm

**4. Cutting speed (V<sub>c</sub>):** \_\_\_\_\_ m/min      \_\_\_\_\_ 1/min

**Feed (f):** \_\_\_\_\_ %

**5. Machine:** \_\_\_\_\_  internal coolant

**Working position:**       horizontal

vertical

**Rigid Tapping:**       "Soft Rigid Tapping"

**Tapping spindle:**       axial compensation

collet

de-clutching

Weldon

reversible

hot / cold shrunk

sliding clutch

**6. Lubricant:**       emulsion

cutting oil

air

mist

**Product:** \_\_\_\_\_

**7. Tool change reason:**       tool wear

tool breakage

thread not correct (checked with thread plug gauge)

tooth breakage in the chamfer lead

machine error

tooth breakage in the guiding thread

**8. Efficiency comparison:**

**Tool under test:** \_\_\_\_\_

**Performance and observations:** \_\_\_\_\_

**Remarks:** \_\_\_\_\_  
 \_\_\_\_\_

**SIE FINDEN  
ALL DIESE WERKZEUGE IN UNSEREM **WEBSHOP**  
REGISTRIEREN SIE SICH JETZT: [DCSWISS.COM](http://DCSWISS.COM)**



**YOU FIND  
ALL THESE TOOLS ON OUR **WEBSHOP**  
REGISTER NOW: [DCSWISS.COM](http://DCSWISS.COM)**

## ZUSCHLÄGE — PRICE SUPPLEMENTS

### **Mögliche Abänderungen von blanken Standard-Gewindebohrern**

#### **Preis und Lieferfrist auf Anfrage**

Abändern des Spanwinkels (ab  $\varnothing$  5 mm)  
Schneidkanten-Konditionierung ( $\varnothing \leq 52$  mm)  
Verlängern des Anschnittes (ab  $\varnothing$  2.5 mm)  
Kürzen des Anschnittes (ab  $\varnothing$  2.5 mm)  
Schälanschnitt anschleifen (ab  $\varnothing$  5 mm)  
Abändern von l3, d2, a oder d4  
Verlängern der Nuten ( $\varnothing \geq 5$  mm -  $\leq 48$  mm)  
Abschleifen der Zentrierspitze ( $\varnothing \geq 1$  mm -  $\leq 12$  mm)  
Aussetzen der Zähne (ab Steigung 0.5 mm)  
Verjüngen des Führungsgewindes (ab  $\varnothing$  3 mm)  
Weldonfläche anschleifen ( $\varnothing \geq 6$  mm -  $\leq 16$  mm)  
Kühlkanal, mit stirnseitigem Schmiermittelaustritt ( $\varnothing \geq 3$  mm -  $\leq 25.4$  mm)  
Kühlkanal, mit seitlichem Schmiermittelaustritt ( $\varnothing \geq 3$  mm -  $\leq 25.4$  mm)  
NV-Plasmanitrierung + "V"-Oberflächenbehandlung  
DC-"V"-Oberflächenbehandlung  
Beschichtungen: TiN, TiCN, VS, CrN, HL, usw.  
Zusätzliche Markierung  
Kürzen des Spiralbohrerteils (N5951-SP; N5952-SP)

**Wir stellen natürlich auch kundenspezifische Gewindewerkzeuge nach Ihrer Zeichnung her.  
Preis und Lieferfrist auf Anfrage.**

### **Possible modifications of non-coated and non-surface treated standard taps**

#### **Price and delivery time on request**

Modification of cutting angle (from  $\varnothing$  5 mm)  
Conditioning of cutting edges ( $\varnothing \leq 52$  mm)  
Lengthening of chamfer (from  $\varnothing$  2.5 mm)  
Shortening of chamfer (from  $\varnothing$  2.5 mm)  
Grinding of peeling cut (from  $\varnothing$  5 mm)  
Modification of l3, d2, a or d4  
Lengthening of flutes ( $\varnothing \geq 5$  mm -  $\leq 48$  mm)  
Removal of center point ( $\varnothing \geq 1$  mm -  $\leq 12$  mm)  
Interrupted thread (from pitch 0.5 mm)  
Truncated thread (from  $\varnothing$  3 mm)  
Grinding the Weldon Surface ( $\varnothing \geq 6$  mm -  $\leq 16$  mm)  
Internal coolant, with frontal outflow ( $\varnothing \geq 3$  mm -  $\leq 25.4$  mm)  
Internal coolant, with radial outflow ( $\varnothing \geq 3$  mm -  $\leq 25.4$  mm)  
NV-Plasma nitriding + "V" surface treatment  
DC "V" surface treatment  
Coatings: TiN, TiCN, VS, CrN, HL, etc.  
Additional marking  
Shortening of drill section (N5951-SP; N5952-SP)

**Of course we also produce customised threading tools as per your drawings.  
Price and delivery time on request.**



# LIEFER- UND ZAHLUNGSBEDINGUNGEN

<b>Bestellungen</b>	<p>Bestellungen, die nicht ab Lager ausgeliefert werden können, sind von uns zu bestätigen.</p> <p>Artikel, die nicht mehr standardmässig hergestellt werden, obwohl sie im Katalog aufgeführt sind, müssen als Spezialanfertigung angeboten und berechnet werden.</p> <p>Aufträge können nur nach gegenseitiger schriftlicher Abmachung annulliert werden.</p>
<b>Angebote und Auftragsbestätigungen</b>	<p>Die zu unseren Angeboten gehörenden Beschreibungen und Unterlagen, wie Gewichts- und Massangaben, Abbildungen und Zeichnungen, sind durch die ständige Weiterentwicklung nur annähernd massgebend, sofern sie nicht als verbindlich bezeichnet sind.</p>
<b>Preise</b>	<p>Unsere Preise verstehen sich exklusive MWSt, für Lieferung ab Werk, ausschliesslich Verpackung, Versandkosten und Versicherung.</p> <p>Im Falle einer Preiserhöhung behalten wir uns das Recht vor, bereits bestätigte Werkzeuge zu den neuen Preisen zu verrechnen.</p>
<b>Zahlungen</b>	<p>Unsere Rechnungen sind innert 30 Tagen netto zahlbar. Bei Zielüberschreitungen werden Verzugszinsen nach dem jeweils gültigen Diskontsatz verrechnet. Die Kosten für Lieferungen per Nachnahme, Wechselspesen, usw. gehen zu Lasten des Käufers.</p>
<b>Eigentumsvorbehalt</b>	<p>Wir behalten uns das Eigentum an der jeweils gelieferten Ware bis zur vollständigen Bezahlung des Kaufpreises, einschliesslich aller Nebenkosten, vor.</p>
<b>Versand</b>	<p>Erfolgt auf Rechnung und Gefahr des Bestellers.</p>
<b>Lieferfristen</b>	<p>Die Lieferfristen werden jeweils sorgfältig ermittelt, sind jedoch stets ohne Gewähr. Bei Überschreitung der bestätigten Lieferfrist lehnen wir Verzugsstrafen oder sonstige Schadenersatzforderungen, sowie Rücktritt von Bestellungen, grundsätzlich ab.</p>
<b>Spezialanfertigungen</b>	<p>Bei allen Lieferungen von Spezialwerkzeugen behalten wir uns das Recht einer Über- oder Unterschreitung der Bestellmenge um bis zu 15 %, bei kleinen Mengen um 1 bis 2 Stück, vor.</p>
<b>Garantie</b>	<p>Werkzeuge, die wir als fehlerhaft anerkennen, werden gratis ersetzt. Dies jedoch ohne jegliche weitere Entschädigung.</p>
<b>Beanstandungen</b>	<p>Beanstandungen müssen spätestens innert 14 Tagen nach Erhalt der Ware schriftlich angebracht werden.</p>
<b>Zeichnungen und Abbildungen</b>	<p>Es ist untersagt, Zeichnungen und Abbildungen zu kopieren oder Dritten zugänglich zu machen.</p> <p>Angaben in unserem Katalog, auf Zeichnungen und in anderen Dokumenten können sich infolge technischer Weiterentwicklung und eventueller neuer Normen ändern. Sie sind deshalb nicht verbindlich.</p>
<b>Notstandsbedingungen</b>	<p>In Fällen von höherer Gewalt, teilweisem oder totalem Unterbruch unserer Fabrikation, behalten wir uns das Recht vor, von eingegangenen Lieferverpflichtungen ganz oder teilweise zurückzutreten.</p>
<b>Erfüllungsort und Gerichtsstand</b>	<p>Für alle sich aus dem Vertragsverhältnis ergebenden Streitigkeiten ist das Amtsgericht Moutier (Schweiz) zuständig.</p> <p>Streitigkeiten unterstehen ausschliesslich dem Schweizerischen Obligationenrecht.</p>



## DELIVERY AND PAYMENT CONDITIONS

<b>Orders</b>	Orders, which cannot be delivered from stock, will be acknowledged. Items, which do not belong any more to our standard programme, although still featured in the catalogue, will be invoiced as «specials». Orders may only be cancelled by mutual written agreement.
<b>Quotations and acknowledgements</b>	For reasons of constant development in this field, all descriptions mentioned in our quotations, annexed documents, weight indications, measurements as well as illustrations and drawings are approximate indications. These technical data have binding value only if expressly specified.
<b>Prices</b>	Our prices are quoted for deliveries ex works Malleray, excluding VAT, packing, insurance, freight, customs' and legalisation duties. Should prices increase, we reserve the right to invoice tools already acknowledged at the new prices.
<b>Payment</b>	Payments must be made in advance or against irrevocable and confirmed documentary credit to be opened in our favour with a Swiss bank. All banking commissions and charges have to be borne by the buyer.
<b>Right of ownership</b>	We reserve the right of ownership of all goods supplied until the sales price, plus all incidental charges, have fully been paid.
<b>Despatch</b>	Deliveries take place at the purchaser's risk.
<b>Delivery</b>	Confirmed delivery dates are non-binding. We will do our utmost to maintain them. However, we cannot accept responsibility of direct or consequential losses due to delayed deliveries.
<b>Special orders</b>	For all special tools we reserve the right to over or under supply the ordered quantity by up to 15 %, or on small quantities by 1 or 2 pieces.
<b>Guarantee</b>	Tools recognised to be defective by DC will be replaced free of charge, but without prejudice.
<b>Complaints</b>	Complaints will be considered only within 15 days after receipt of the goods.
<b>Drawings and sketches</b>	The reproduction or transmission of drawings and other documents to a third party are prohibited. The information (drawings and prints) in our catalogue is for guidance only and is not binding.
<b>Special conditions</b>	In the case of partial or total disruption of our production; we reserve the right to partially or totally cancel our delivery commitments.
<b>Tribunal</b>	All disputes are subject to Swiss Law. The seat of court of law will be Moutier (Switzerland).

# DC PROGRAMME OVERVIEW

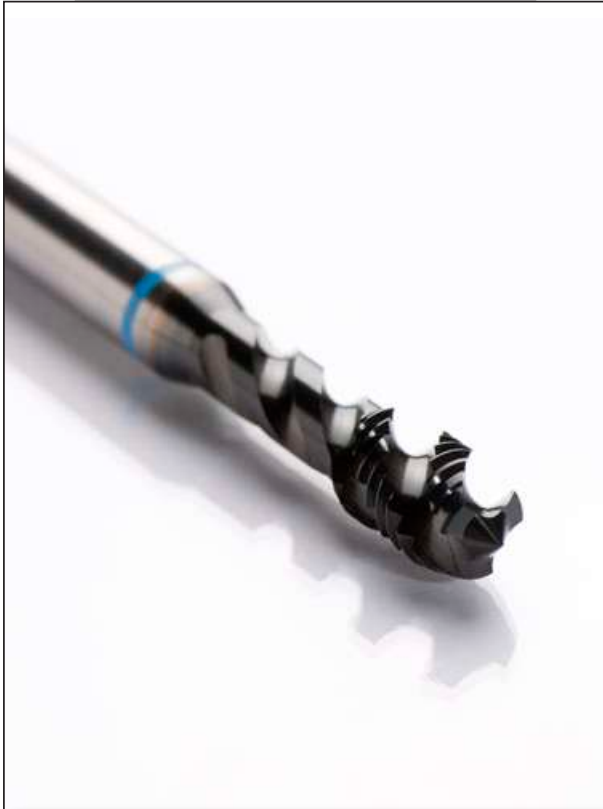

THREAD CUTTING



THREAD FORMING



RIGID TAPPING



TAPPING CHUCKS



THREAD WHIRLING



THREAD MILLING



THREAD DIES



THREAD GAUGES



Schweizerische Eidgenossenschaft  
Confédération suisse  
Confederazione Svizzera  
Confederaziun svizra

Federal Department of Economic Affairs,  
Education and Research EAER  
**State Secretariat for Economic Affairs SECO**  
Swiss Accreditation Service SAS

Swiss Confederation

Based on the Accreditation and Designation Ordinance dated 17 June 1996 and on the advice of the Federal Accreditation Commission, the Swiss Accreditation Service (SAS) grants to

**DC NANO TOOLS SA**  
**Métrologie**  
**Grand-rue 19**  
**2735 Malleray**



**Period of accreditation:**  
**06.01.2021 until 05.01.2026**  
(1st accreditation: 06.01.2016)

the accreditation as

**Calibration laboratory for Length**

International standard: ISO/IEC 17025:2017  
Swiss standard: SN EN ISO/IEC 17025:2018

3003 Berne, 17.11.2020  
Swiss Accreditation Service SAS

Head of SAS  
Konrad Flück

SAS is a signatory of the multilateral agreements of the European co-operation for Accreditation (EA) for the fields of testing, calibration, inspection and certification of management systems, certification of personnel and certification of products, processes and services, of the International Accreditation Forum (IAF) for the fields of certification of management systems and certification of products, processes and services and of the International Laboratory Accreditation Cooperation (ILAC) for the fields of testing and calibration.

Certificate of the Swiss Private Sector Energy Agency

# Voluntary Climate Protection and Energy Efficiency

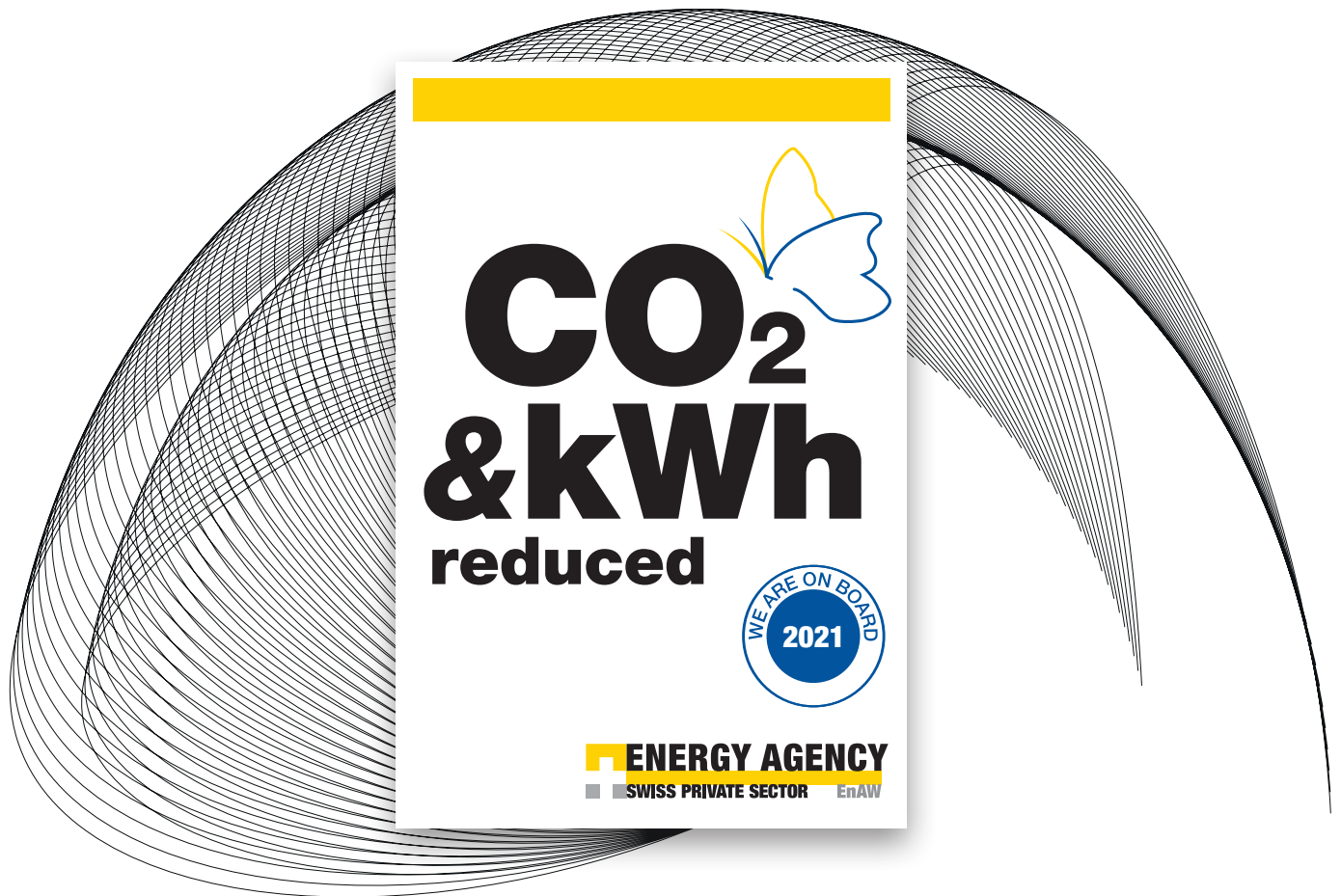

## DC Swiss SA

DC Swiss SA is convinced of the need to stand up for sustainable climate protection. By voluntarily declaring its adherence to the Swiss Private Sector Energy Agency programme, DC Swiss SA commits to actively reducing CO<sub>2</sub> emissions and optimizing energy efficiency. The Swiss Federal Government, cantons and private sector partners honor the target agreement.

  
Dr. Jacqueline Jakob  
Swiss Private Sector Energy Agency

1<sup>st</sup> January 2021

  
Martin Kernen  
Swiss Private Sector Energy Agency

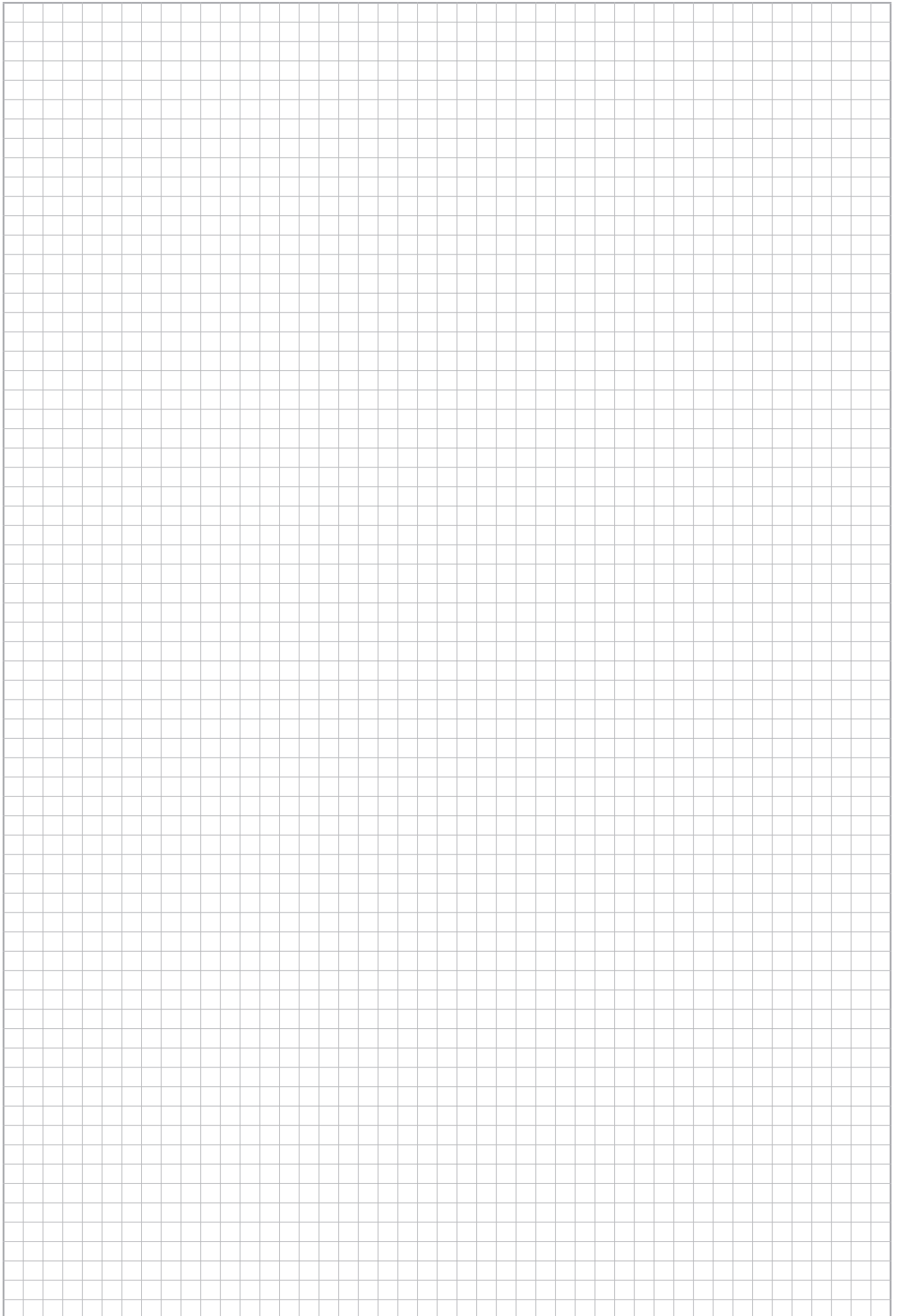

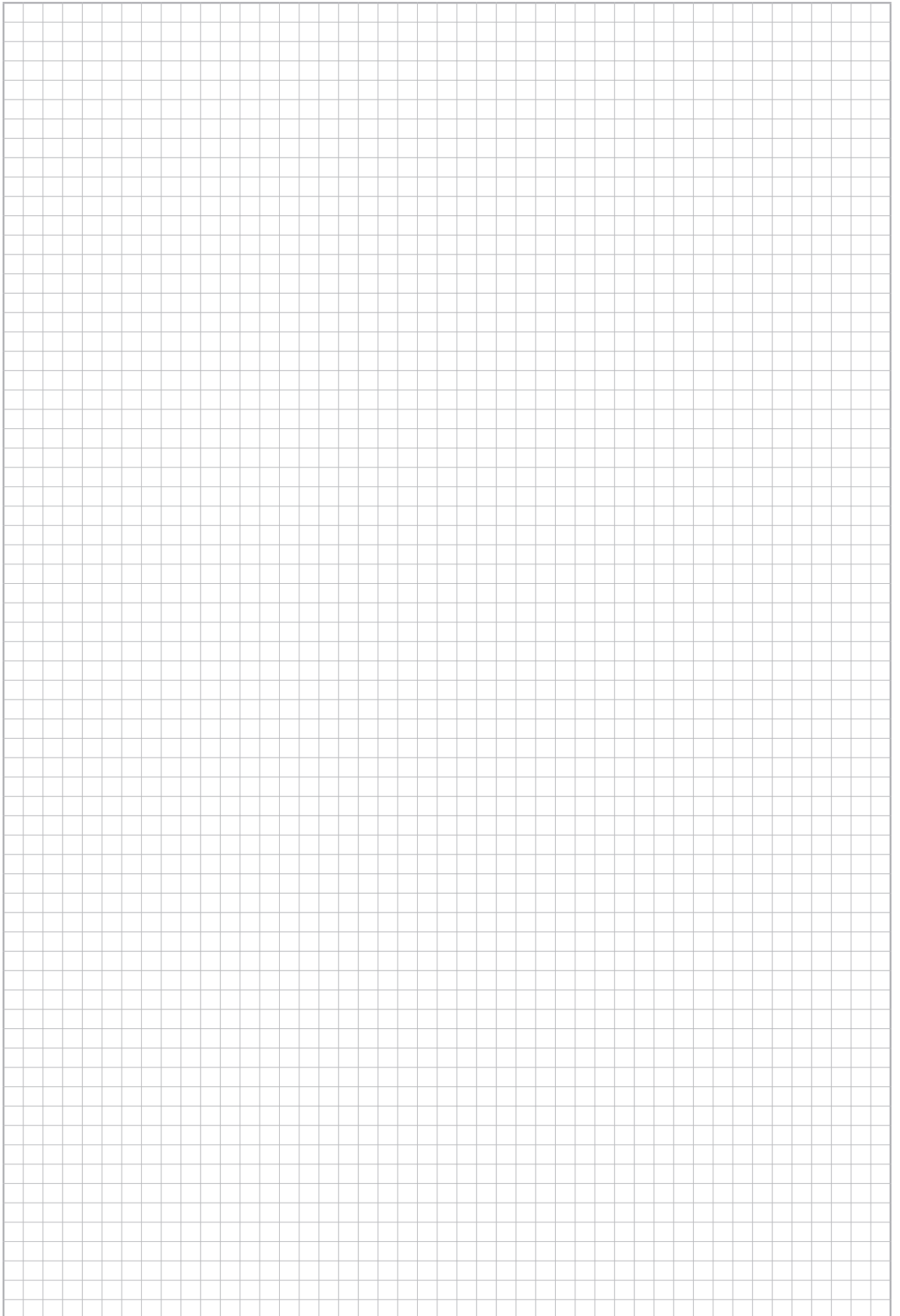



SRT 520 DC SYNCHRO

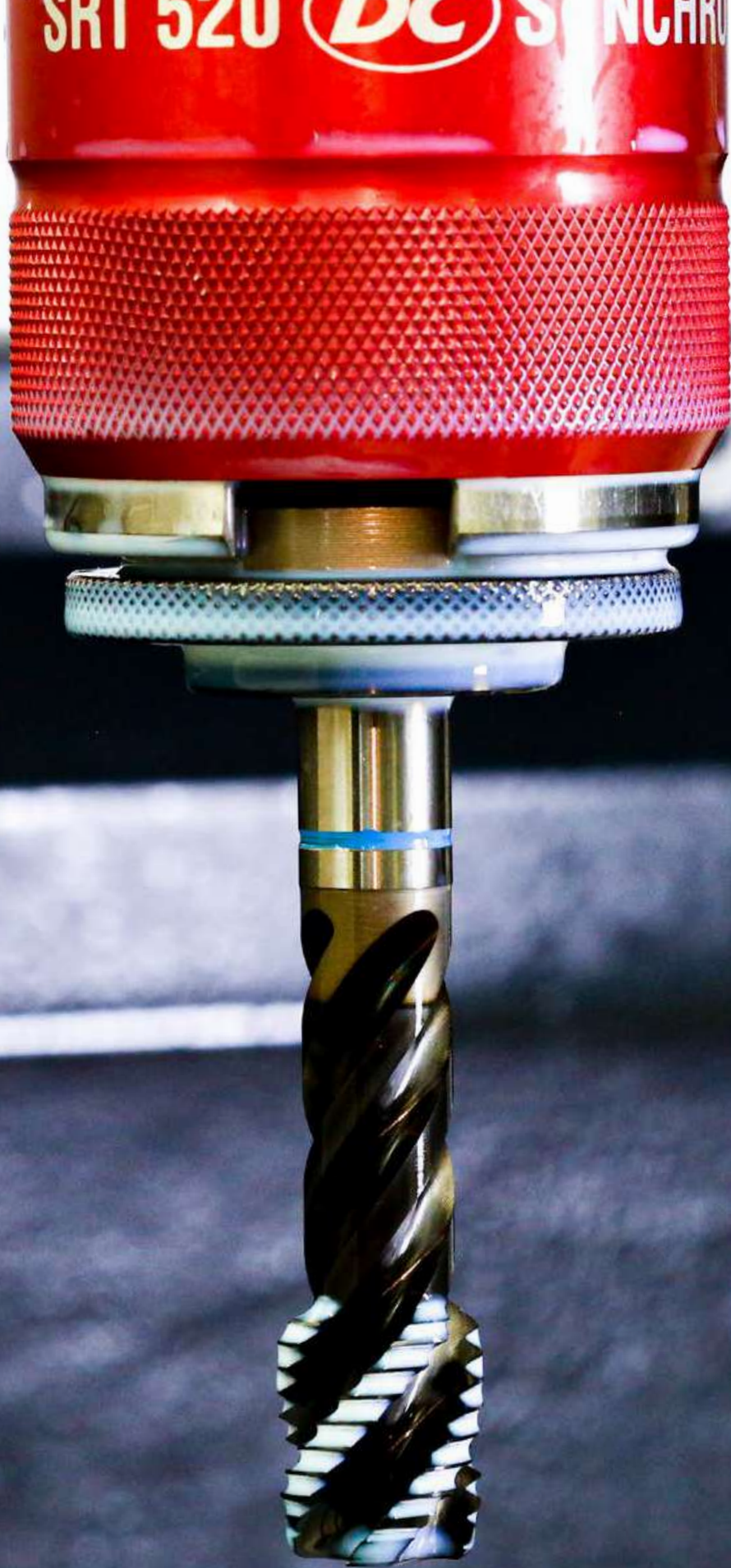





**DC SWISS SA**  
Grand-Rue 19  
CH-2735 Malleray  
Tel. + 41 32 491 63 63  
info@dcswiss.ch



**DC Nano Tools SA**  
Grand-Rue 19  
CH-2735 Malleray  
Tel. + 41 32 491 63 63  
info@dcswiss.ch

**DC Swiss GmbH**  
Graseggerstrasse 125  
DE-50737 Köln  
Tel. + 49 221 995 532 0  
info@dcswiss.de

**DC Swiss s.r.l**  
Via Canova 10  
IT-20017 Rho  
Tel. + 39 02 669 40 41  
info@dcswiss.it

**DC Swiss UK Ltd**  
9 Orgreave Road  
GB-Sheffield S13 9LQ  
Tel. + 44 114 293 90 13  
info@dcswiss.co.uk



[dcswiss.com](http://dcswiss.com)



### **WARNUNG**

*Gewindewerkzeuge können durch technisches Versagen oder durch Fahrlässigkeit brechen oder zersplittern und die Gesundheit des Mitarbeitenden gefährden. Befolgen Sie daher die gesetzlichen Sicherheits- und Gesundheitsvorschriften. Zudem ist das Tragen der Schutzbrille unerlässlich.*

*Das Schleifen von Gewindewerkzeugen verursacht gefährlichen Staub und darf nur unter gewissenhaftesten Sicherheitsrichtlinien verrichtet werden.*

### **WARNING**

Thread tools can break or shatter either through technical failure or negligence, and can endanger the health of the operator. Always obey the safety and health regulations, also the wearing of safety glasses is compulsory.

The grinding of threading tools causes hazardous particles, and must be performed only under most rigorous safety standards.

*Eventuelle Änderungen oder Anpassungen der technischen Daten sowie Druckfehler berechtigen zu keinerlei Entschädigung.*

*Die Wiedergabe von Texten oder Bildern, auch auszugsweise, ist nicht gestattet.*

We have made every effort to ensure that the information (drawings, prints, technical data) given is correct. However, we do not assume any responsibility for any errors, omissions or subsequent changes.

The reproduction of drawings and other documents and their transmission to a third party is prohibited.

*Mit dem Erscheinen dieses Kataloges werden alle früheren Ausgaben ungültig (Ausnahme: Katalog TM.1)!*

The publication of this catalogue renders all previous editions obsolete (exception: catalogue TM.1)!



**DC SWISS SA**  
Grand-Rue 19  
CH-2735 Malleray  
Tel. + 41 32 491 63 63  
info@dcswiss.ch

**DC Nano Tools SA**  
Grand-Rue 19  
CH-2735 Malleray  
Tel. + 41 32 491 63 63  
info@dcswiss.ch

 **SWISSQUALITY**



**DC Swiss GmbH**  
Graseggerstrasse 125  
DE-50737 Köln  
Tel. + 49 221 995 532 0  
info@dcswiss.de

**DC Swiss s.r.l**  
Via Canova 10  
IT-20017 Rho  
Tel. + 39 02 669 40 41  
info@dcswiss.it

**DC Swiss UK Ltd**  
9 Orgreave Road  
GB-Sheffield S13 9LQ  
Tel. + 44 114 293 90 13  
info@dcswiss.co.uk