

**CHIA-MO**

WWW.CHIAMO.IT

I T A L Y

MANDRINI PORTA PINZE ER DIN 6499  
ER DIN 6499 COLLET TYPE DRILL HOLDERS



**10**

# MANDRINI PORTA PINZE ER DIN 6499 ER DIN 6499 COLLET TYPE DRILL HOLDERS

I mandrini porta pinza ER DIN 6499 vengono utilizzati su un'ampia gamma di macchine da produzione per il bloccaggio degli utensili. Sono disponibili con ghiera standard o mini e con o senza piano di serraggio. Chia-mo produce inoltre mandrini porta pinza con doppia sede per lavorare sia sul mandrino principale che sul contro-mandrino del tornio.

## Descrizione e specifiche

I mandrini porta pinza ER DIN 6499 sono costruiti con acciaio certificato altamente legato, sono temprati e completamente rettificati. Tutto il ciclo produttivo viene svolto nel nostro stabilimento in Italia con macchine utensili di alta precisione ed è rigorosamente controllato. Grazie all'ampia disponibilità di magazzino possiamo generalmente spedire il materiale il giorno stesso della ricezione dell'ordine.

## Maggiori informazioni

Possono essere forniti con attacco con morse, attacco cilindrico metrico e in pollici e attacco Vdi. Possiamo inoltre eseguire mandrini porta pinza ER DIN 6499 speciali su richiesta del cliente.

## Prodotti

Mandrini porta pinza ER DIN 6499 – Mandrini porta pinza con ghiera standard – Mandrini porta pinza con ghiera mini – Mandrini porta pinza doppi – Mandrini porta pinza con attacco con morse – Mandrini porta pinza con attacco VDI DIN 69880.

ER DIN 6499 collet type drill holders are used on a broad range of production machines for tool clamping. They are available with standard or mini nut and with or without clamping flat.

Chia-mo also produces collet type drill holders with double seated dual headquarters to work on both the main spindle and on the counter-spindle lathe.

## Description and Specifications

ER DIN 6499 collet type drill holders are produced with certified top quality steel, they are hardened and completely grinded. All production cycle is carried out in our factory in Italy with high precision machines and is carefully controlled. Thanks to the availability of stock, we can usually ship the material the same day as order is received.

## Further Information

They can be supplied with vice taper fitting, metric and inch cylindrical shaft fitting and Vdi fitting. We can also produce special ER DIN 6499 collet type drill holders on request.

## Products

ER DIN 6499 collet type drill holders – Collet spindle with standard nut – Collet spindle with mini nut – Collet spindle with double seat – Morse taper shank collet chuck – Collet spindle with VDI DIN 69880 fitting. – Drilling heads.



**MANDRINI DOPPI PORTA PINZE Tipo 159 CON GHIERA MINI**

**DOUBLE - SEATED COLLET SPINDLES WITH MINI CLAMPING NUT**



Art. / Code	d	L	H	D	Pinza / Collet	Fig.
159.716 040	16	40	71	16	ERC 11	1
159.716 068	16	68	99	16	ERC 11	1

**ERC 11**

**Pinze DIN 6499/B**  
 Collets DIN 6499/B

159.719 042	19.05	42	70	16	ERC 11	1
159.719 052	19.05	52	80	16	ERC 11	1
159.719 062	19.05	62	90	16	ERC 11	1
159.719 092	19.05	92	120	16	ERC 11	1
159.719 102	19.05	102	130	16	ERC 11	1
159.719 112	19.05	112	140	16	ERC 11	1

159.720 042	20	42	70	16	ERC 11	1
159.720 052	20	52	80	16	ERC 11	1
159.720 062	20	62	90	16	ERC 11	1
159.720 070	20	70	98	16	ERC 11	1

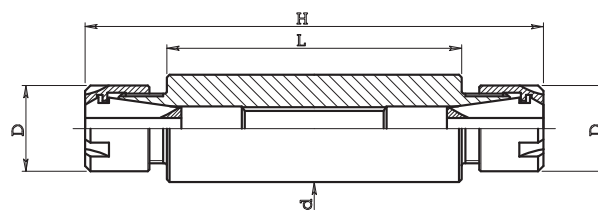

Fig. 1

Art. / Code	d	L	H	D	Pinza / Collet	Fig.
159.019 037	19.05	37	80	22	ERC 16	2
159.019 057	19.05	57	100	22	ERC 16	2
159.019 067	19.05	67	110	22	ERC 16	2

**ERC 16**

159.020 037	20	37	80	22	ERC 16	2
159.020 057	20	57	100	22	ERC 16	2
159.020 067	20	67	110	22	ERC 16	2
159.020 122	20	122	165	22	ERC 16	2

159.022 027	22	27	70	22	ERC 16	1
159.022 047	22	47	90	22	ERC 16	1
159.022 067	22	67	110	22	ERC 16	1
159.022 102	22	102	145	22	ERC 16	1
159.022 122	22	122	165	22	ERC 16	1

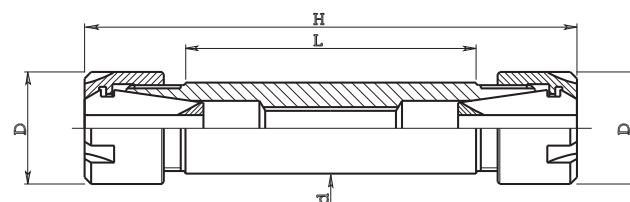

Fig. 2

159.023 070	23	70	113	22	ERC 16	1
159.023 090	23	90	133	22	ERC 16	1

159.025 027	25	27	70	22	ERC 16	1
159.025 047	25	47	90	22	ERC 16	1
159.025 067	25	67	110	22	ERC 16	1

159.026 027	25.40	27	70	22	ERC 16	1
159.026 047	25.40	47	90	22	ERC 16	1
159.026 067	25.40	67	110	22	ERC 16	1

Art. / Code	d	L	H	D	Pinza / Collet	Fig.
159.125 082	25	82	130	28	ERC 20	2

**ERC 20**

159.126 082	25.40	82	130	28	ERC 20	2
-------------	-------	----	-----	----	--------	---

159.132 057	32	57	105	28	ERC 20	1
159.132 082	32	82	130	28	ERC 20	1

Art. / Code	d	L	H	D	Pinza / Collet	Fig.
159.232 082	32	82	134	35	ERC 25	2

**ERC 25**

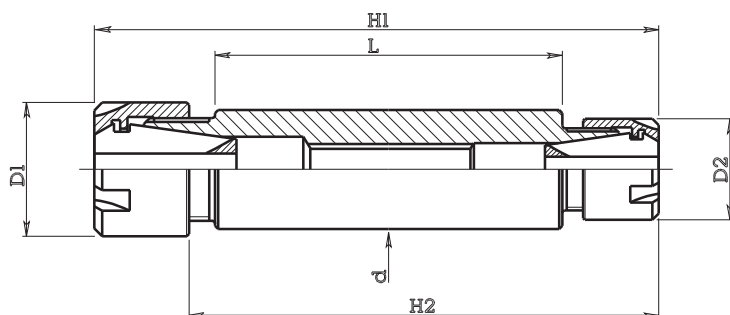
**MANDRINI DOPPI PORTA PINZE Tipo 158 CON GHIERA MINI**
**DOUBLE - SEATED COLLET SPINDLES WITH MINI CLAMPING NUT**

**Pinze DIN 6499/B**  
 Collets DIN 6499/B

Art. / Code	d	L	H1	H2	D1	Pinza 1 / Collet 1	D2	Pinza 2 / Collet 2
158.019 050	19.05	50	85	68	22	ERC 16	16	ERC 11
158.020 050	20	50	85	68	22	ERC 16	16	ERC 11
158.022 097	22	97	132	115	22	ERC 16	16	ERC 11

**ERC 16 - ERC 11**

Art. / Code	d	L	H1	H2	D1	Pinza 1 / Collet 1	D2	Pinza 2 / Collet 2
158.119 050	19.05	50	91	72	28	ERC 20	16	ERC 11
158.120 050	20	50	91	72	28	ERC 20	16	ERC 11
158.122 045	22	45	90	71	28	ERC 20	22	ERC 16
158.122 060	22	60	105	86	28	ERC 20	22	ERC 16

**ERC 20 - ERC 11**
**ERC 20 - ERC 16**

158.125 045	25	45	90	71	28	ERC 20	22	ERC 16
158.125 060	25	60	105	86	28	ERC 20	22	ERC 16

Art. / Code	d	L	H1	H2	D1	Pinza 1 / Collet 1	D2	Pinza 2 / Collet 2
158.225 045	25	45	91	71	35	ERC 25	22	ERC 16
158.225 060	25	60	106	86	35	ERC 25	22	ERC 16

**ERC 25 - ERC 16**

Art. / Code	d	L	H1	H2	D1	Pinza 1 / Collet 1	D2	Pinza 2 / Collet 2
158.232 060	32	60	108	88	35	ERC 25	28	ERC 20

**ERC 25 - ERC 20**

**MANDRINI PORTA PINZE Tipo 162 e 161 CON GHIERA MINI**  
COLLET SPINDLES WITH MINI CLAMPING NUT

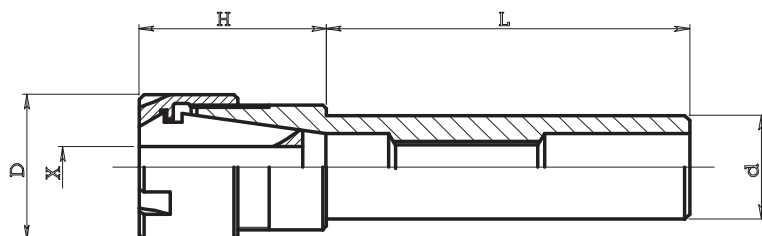

**Pinze DIN 6499/B**  
Collets DIN 6499/B

Art. / Code	d	L	H	D	X	Pinza / Collet	Art. pinza / Collet code	Art. ghiera / Nut code	Art. chiave / Spanner code
<b>162.805 045</b>	5	45	22	12	0.5 - 5	ERC 8	<b>050.008</b>	<b>052.108</b>	<b>053.108</b>
<b>162.806 045</b>	6	45	22	12	0.5 - 5	ERC 8	<b>050.008</b>	<b>052.108</b>	<b>053.108</b>
<b>162.808 055</b>	8	55	22	12	0.5 - 5	ERC 8	<b>050.008</b>	<b>052.108</b>	<b>053.108</b>
<b>162.808 080</b>	8	80	22	12	0.5 - 5	ERC 8	<b>050.008</b>	<b>052.108</b>	<b>053.108</b>
<b>162.808 100</b>	8	100	22	12	0.5 - 5	ERC 8	<b>050.008</b>	<b>052.108</b>	<b>053.108</b>
<b>162.810 055</b>	10	55	20	12	0.5 - 5	ERC 8	<b>050.008</b>	<b>052.108</b>	<b>053.108</b>
<b>162.810 080</b>	10	80	20	12	0.5 - 5	ERC 8	<b>050.008</b>	<b>052.108</b>	<b>053.108</b>
<b>162.812 100</b>	12	100	20	12	0.5 - 5	ERC 8	<b>050.008</b>	<b>052.108</b>	<b>053.108</b>
<b>162.813 100</b>	12.7	100	20	12	0.5 - 5	ERC 8	<b>050.008</b>	<b>052.108</b>	<b>053.108</b>

ERC 8

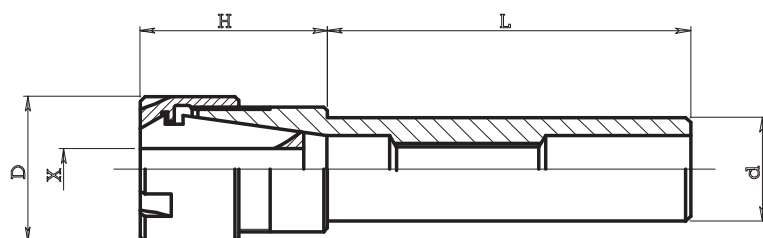
**MANDRINI PORTA PINZE Tipo 162 e 161 CON GHIERA MINI**
**COLLET SPINDLES WITH MINI CLAMPING NUT**

**Pinze DIN 6499/B**  
 Collets DIN 6499/B

Art. / Code	d	L	H	D	X	Pinza / Collet	Art. pinza / Collet code	Art. ghiera / Nut code	Art. chiave / Spanner code
<b>162.706 045</b>	6	45	26	16	0.5 - 7	ERC 11	<b>050.011</b>	<b>052.111</b>	<b>053.111</b>
<b>162.707 045</b>	7	45	26	16	0.5 - 7	ERC 11	<b>050.011</b>	<b>052.111</b>	<b>053.111</b>
<b>162.708 055</b>	8	55	26	16	0.5 - 7	ERC 11	<b>050.011</b>	<b>052.111</b>	<b>053.111</b>
<b>162.708 100</b>	8	100	26	16	0.5 - 7	ERC 11	<b>050.011</b>	<b>052.111</b>	<b>053.111</b>
<b>162.710 055</b>	10	55	26	16	0.5 - 7	ERC 11	<b>050.011</b>	<b>052.111</b>	<b>053.111</b>
<b>162.710 100</b>	10	100	26	16	0.5 - 7	ERC 11	<b>050.011</b>	<b>052.111</b>	<b>053.111</b>
<b>162.712 070</b>	12	70	26	16	0.5 - 7	ERC 11	<b>050.011</b>	<b>052.111</b>	<b>053.111</b>
<b>162.712 100</b>	12	100	26	16	0.5 - 7	ERC 11	<b>050.011</b>	<b>052.111</b>	<b>053.111</b>
<b>162.714 100</b>	14	100	26	16	0.5 - 7	ERC 11	<b>050.011</b>	<b>052.111</b>	<b>053.111</b>
<b>161.715 100</b>	15.875	100	20	16	0.5 - 7	ERC 11	<b>050.011</b>	<b>052.111</b>	<b>053.111</b>
<b>161.716 040</b>	16	40	20	16	0.5 - 7	ERC 11	<b>050.011</b>	<b>052.111</b>	<b>053.111</b>
<b>161.716 100</b>	16	100	20	16	0.5 - 7	ERC 11	<b>050.011</b>	<b>052.111</b>	<b>053.111</b>
<b>161.716 160</b>	16	160	20	16	0.5 - 7	ERC 11	<b>050.011</b>	<b>052.111</b>	<b>053.111</b>
<b>161.719 100</b>	19.05	100	20	16	0.5 - 7	ERC 11	<b>050.011</b>	<b>052.111</b>	<b>053.111</b>
<b>161.720 100</b>	20	100	20	16	0.5 - 7	ERC 11	<b>050.011</b>	<b>052.111</b>	<b>053.111</b>
<b>161.720 160</b>	20	160	20	16	0.5 - 7	ERC 11	<b>050.011</b>	<b>052.111</b>	<b>053.111</b>
<b>161.722 120</b>	22	120	20	16	0.5 - 7	ERC 11	<b>050.011</b>	<b>052.111</b>	<b>053.111</b>
<b>161.726 120</b>	25.40	120	20	16	0.5 - 7	ERC 11	<b>050.011</b>	<b>052.111</b>	<b>053.111</b>

**ERC 11**

**MANDRINI PORTA PINZE Tipo 162 e 161 CON GHIERA MINI**

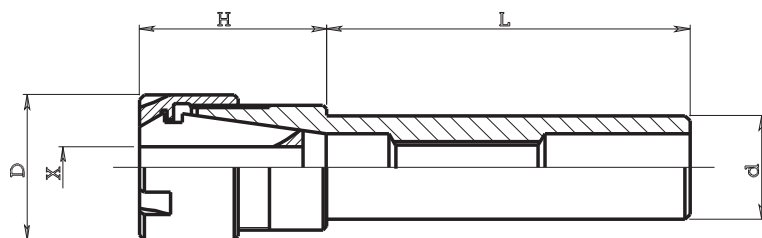
COLLET SPINDLES WITH MINI CLAMPING NUT



Pinze DIN 6499/B  
Collets DIN 6499/B

Art. / Code	d	L	H	D	X	Pinza / Collet	Art. pinza / Collet code	Art. ghiera / Nut code	Art. chiave / Spanner code
162.008 055	8	55	36	22	0.5 - 10	ERC 16	050.016	052.116	053.116
162.008 100	8	100	36	22	0.5 - 10	ERC 16	050.016	052.116	053.116
162.010 060	10	60	36	22	0.5 - 10	ERC 16	050.016	052.116	053.116
162.012 080	12	80	36	22	0.5 - 10	ERC 16	050.016	052.116	053.116
162.014 080	14	80	36	22	0.5 - 10	ERC 16	050.016	052.116	053.116
161.015 034	15.875	34	25	22	0.5 - 10	ERC 16	050.016	052.116	053.116
161.015 060	15.875	60	40	22	0.5 - 10	ERC 16	050.016	052.116	053.116
161.016 034	16	34	25	22	0.5 - 10	ERC 16	050.016	052.116	053.116
161.016 060	16	60	40	22	0.5 - 10	ERC 16	050.016	052.116	053.116
161.016 100	16	100	40	22	0.5 - 10	ERC 16	050.016	052.116	053.116
161.016 160	16	160	40	22	0.5 - 10	ERC 16	050.016	052.116	053.116
161.019 060	19.05	60	24	22	0.5 - 10	ERC 16	050.016	052.116	053.116
161.019 070	19.05	70	24	22	0.5 - 10	ERC 16	050.016	052.116	053.116
161.019 100	19.05	100	24	22	0.5 - 10	ERC 16	050.016	052.116	053.116
161.019 130	19.05	130	24	22	0.5 - 10	ERC 16	050.016	052.116	053.116
161.020 060	20	60	24	22	0.5 - 10	ERC 16	050.016	052.116	053.116
161.020 100	20	100	24	22	0.5 - 10	ERC 16	050.016	052.116	053.116
161.020 130	20	130	24	22	0.5 - 10	ERC 16	050.016	052.116	053.116
161.022 125	22	125	24	22	0.5 - 10	ERC 16	050.016	052.116	053.116
161.023 070	23	70	24	22	0.5 - 10	ERC 16	050.016	052.116	053.116
161.025 060	25	60	24	22	0.5 - 10	ERC 16	050.016	052.116	053.116
161.025 100	25	100	24	22	0.5 - 10	ERC 16	050.016	052.116	053.116
161.025 130	25	130	24	22	0.5 - 10	ERC 16	050.016	052.116	053.116
161.025 160	25	160	24	22	0.5 - 10	ERC 16	050.016	052.116	053.116
161.026 100	25.40	100	24	22	0.5 - 10	ERC 16	050.016	052.116	053.116

ERC 16

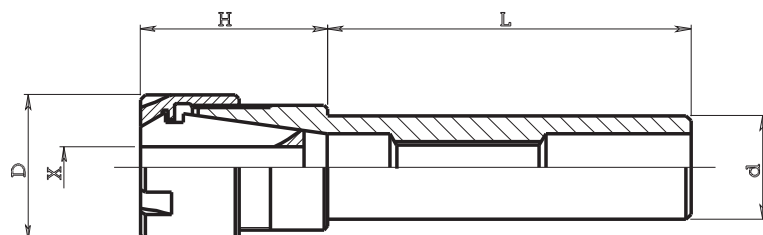

**MANDRINI PORTA PINZE Tipo 162 e 161 CON GHIERA MINI**
**COLLET SPINDLES WITH MINI CLAMPING NUT**

**Pinze DIN 6499/B**  
 Collets DIN 6499/B

Art. / Code	d	L	H	D	X	Pinza / Collet	Art. pinza / Collet code	Art. ghiera / Nut code	Art. chiave / Spanner code
<b>161.116 055</b>	16	55	40	28	0.5 - 13	ERC 20	<b>050.020</b>	<b>052.120</b>	<b>053.120</b>
<b>161.116 100</b>	16	100	40	28	0.5 - 13	ERC 20	<b>050.020</b>	<b>052.120</b>	<b>053.120</b>
<b>161.116 160</b>	16	160	40	28	0.5 - 13	ERC 20	<b>050.020</b>	<b>052.120</b>	<b>053.120</b>
<b>161.119 046</b>	19.05	46	36	28	0.5 - 13	ERC 20	<b>050.020</b>	<b>052.120</b>	<b>053.120</b>
<b>161.119 100</b>	19.05	100	36	28	0.5 - 13	ERC 20	<b>050.020</b>	<b>052.120</b>	<b>053.120</b>
<b>161.119 160</b>	19.05	160	36	28	0.5 - 13	ERC 20	<b>050.020</b>	<b>052.120</b>	<b>053.120</b>
<b>161.120 046</b>	20	46	36	28	0.5 - 13	ERC 20	<b>050.020</b>	<b>052.120</b>	<b>053.120</b>
<b>161.120 100</b>	20	100	36	28	0.5 - 13	ERC 20	<b>050.020</b>	<b>052.120</b>	<b>053.120</b>
<b>161.120 160</b>	20	160	36	28	0.5 - 13	ERC 20	<b>050.020</b>	<b>052.120</b>	<b>053.120</b>
<b>161.122 080</b>	22	80	32	28	0.5 - 13	ERC 20	<b>050.020</b>	<b>052.120</b>	<b>053.120</b>
<b>161.125 070</b>	25	70	26	28	0.5 - 13	ERC 20	<b>050.020</b>	<b>052.120</b>	<b>053.120</b>
<b>161.125 100</b>	25	100	26	28	0.5 - 13	ERC 20	<b>050.020</b>	<b>052.120</b>	<b>053.120</b>
<b>161.125 130</b>	25	130	26	28	0.5 - 13	ERC 20	<b>050.020</b>	<b>052.120</b>	<b>053.120</b>
<b>161.125 160</b>	25	160	26	28	0.5 - 13	ERC 20	<b>050.020</b>	<b>052.120</b>	<b>053.120</b>
<b>161.126 070</b>	25.40	70	26	28	0.5 - 13	ERC 20	<b>050.020</b>	<b>052.120</b>	<b>053.120</b>
<b>161.126 100</b>	25.40	100	26	28	0.5 - 13	ERC 20	<b>050.020</b>	<b>052.120</b>	<b>053.120</b>
<b>161.126 130</b>	25.40	130	26	28	0.5 - 13	ERC 20	<b>050.020</b>	<b>052.120</b>	<b>053.120</b>
<b>161.126 160</b>	25.40	160	26	28	0.5 - 13	ERC 20	<b>050.020</b>	<b>052.120</b>	<b>053.120</b>
<b>161.132 064</b>	32	64	26	28	0.5 - 13	ERC 20	<b>050.020</b>	<b>052.120</b>	<b>053.120</b>
<b>161.132 095</b>	32	95	26	28	0.5 - 13	ERC 20	<b>050.020</b>	<b>052.120</b>	<b>053.120</b>

**ERC 20**



**MANDRINI PORTA PINZE Tipo 162 e 161 CON GHIERA MINI**

COLLET SPINDLES WITH MINI CLAMPING NUT

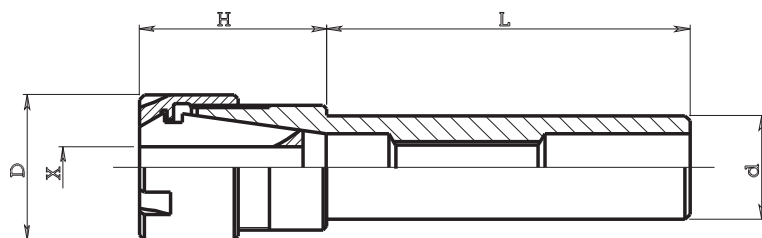

Pinze DIN 6499/B  
Collets DIN 6499/B

Art. / Code	d	L	H	D	X	Pinza / Collet	Art. pinza / Collet code	Art. ghiera / Nut code	Art. chiave / Spanner code
<b>161.219 046</b>	19.05	46	46	35	0.5 - 16	ERC 25	<b>050.025</b>	<b>052.125</b>	<b>053.125</b>
<b>161.219 100</b>	19.05	100	46	35	0.5 - 16	ERC 25	<b>050.025</b>	<b>052.125</b>	<b>053.125</b>
<b>161.220 046</b>	20	46	46	35	0.5 - 16	ERC 25	<b>050.025</b>	<b>052.125</b>	<b>053.125</b>
<b>161.220 060</b>	20	60	46	35	0.5 - 16	ERC 25	<b>050.025</b>	<b>052.125</b>	<b>053.125</b>
<b>161.220 100</b>	20	100	46	35	0.5 - 16	ERC 25	<b>050.025</b>	<b>052.125</b>	<b>053.125</b>
<b>161.220 130</b>	20	130	46	35	0.5 - 16	ERC 25	<b>050.025</b>	<b>052.125</b>	<b>053.125</b>
<b>161.220 160</b>	20	160	46	35	0.5 - 16	ERC 25	<b>050.025</b>	<b>052.125</b>	<b>053.125</b>
<b>161.222 080</b>	22	80	46	35	0.5 - 16	ERC 25	<b>050.025</b>	<b>052.125</b>	<b>053.125</b>
<b>161.225 046</b>	25	46	32	35	0.5 - 16	ERC 25	<b>050.025</b>	<b>052.125</b>	<b>053.125</b>
<b>161.225 070</b>	25	70	32	35	0.5 - 16	ERC 25	<b>050.025</b>	<b>052.125</b>	<b>053.125</b>
<b>161.225 100</b>	25	100	32	35	0.5 - 16	ERC 25	<b>050.025</b>	<b>052.125</b>	<b>053.125</b>
<b>161.225 160</b>	25	160	32	35	0.5 - 16	ERC 25	<b>050.025</b>	<b>052.125</b>	<b>053.125</b>
<b>161.226 046</b>	25.40	46	32	35	0.5 - 16	ERC 25	<b>050.025</b>	<b>052.125</b>	<b>053.125</b>
<b>161.226 070</b>	25.40	70	32	35	0.5 - 16	ERC 25	<b>050.025</b>	<b>052.125</b>	<b>053.125</b>
<b>161.226 100</b>	25.40	100	32	35	0.5 - 16	ERC 25	<b>050.025</b>	<b>052.125</b>	<b>053.125</b>
<b>161.240 100</b>	40	100	27	35	0.5 - 16	ERC 25	<b>050.025</b>	<b>052.125</b>	<b>053.125</b>
<b>161.240 120</b>	40	120	27	35	0.5 - 16	ERC 25	<b>050.025</b>	<b>052.125</b>	<b>053.125</b>

ERC 25

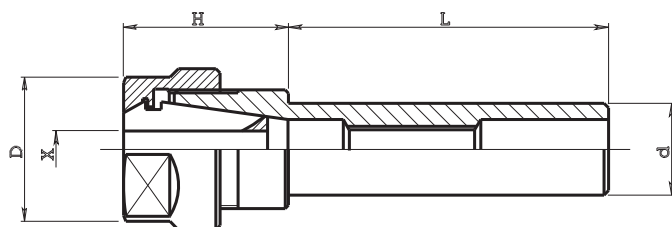
**MANDRINI PORTA PINZE Tipo 160 CON GHIERA ESAGONALE**  
**COLLET SPINDLE WITH HEXAGONAL CLAMPING NUT**

**Pinze DIN 6499/B**  
 Collets DIN 6499/B

Art. / Code	d	L	H	D	X	Pinza / Collet	Art. pinza / Collet code	Art. ghiera / Nut code	Art. chiave / Spanner code
<b>160.015 034</b>	15.875	34	28	28	0.5 - 10	ERC 16	<b>050.016</b>	<b>052.216</b>	<b>053.216</b>
<b>160.015 060</b>	15.875	60	30	28	0.5 - 10	ERC 16	<b>050.016</b>	<b>052.216</b>	<b>053.216</b>
<b>160.016 034</b>	16	34	28	28	0.5 - 10	ERC 16	<b>050.016</b>	<b>052.216</b>	<b>053.216</b>
<b>160.016 060</b>	16	60	30	28	0.5 - 10	ERC 16	<b>050.016</b>	<b>052.216</b>	<b>053.216</b>
<b>160.016 100</b>	16	100	30	28	0.5 - 10	ERC 16	<b>050.016</b>	<b>052.216</b>	<b>053.216</b>
<b>160.016 160</b>	16	160	30	28	0.5 - 10	ERC 16	<b>050.016</b>	<b>052.216</b>	<b>053.216</b>
<b>160.019 046</b>	19.05	46	26	28	0.5 - 10	ERC 16	<b>050.016</b>	<b>052.216</b>	<b>053.216</b>
<b>160.019 100</b>	19.05	100	26	28	0.5 - 10	ERC 16	<b>050.016</b>	<b>052.216</b>	<b>053.216</b>
<b>160.020 046</b>	20	46	26	28	0.5 - 10	ERC 16	<b>050.016</b>	<b>052.216</b>	<b>053.216</b>
<b>160.020 100</b>	20	100	26	28	0.5 - 10	ERC 16	<b>050.016</b>	<b>052.216</b>	<b>053.216</b>
<b>160.020 160</b>	20	160	26	28	0.5 - 10	ERC 16	<b>050.016</b>	<b>052.216</b>	<b>053.216</b>
<b>160.022 046</b>	22	46	26	28	0.5 - 10	ERC 16	<b>050.016</b>	<b>052.216</b>	<b>053.216</b>
<b>160.022 080</b>	22	80	26	28	0.5 - 10	ERC 16	<b>050.016</b>	<b>052.216</b>	<b>053.216</b>
<b>160.022 100</b>	22	100	26	28	0.5 - 10	ERC 16	<b>050.016</b>	<b>052.216</b>	<b>053.216</b>
<b>160.025 070</b>	25	70	24	28	0.5 - 10	ERC 16	<b>050.016</b>	<b>052.216</b>	<b>053.216</b>
<b>160.025 160</b>	25	160	24	28	0.5 - 10	ERC 16	<b>050.016</b>	<b>052.216</b>	<b>053.216</b>
<b>160.026 070</b>	25.40	70	24	28	0.5 - 10	ERC 16	<b>050.016</b>	<b>052.216</b>	<b>053.216</b>
<b>160.032 100</b>	32	100	24	28	0.5 - 10	ERC 16	<b>050.016</b>	<b>052.216</b>	<b>053.216</b>

**ERC 16**

**MANDRINI PORTA PINZE Tipo 160 CON GHIERA ESAGONALE**

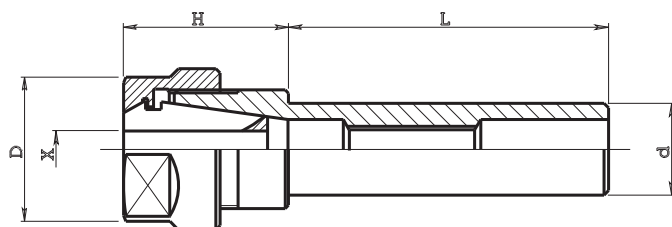
COLLET SPINDLE WITH HEXAGONAL CLAMPING NUT



**Pinze DIN 6499/B**  
 Collets DIN 6499/B

Art. / Code	d	L	H	D	X	Pinza / Collet	Art. pinza / Collet code	Art. ghiera / Nut code	Art. chiave / Spanner code
<b>160.119 046</b>	19.05	46	36	34	0.5 - 13	ERC 20	<b>050.020</b>	<b>052.220</b>	<b>053.220</b>
<b>160.119 100</b>	19.05	100	36	34	0.5 - 13	ERC 20	<b>050.020</b>	<b>052.220</b>	<b>053.220</b>
<b>160.120 046</b>	20	46	36	34	0.5 - 13	ERC 20	<b>050.020</b>	<b>052.220</b>	<b>053.220</b>
<b>160.120 070</b>	20	70	36	34	0.5 - 13	ERC 20	<b>050.020</b>	<b>052.220</b>	<b>053.220</b>
<b>160.120 100</b>	20	100	36	34	0.5 - 13	ERC 20	<b>050.020</b>	<b>052.220</b>	<b>053.220</b>
<b>160.122 046</b>	22	46	26	34	0.5 - 13	ERC 20	<b>050.020</b>	<b>052.220</b>	<b>053.220</b>
<b>160.122 080</b>	22	80	26	34	0.5 - 13	ERC 20	<b>050.020</b>	<b>052.220</b>	<b>053.220</b>
<b>160.125 060</b>	25	60	26	34	0.5 - 13	ERC 20	<b>050.020</b>	<b>052.220</b>	<b>053.220</b>
<b>160.125 080</b>	25	80	26	34	0.5 - 13	ERC 20	<b>050.020</b>	<b>052.220</b>	<b>053.220</b>
<b>160.126 060</b>	25.40	60	26	34	0.5 - 13	ERC 20	<b>050.020</b>	<b>052.220</b>	<b>053.220</b>
<b>160.126 080</b>	25.40	80	26	34	0.5 - 13	ERC 20	<b>050.020</b>	<b>052.220</b>	<b>053.220</b>
<b>160.130 155</b>	30	155	26	34	0.5 - 13	ERC 20	<b>050.020</b>	<b>052.220</b>	<b>053.220</b>
<b>160.132 105</b>	32	105	26	34	0.5 - 13	ERC 20	<b>050.020</b>	<b>052.220</b>	<b>053.220</b>

ERC 20

**MANDRINI PORTA PINZE Tipo 160 CON GHIERA STANDARD**
**COLLET SPINDLE WITH STANDARD CLAMPING NUT**

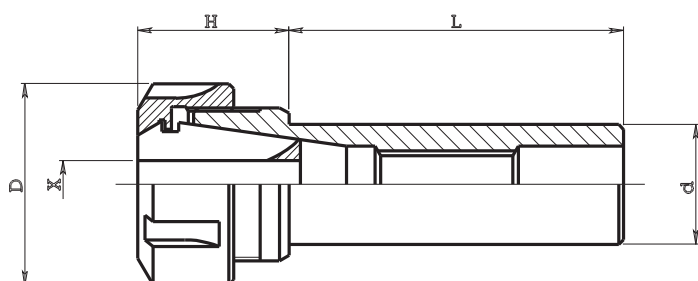
**Pinze DIN 6499/B**  
 Collets DIN 6499/B

Art. / Code	d	L	H	D	X	Pinza / Collet	Art. pinza / Collet code	Art. ghiera / Nut code	Art. chiave / Spanner code
<b>160.219 046</b>	19.05	46	46	42	0.5 - 16	ERC 25	<b>050.025</b>	<b>052.325</b>	<b>053.325</b>
<b>160.219 100</b>	19.05	100	46	42	0.5 - 16	ERC 25	<b>050.025</b>	<b>052.325</b>	<b>053.325</b>
<b>160.220 046</b>	20	46	46	42	0.5 - 16	ERC 25	<b>050.025</b>	<b>052.325</b>	<b>053.325</b>
<b>160.220 100</b>	20	100	46	42	0.5 - 16	ERC 25	<b>050.025</b>	<b>052.325</b>	<b>053.325</b>
<b>160.222 046</b>	22	46	46	42	0.5 - 16	ERC 25	<b>050.025</b>	<b>052.325</b>	<b>053.325</b>
<b>160.222 100</b>	22	100	46	42	0.5 - 16	ERC 25	<b>050.025</b>	<b>052.325</b>	<b>053.325</b>
<b>160.225 050</b>	25	50	32	42	0.5 - 16	ERC 25	<b>050.025</b>	<b>052.325</b>	<b>053.325</b>
<b>160.225 070</b>	25	70	32	42	0.5 - 16	ERC 25	<b>050.025</b>	<b>052.325</b>	<b>053.325</b>
<b>160.225 100</b>	25	100	32	42	0.5 - 16	ERC 25	<b>050.025</b>	<b>052.325</b>	<b>053.325</b>
<b>160.226 050</b>	25.40	50	32	42	0.5 - 16	ERC 25	<b>050.025</b>	<b>052.325</b>	<b>053.325</b>
<b>160.226 070</b>	25.40	70	32	42	0.5 - 16	ERC 25	<b>050.025</b>	<b>052.325</b>	<b>053.325</b>
<b>160.226 100</b>	25.40	100	32	42	0.5 - 16	ERC 25	<b>050.025</b>	<b>052.325</b>	<b>053.325</b>
<b>160.226 120</b>	25.40	120	32	42	0.5 - 16	ERC 25	<b>050.025</b>	<b>052.325</b>	<b>053.325</b>
<b>160.230 070</b>	30	70	32	42	0.5 - 16	ERC 25	<b>050.025</b>	<b>052.325</b>	<b>053.325</b>
<b>160.231 070</b>	31.75	70	32	42	0.5 - 16	ERC 25	<b>050.025</b>	<b>052.325</b>	<b>053.325</b>
<b>160.232 070</b>	32	70	32	42	0.5 - 16	ERC 25	<b>050.025</b>	<b>052.325</b>	<b>053.325</b>
<b>160.232 100</b>	32	100	32	42	0.5 - 16	ERC 25	<b>050.025</b>	<b>052.325</b>	<b>053.325</b>
<b>160.244 155</b>	44.45	155	28	42	0.5 - 16	ERC 25	<b>050.025</b>	<b>052.325</b>	<b>053.325</b>

**ERC 25**

**MANDRINI PORTA PINZE Tipo 160 CON GHIERA STANDARD**

COLLET SPINDLE WITH STANDARD CLAMPING NUT

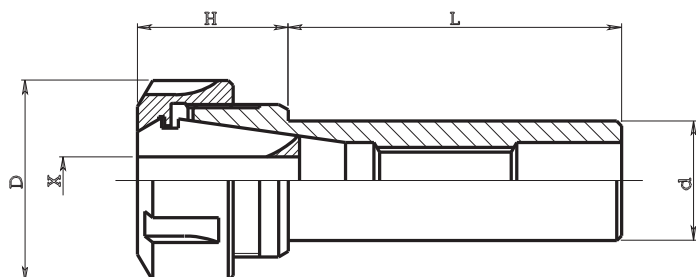

Pinze DIN 6499/B  
Collets DIN 6499/B

Art. / Code	d	L	H	D	X	Pinza / Collet	Art. pinza / Collet code	Art. ghiera / Nut code	Art. chiave / Spanner code
160.319 050	19.05	50	53	50	1 - 20	ERC 32	050.032	052.332	053.332
160.320 050	20	50	53	50	1 - 20	ERC 32	050.032	052.332	053.332
160.322 050	22	50	53	50	1 - 20	ERC 32	050.032	052.332	053.332
160.325 050	25	50	53	50	1 - 20	ERC 32	050.032	052.332	053.332
160.325 070	25	70	53	50	1 - 20	ERC 32	050.032	052.332	053.332
160.325 100	25	100	53	50	1 - 20	ERC 32	050.032	052.332	053.332
160.326 050	25.40	50	53	50	1 - 20	ERC 32	050.032	052.332	053.332
160.326 070	25.40	70	53	50	1 - 20	ERC 32	050.032	052.332	053.332
160.326 100	25.40	100	53	50	1 - 20	ERC 32	050.032	052.332	053.332
160.330 050	30	50	45	50	1 - 20	ERC 32	050.032	052.332	053.332
160.330 070	30	70	45	50	1 - 20	ERC 32	050.032	052.332	053.332
160.330 140	30	140	45	50	1 - 20	ERC 32	050.032	052.332	053.332
160.331 050	31.75	50	45	50	1 - 20	ERC 32	050.032	052.332	053.332
160.331 070	31.75	70	45	50	1 - 20	ERC 32	050.032	052.332	053.332
160.332 050	32	50	45	50	1 - 20	ERC 32	050.032	052.332	053.332
160.332 070	32	70	45	50	1 - 20	ERC 32	050.032	052.332	053.332
160.332 100	32	100	45	50	1 - 20	ERC 32	050.032	052.332	053.332
160.332 140	32	140	45	50	1 - 20	ERC 32	050.032	052.332	053.332
160.335 050	35	50	27	50	1 - 20	ERC 32	050.032	052.332	053.332
160.335 070	35	70	27	50	1 - 20	ERC 32	050.032	052.332	053.332
160.338 140	38.10	140	45	50	1 - 20	ERC 32	050.032	052.332	053.332
160.340 085	40	85	45	50	1 - 20	ERC 32	050.032	052.332	053.332
160.340 155	40	155	30	50	1 - 20	ERC 32	050.032	052.332	053.332
160.344 085	44.45	85	45	50	1 - 20	ERC 32	050.032	052.332	053.332
160.344 155	44.45	155	30	50	1 - 20	ERC 32	050.032	052.332	053.332
160.350 155	50	155	30	50	1 - 20	ERC 32	050.032	052.332	053.332
160.351 155	50.80	155	30	50	1 - 20	ERC 32	050.032	052.332	053.332
160.360 155	60	155	30	50	1 - 20	ERC 32	050.032	052.332	053.332
160.363 155	63.50	155	30	50	1 - 20	ERC 32	050.032	052.332	053.332

ERC 32

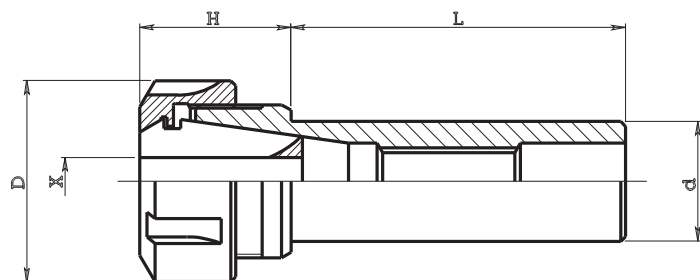
**MANDRINI PORTA PINZE Tipo 160 CON GHIERA STANDARD**
**COLLET SPINDLE WITH STANDARD CLAMPING NUT**

**Pinze DIN 6499/B**  
 Collets DIN 6499/B

Art. / Code	d	L	H	D	X	Pinza / Collet	Art. pinza / Collet code	Art. ghiera / Nut code	Art. chiave / Spanner code
<b>160.425 050</b>	25	50	60	63	2 - 30	ERC 40	<b>050.040</b>	<b>052.340</b>	<b>053.340</b>
<b>160.426 050</b>	25.40	50	60	63	2 - 30	ERC 40	<b>050.040</b>	<b>052.340</b>	<b>053.340</b>
<b>160.431 050</b>	31.75	50	60	63	2 - 30	ERC 40	<b>050.040</b>	<b>052.340</b>	<b>053.340</b>
<b>160.431 070</b>	31.75	70	60	63	2 - 30	ERC 40	<b>050.040</b>	<b>052.340</b>	<b>053.340</b>
<b>160.432 070</b>	32	70	60	63	2 - 30	ERC 40	<b>050.040</b>	<b>052.340</b>	<b>053.340</b>
<b>160.438 155</b>	38.10	155	60	63	2 - 30	ERC 40	<b>050.040</b>	<b>052.340</b>	<b>053.340</b>
<b>160.440 050</b>	40	50	60	63	2 - 30	ERC 40	<b>050.040</b>	<b>052.340</b>	<b>053.340</b>
<b>160.440 080</b>	40	80	60	63	2 - 30	ERC 40	<b>050.040</b>	<b>052.340</b>	<b>053.340</b>
<b>160.440 155</b>	40	155	60	63	2 - 30	ERC 40	<b>050.040</b>	<b>052.340</b>	<b>053.340</b>
<b>160.444 155</b>	44.45	155	45	63	2 - 30	ERC 40	<b>050.040</b>	<b>052.340</b>	<b>053.340</b>
<b>160.450 170</b>	50	170	35	63	2 - 30	ERC 40	<b>050.040</b>	<b>052.340</b>	<b>053.340</b>
<b>160.451 170</b>	50.80	170	35	63	2 - 30	ERC 40	<b>050.040</b>	<b>052.340</b>	<b>053.340</b>
<b>160.460 170</b>	60	170	35	63	2 - 30	ERC 40	<b>050.040</b>	<b>052.340</b>	<b>053.340</b>
<b>160.463 170</b>	63.50	170	35	63	2 - 30	ERC 40	<b>050.040</b>	<b>052.340</b>	<b>053.340</b>

**ERC 40**

**MANDRINI PORTA PINZA A CONO MORSE Tipo 163**  
MORSE TAPER SHANK COLLET CHUCKS

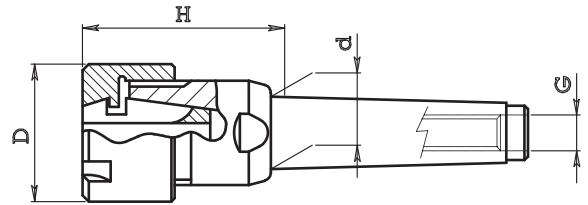
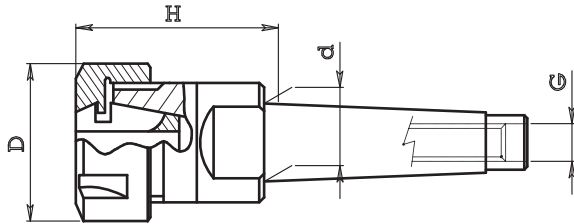
**Pinze DIN 6499/B**  
Collets DIN 6499/B



**GHIERA STANDARD - STANDARD NUT**

Art. / Code	C.M. / M.T.	d	G	H	D	Pinza / Collet	Art. pinza / Collet code
163.701	C.M.1	12.065	M6	25	19	ERC 11	050.011
163.001	C.M.1	12.065	M6	40	28	ERC 16	050.016
163.002	C.M.2	17.780	M10	42	28	ERC 16	050.016
163.102	C.M.2	17.780	M10	50	34	ERC 20	050.020
163.202	C.M.2	17.780	M10	54	42	ERC 25	050.025
163.203	C.M.3	23.825	M12	53	42	ERC 25	050.025
163.303	C.M.3	23.825	M12	70	50	ERC 32	050.032
163.403	C.M.3	23.825	M12	80	63	ERC 40	050.040
163.304	C.M.4	31.267	M16	60	50	ERC 32	050.032
163.404	C.M.4	31.267	M16	81	63	ERC 40	050.040

**GHIERA MINI - MINI NUT**

Art. / Code	C.M. / M.T.	d	G	H	D	Pinza / Collet	Art. pinza / Collet code
164.701	C.M.1	12.065	M6	25	16	ERC 11	050.011
164.001	C.M.1	12.065	M6	40	22	ERC 16	050.016
164.002	C.M.2	17.780	M10	42	22	ERC 16	050.016
164.102	C.M.2	17.780	M10	50	28	ERC 20	050.020
164.202	C.M.2	17.780	M10	54	35	ERC 25	050.025
164.003	C.M.3	23.825	M12	43	22	ERC 16	050.016
164.103	C.M.3	23.825	M12	47	28	ERC 20	050.020
164.203	C.M.3	23.825	M12	58	35	ERC 25	050.025

**MANDRINO PORTA PINZE CON GHIERA MINI**  
COLLET SPINDLE WITH MINI CLAMPING NUT

**Pinze DIN 6499/B**  
Collets DIN 6499/B

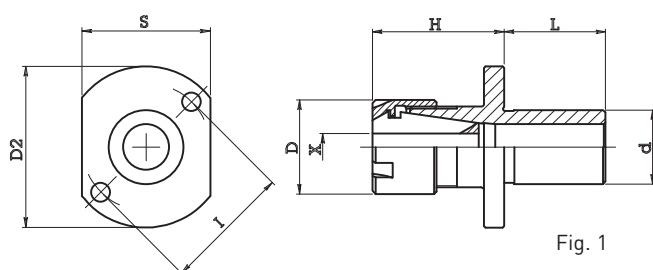

Fig. 1

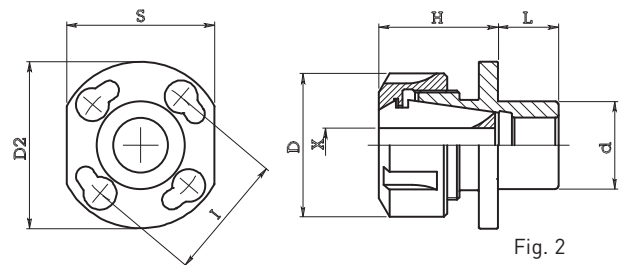

Fig. 2

	Art. / Code	d	L	H	D	X	D2	S	I	Pinza / Collet	Art. pinza / Collet code	Art. ghiera / Nut code	Fig.
STAR 20	165.712.026	12	26	16.5	16	0.5 - 7	46	20	34	ERC 11	050.011	052.011	1
	165.016.021	16	21	28	22	0.5 - 10	40	24	31	ERC 16	050.016	052.116	1
STAR SR 20	165.022.025	22	25	39	22	0.5 - 10	49	28	40	ERC 16	050.016	052.116	1
STAR SR 32	165.122.025	22	25	40	28	0.5 - 13	49	28	40	ERC 20	050.020	052.120	1
STAR SR 20	165.122.030	22	30	35	28	0.5 - 13	48	38	38	ERC 20	050.020	052.120	1
STAR SR 32	165.122.030B	22	30	35	28	0.5 - 13	60	38	50	ERC 20	050.020	052.120	1
GILDEM. GM32-35-42	166.332.022	32	22	36	50	1 - 20	61	54	46	ERC 32	050.032	052.332	2



**PORTA PINZA A CENTRATURA REGOLABILE**  
**ADJUSTABLE COLLET CHUCKS**

n.4 Filetti per registrare la centratura

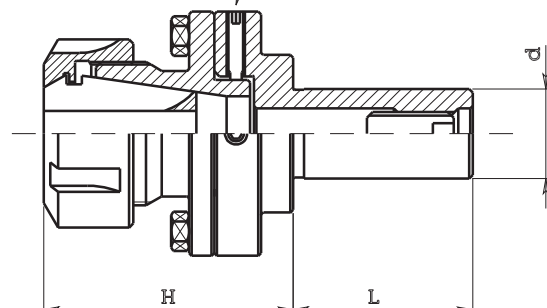
**Pinze DIN 6499/B**  
 Collets DIN 6499/B

Art. / Code	d	H	L	Pinza / Collet	Art. pinza / Collet code
154.219	19.05	42	44	ERC 20	050.020
154.220	20	42	44	ERC 20	050.020
154.322	22	57	50	ERC 32	050.032
154.325	25	57	50	ERC 32	050.032
154.326	25.40	57	50	ERC 32	050.032
154.330	30	57	50	ERC 32	050.032
154.331	31.75	57	50	ERC 32	050.032
154.332	32	57	50	ERC 32	050.032

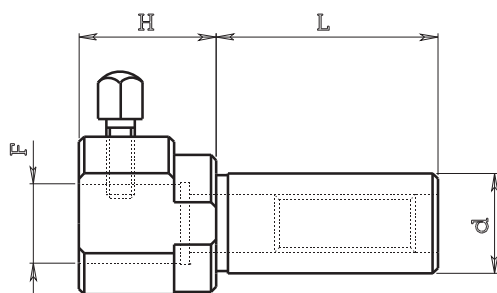
**PORTA UTENSILI PER PUNTE CILINDRICHE Tipo 152**  
**TOOLHOLDER FOR CYLINDRICAL SHANK DRILLS**

Art. / Code	d	H	L	F
152.219	19.05	26	32	15
152.220	20	26	46	15
152.325	25	40	46	25
152.326	25.40	40	46	25

# CHIA-MO

WWW.CHIAMO.IT

I T A L Y



**CHIA-MO srl**

Via Caduti di Sabbiano, 12  
40011 Anzola dell'Emilia (Bo) Italy  
Tel. +39 051 734153 - Fax +39 051 734958  
info@chiamo.it - www.chiamo.it

