









ATTACCO
COUPLING
ACCOUPEMENT
KUPPLUNG



M

M38	Version	Tools Clamping	Center Height	Max. speed	Ratio	External	Internal	Page
	0°	ER16 - DIN6499 ER25 - DIN6499 ER16 - DIN6499 Ø16mm - DIN6358		6000rpm 6000rpm 24000rpm 6000rpm	i=1:1 i=1:1 i=1:4 i=1:1	RAPPS 16 121UM38 RAPPS 25 121UM38 RAPPS 16 122UM38 RAPPS 16 121UM38	RAPPS 16 131UM38 RAPPS 25 131UM38	17 17 18 18
	90°	ER16 - DIN6499 ER20 - DIN6499 ER16 - DIN6499 Ø16mm - DIN6358	59mm 59mm 59mm 59mm	6000rpm 6000rpm 24000rpm 6000rpm	i=1:1 i=1:1 i=1:4 i=1:1	RRPPS 16 121UM38 RRPPS 20 121UM38 RRPPS 16 122UM38 RRPPS 16 122UM38	RRPPS 16 131UM38 RRPPS 20 131UM38	19 19 20 20
	±90°	ER16 - DIN6499		6000rpm	i=1:1	ROPSS 16 121UM38	ROPSS 16 131UM38	22

M45	Version	Tools Clamping	Center Height	Max. speed	Ratio	External	Internal	Page
	0°	ER25 - DIN6499 ER32 - DIN6499 ER16 - DIN6499 Ø16mm - DIN6358		6000rpm 6000rpm 24000rpm 6000rpm	i=1:1 i=1:1 i=1:4 i=1:1	RAPPS 25 121UM45 RAPPS 32 121UM45 RAPPS 16 122UM45 RAPPS 16 121UM45	RAPPS 25 131UM45 RAPPS 32 131UM45	17 17 18 18
	90°	ER25 - DIN6499 ER16 - DIN6499 Ø16mm - DIN6358	65mm 65mm 65mm	6000rpm 24000rpm 6000rpm	i=1:1 i=1:4 i=1:1	RRPPS 25 121UM45 RRPPS 16 122UM45 RRPPS 16 121UM45	RRPPS 25 131UM45	19 20 20
	90° Double	ER25 - DIN6499	65mm	6000rpm	i=1:1	RRPPT 25 121UM45		21
	±90°	ER20 - DIN6499		6000rpm	i=1:1	ROPSS 20 121UM45	ROPSS 20 131UM45	22

M54	Version	Tools Clamping	Center Height	Max. speed	Ratio	External	Internal	Page
	0°	ER25 - DIN6499 ER32 - DIN6499 ER16 - DIN6499 Ø22mm - DIN6358		6000rpm 6000rpm 24000rpm 6000rpm	i=1:1 i=1:1 i=1:4 i=1:1	RAPPS 25 121UM54 RAPPS 32 121UM54 RAPPS 16 122UM54 RAPPS 22 121UM54	RAPPS 25 131UM54 RAPPS 32 131UM54	17 17 18 18
	90°	ER25 - DIN6499 ER32 - DIN6499 ER16 - DIN6499 Ø22mm - DIN6358	75mm 75mm 75mm 75mm	6000rpm 6000rpm 24000rpm 6000rpm	i=1:1 i=1:1 i=1:4 i=1:1	RRPPS 25 321UM54 RRPPS 32 321UM54 RRPPS 16 122UM54 RRPPS 22 121UM54	RRPPS 25 331UM54 RRPPS 32 331UM54	19 19 20 20
	90° Double	ER25 - DIN6499 ER32 - DIN6499	75mm 75mm	6000rpm 6000rpm	i=1:1 i=1:1	RRPPT 25 321UM54 RRPPT 32 321UM54		21 21
	±90°	ER20 - DIN6499		6000rpm	i=1:1	ROPSS 20 121UM54	ROPSS 20 131UM54	22

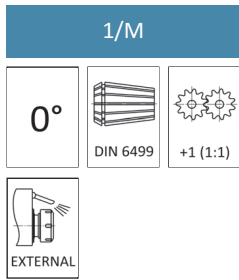
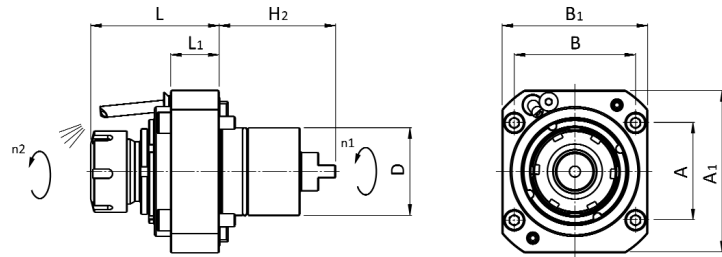



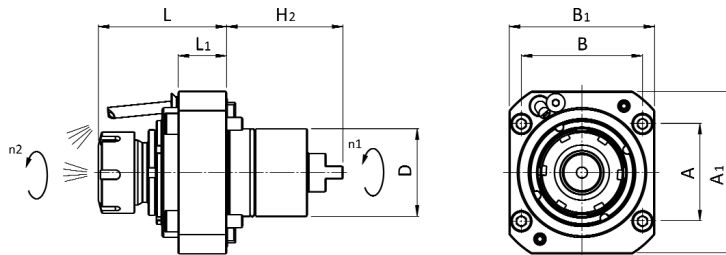

Codice code - code - Bestell Nr.	D	ER	H	H1	H2	L (min-max)	L1	L2	A	B	A1	B1	A2	B2	M ₂ Nm	n ₂ min-1	P kW
RAPPS 16 121UM38	38	16			37	66,3÷70	40		52	56	78	80			25	6000	6
RAPPS 25 121UM38	38	25			37	69÷72,7	40		52	56	78	80			25	6000	6
RAPPS 25 121UM45	45	25			76	53,9÷57,6	25		68	56	92	70			35	6000	6
RAPPS 32 121UM45	45	32			76	60,6÷64,3	25		68	56	92	70			35	6000	6
RAPPS 25 121UM54	54	25			72	73,5÷77,2	30		60	75	100	90			60	6000	10
RAPPS 32 121UM54	54	32			72	75,7÷79,4	30		60	75	100	90			60	6000	10

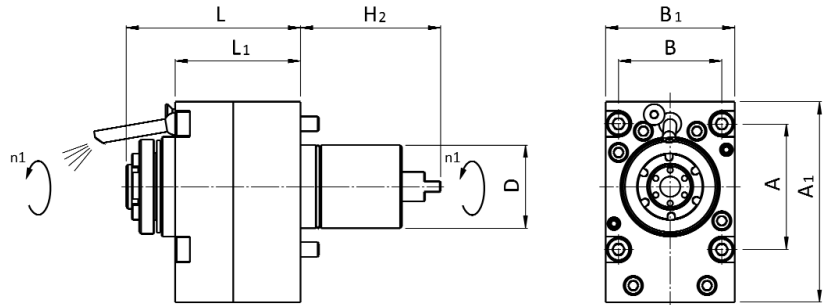



M

Codice code - code - Bestell Nr.	D	ER	H	H1	H2	L (min-max)	L1	L2	A	B	A1	B1	A2	B2	M ₂ Nm	n ₂ min-1	P kW
RAPPS 16 131UM38	38	16			37	66,3÷70	40		52	56	78	80			25	6000	6
RAPPS 25 131UM38	38	25			37	69÷72,7	40		52	56	78	80			25	6000	6
RAPPS 25 131UM45	45	25			76	53,9÷57,6	25		68	56	92	70			35	6000	6
RAPPS 32 131UM45	45	32			76	60,6÷64,3	25		68	56	92	70			35	6000	6
RAPPS 25 131UM54	54	25			72	73,5÷77,2	30		60	75	100	90			60	6000	10
RAPPS 32 131UM54	54	32			72	75,7÷79,4	30		60	75	100	90			60	6000	10

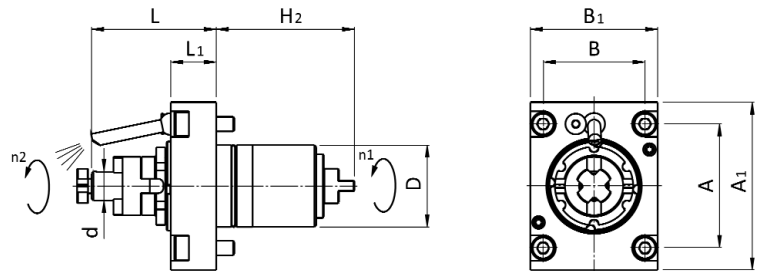
M

3/M			Codice code - code - Bestell Nr.	D	ER	H	H1	H2	L (min-max)	L1	L2	A	B	A1	B1	A2	B2	M ₂ Nm	n ₂ min-1	P kW
 0°  DIN 6499  +4 (1:4)	 EXTERNAL	RAPPS 16 122UM38	38	16			37	90,8-94,5	68			52	56	108,5	70			6	24000	3
		RAPPS 16 122UM45	45	16			76	90,8-94,5	68			68	56	108,5	70			6	24000	3
		RAPPS 16 122UM54	54	16			72	90,8-94,5	68			60	75	108,5	70			6	24000	3



4/M			Codice code - code - Bestell Nr.	D	d	H	H1	H2	L	L1	L2	A	B	A1	B1	A2	B2	M ₂ Nm	n ₂ min-1	P kW
 0°  DIN 6358  +1 (1:1)	 EXTERNAL	RAPPS 16 121UM38	38	Ø16			37	68,5	25			52	56	78	80			25	6000	6
		RAPFS 16 121UM45	45	Ø16			76	68,5	25			68	56	92	70			35	6000	6
		RAPPS 22 121UM54	54	Ø22			72	100	35			60	75	100	90			60	6000	10

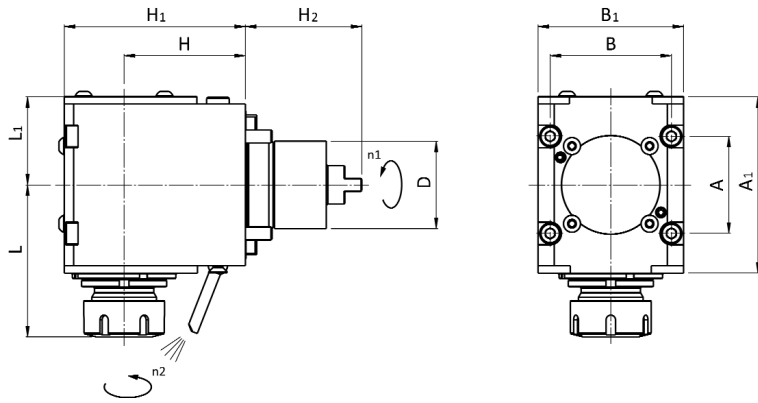

5/M

90°

DIN 6499

-1 (1:1)

EXTERNAL

Codice code - code - Bestell Nr.	D	ER	H	H1	H2	L (min-max)	L1	L2	A	B	A1	B1	A2	B2	M ₂ Nm	n ₂ min-1	P kW
RRPPS 16 121UM38	38	16	59	84	37	65,3-69	45		52	56	78	80			25	6000	6
RRPPS 20 121UM38	38	20	59	84	37	65,3-69	45		52	56	78	80			25	6000	6
RRPPS 25 121UM45	45	25	65	95	76	80,9-84,6	52,2		68	56	92	70			35	6000	6
RRPPS 25 321UM54	54	25	75	112	72	87,3-91	54,5		60	75	100	90			60	6000	10
RRPPS 32 321UM54	54	32	75	112	72	90,3-94	54,5		60	75	100	90			60	6000	10

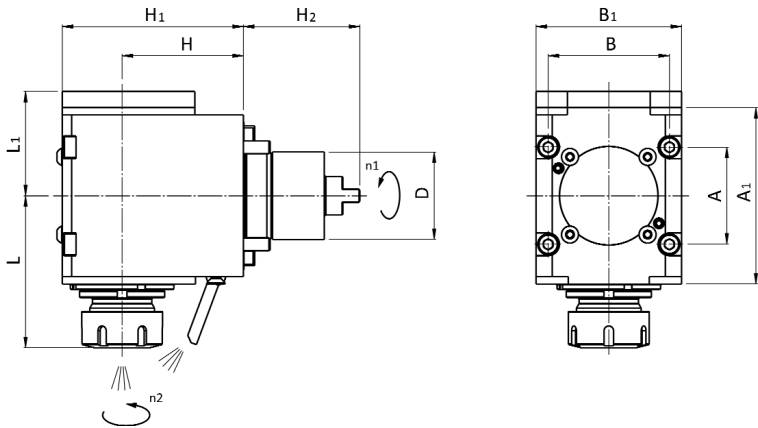
M

6/M

90°

DIN 6499

-1 (1:1)

INT./EXT.

80 bar

Filtration
30µm

Codice code - code - Bestell Nr.	D	ER	H	H1	H2	L (min-max)	L1	L2	A	B	A1	B1	A2	B2	M ₂ Nm	n ₂ min-1	P kW
RRPPS 16 131UM38	38	16	59	84	37	65,3-69	45		52	56	78	80			25	6000	6
RRPPS 20 131UM38	38	20	59	84	37	65,3-69	45		52	56	78	80			25	6000	6
RRPPS 25 131UM45	45	25	65	95	76	80,9-84,6	52,2		68	56	92	70			35	6000	6
RRPPS 25 331UM54	54	25	75	112	72	87,3-91	64,5		60	75	100	90			60	6000	10
RRPPS 32 331UM54	54	32	75	112	72	90,3-94	64,5		60	75	100	90			60	6000	10

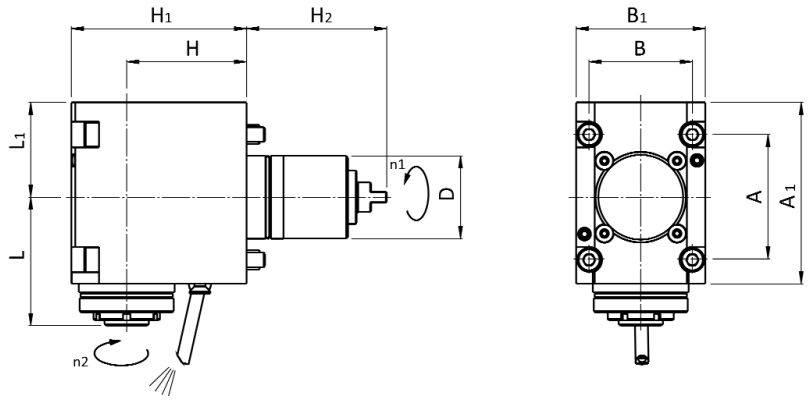
M



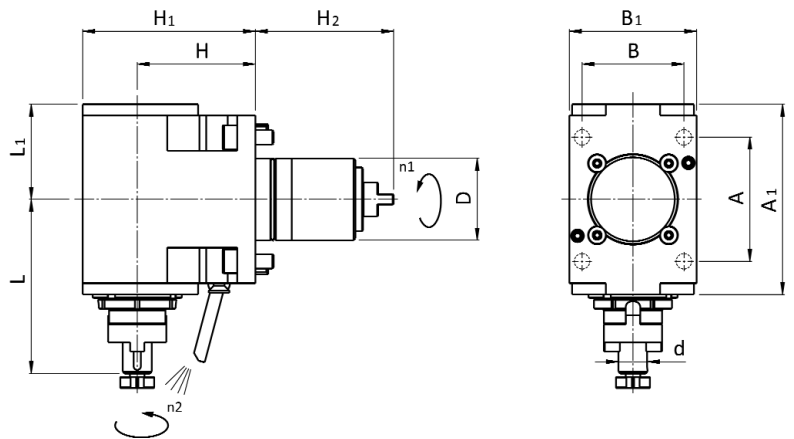
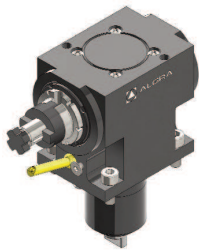

7/M			Codice code - code - Bestell Nr.	D	ER	H	H1	H2	L (min-max)	L1	L2	A	B	A1	B1	A2	B2	M ₂ Nm	n ₂ min-1	P kW
90°			RRPPS 16 122UM38	38	16	59	89	97	66-69,7	51,5		52	56	98,5	80			6	24000	3
			RRPPS 16 122UM45	45	16	65	95	76	66-69,7	51,5		68	56	98,5	70			6	24000	3
			RRPPS 16 122UM54	54	16	75	112	72	66-69,7	51,5		60	75	98,5	90			6	24000	3

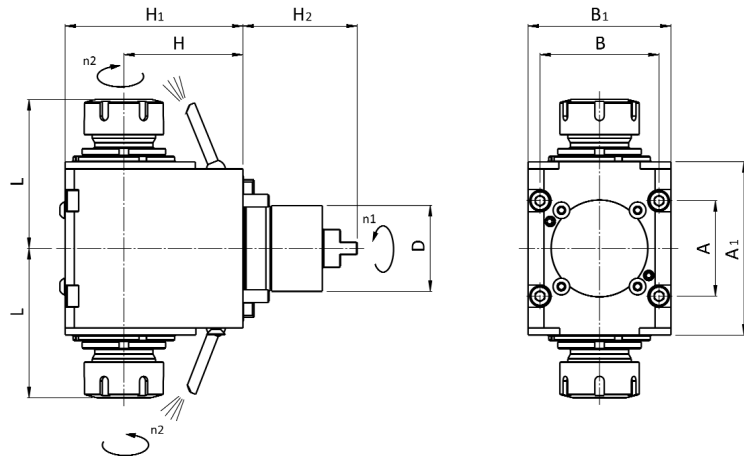

8/M			Codice code - code - Bestell Nr.	D	d	H	H1	H2	L	L1	L2	A	B	A1	B1	A2	B2	M ₂ Nm	n ₂ min-1	P kW
90°			RRPFS 16 121UM38	38	Ø16	59	84	37	95,6	55		52	56	78	80			25	6000	6
			RRPFS 16 121UM45	45	Ø16	65	95	76	95,6	52,2		68	56	92	70			35	6000	6
			RRPFS 22 121UM54	54	Ø22	75	112	72	102	58		60	75	100	90			60	6000	10





9/M		Codice code - code - Bestell Nr.	D	ER	H	H1	H2	L (min-max)	L1	L2	A	B	A1	B1	A2	B2	M ₂ Nm	n ₂ min-1	P kW
 90°  DIN 6499  ±1 (1:1)	 EXTERNAL	RRPPT 25 121UM45	45	25	65	95	76	80,9-84,6			68	56	92	70			35	6000	6
		RRPPT 25 321UM54	54	25	75	112	72	87,3-91			60	75	100	90			60	6000	10
		RRPPT 32 321UM54	54	32	75	112	72	90,2-93,9			60	75	100	90			60	6000	10

M

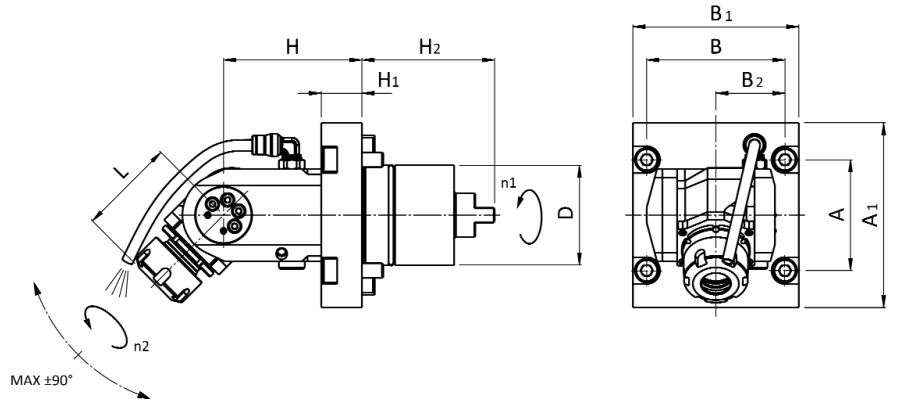
M

10/M			Codice code - code - Bestell Nr.	D	ER	H	H1	H2	L (min-max)	L1	L2	A	B	A1	B1	A2	B2	M ₂ Nm	n ₂ min-1	P kW
 			ROPPS 16 121UM38	38	16	60	17,5	37	52,3-56			52	56	78	80		28	10	6000	2
			ROPPS 20 121UM45	45	20	65	12	76	48,8-52,5			68	56	92	70		28	15	6000	3
			ROPPS 20 121UM54	54	20	75	22	72	48,8-52,5			60	75	100	90		37,5	15	6000	3

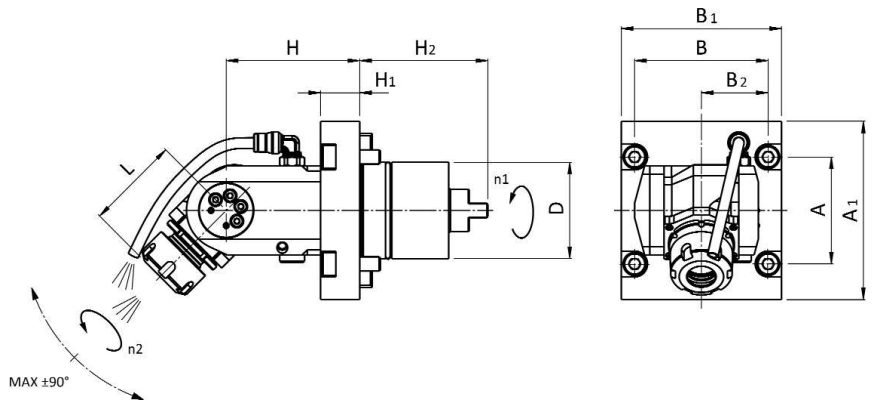

11/M			Codice code - code - Bestell Nr.	D	ER	H	H1	H2	L (min-max)	L1	L2	A	B	A1	B1	A2	B2	M ₂ Nm	n ₂ min-1	P kW
 			ROPPS 16 131UM38	38	16	60	17,5	37	52,3-56			52	56	78	80		28	10	6000	2
			ROPPS 20 131UM45	45	20	65	12	76	48,8-52,5			68	56	92	70		28	15	6000	3
			ROPPS 20 131UM54	54	20	75	22	72	48,8-52,5			60	75	100	90		37,5	15	6000	3